

RETAIL PRICELIST 2026

Built on trust,
Growing together



April 2026



Smart Innovation: Around The World

Legrand Group is a global specialist in electrical and digital building infrastructure, offering smart solutions across the residential, commercial, hospitality, and industrial sectors. This strong capability has positioned Legrand as the preferred choice of discerning customers in nearly 180 countries worldwide.

Our purpose is to improve lives by transforming the spaces where people live, work and meet by delivering electrical and digital infrastructures and connected solutions that are simple, innovative and sustainable.

Guided by its philosophy of “Listen, Design, Make, and Support”, Legrand closely tracks evolving lifestyles and customer needs. The Group designs high value-added products that seamlessly integrate advanced technology, ergonomic excellence, and refined aesthetics. Through smart ideas, sleek designs, and intuitive simplicity, Legrand aims to help every customer experience a simpler, better quality of life.

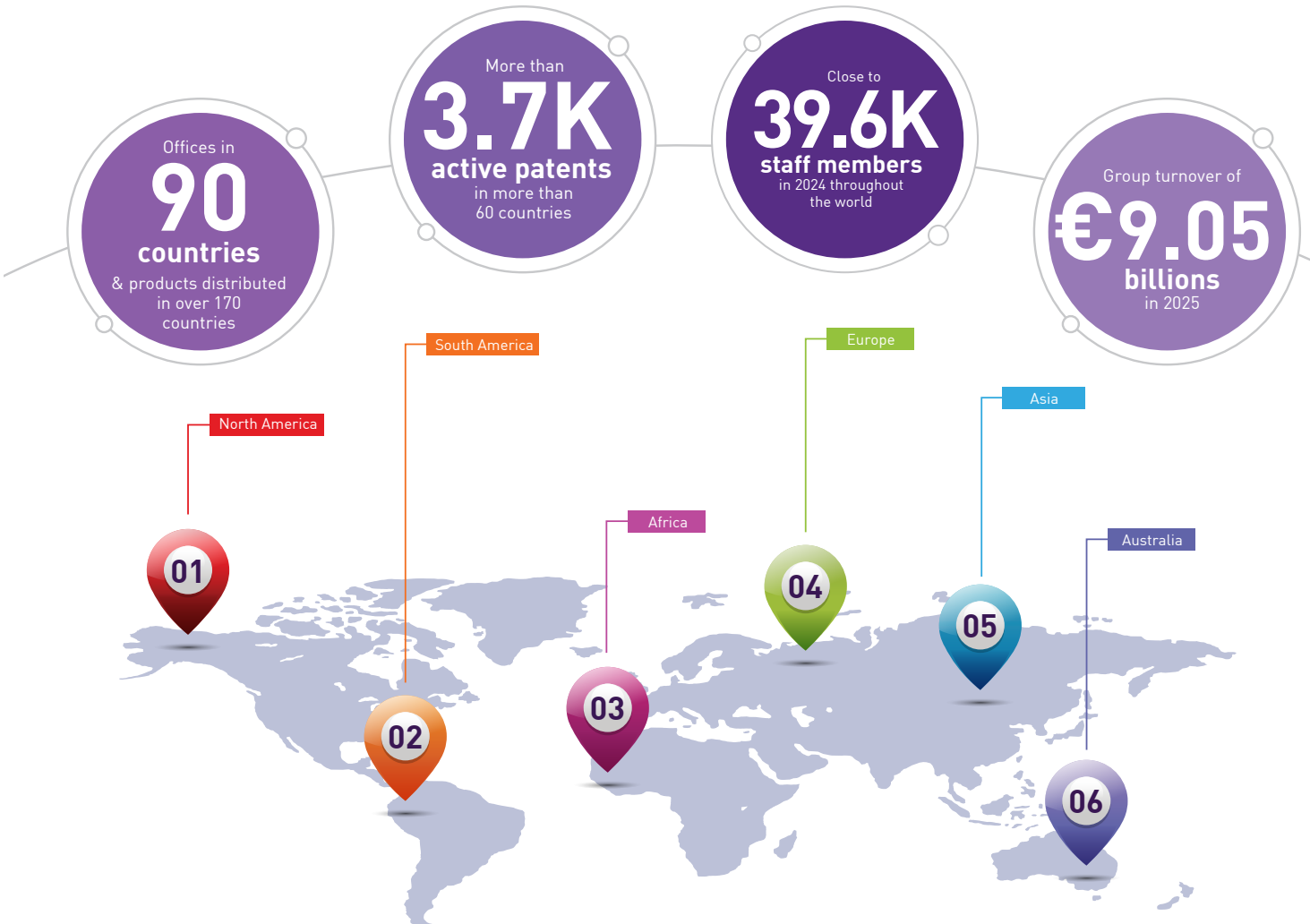

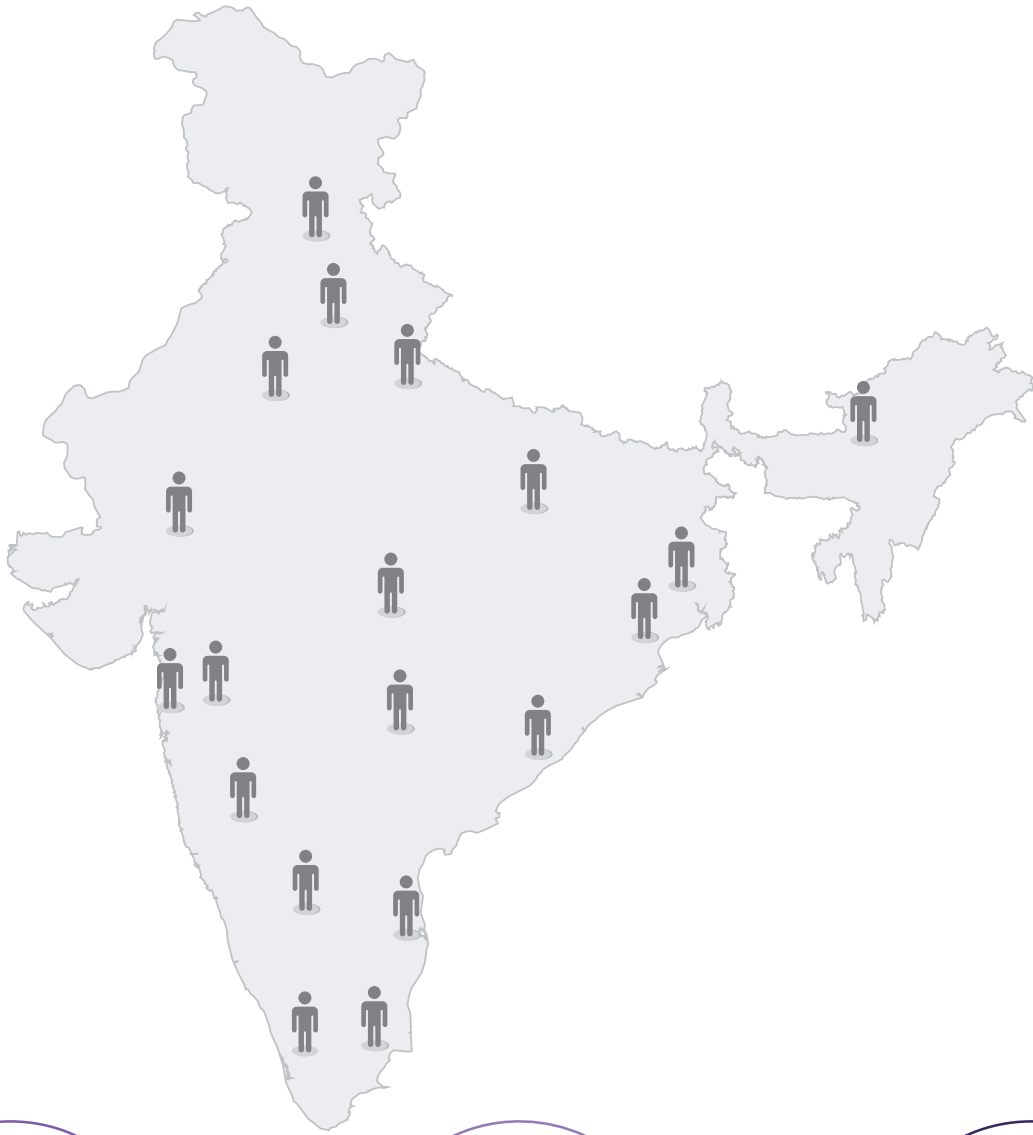

91+ OFFICES
spread across
the country

OVER 5000+
EMPLOYEES
in India

07
MANUFACTURING
facilities

3
R&D
centers

22
INNOVALS
& **3 CENTERS OF**
EXCELLENCE

An extensive network of over **870**
distribution partners and **18000** retailers

The Global Specialist

A comprehensive solution for your Electrical and Digital Building Infrastructure.

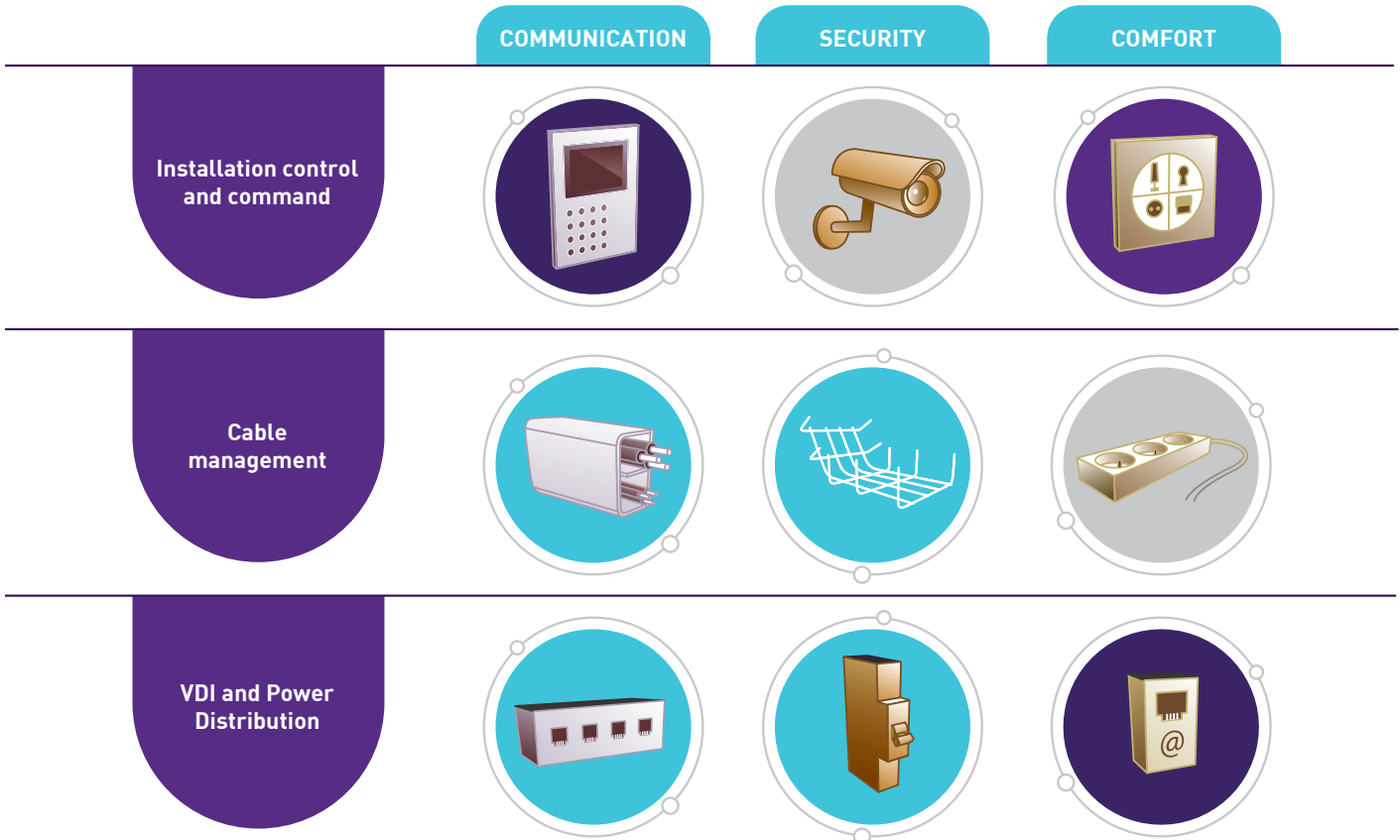

Global Specialist in Electrical and Digital Building Infrastructure

Legrand is a global specialist in electrical and digital building infrastructures, delivering solutions for homes, data centers, commercial, healthcare, hospitality, and industrial spaces. With nearly 300,000 product references, Legrand holds No. 1 or No. 2 positions in most markets worldwide.

Continuous Innovation

Over 2200 people work at our engineering and design offices, innovating simple and sustainable solutions.

Product Design – A lever for differentiation

Design is integral to our overall strategy and lies at the core of everything we do at Legrand. More than aesthetics alone, design is about enhancing the overall customer experience.

A Landmark Infrastructure Built with Purpose, Rooted in Trust



A massive infrastructure spanning 30000+ sqm, one of the largest factories for Legrand worldwide and India, was inaugurated recently at Nashik, Maharashtra. This factory assumes great significance not just for its investments and massive scale but also for its growth lever placing India at the centre of the Group's ambitions. The factory will soon be a certified green building by IGBC, with a 1 MW roof top solar installation and has been thoughtfully designed, keeping sustainability at the core of its planning.

PRODUCTS:

Our new Nashik factory is designed to manufacture Bus Bar Trunking Systems (BBTS), Distribution Boards (DBs), Server Racks, Cablofil and Industrial plugs and sockets. The factory is all set to supply products both to the local market and for export, with shipments of BBTs and industrial plug and sockets already reaching international destinations. Plans are in place to expand exports to include DBs and Cablofil products, positioning our India factory as a global supply hub with significant capacity and agility.



Our Values to Improve Lives



WE SEIZE THE FUTURE

We seize the future by creating lasting, high performance solutions for every kind of building, driven by the vision and talent of our teams



WE EMBRACE INCLUSION

We embrace inclusion by welcoming diversity among our customers, our people, and our partners, and turning it into a strength and opportunity



WE MOVE IN SYNC

We grow stronger together - collaborating with people, brands, and partners to shape a connected and future-ready electrical ecosystem



WE STRIVE FOR SIMPLICITY

We turn challenges into opportunities, creating purposeful innovations that deliver real value across every corner of the electrical sector



WE ARE DEPENDABLE

We are dependable, guided by reliability and sustainability. For over 150 years, we've built trust through responsible design and ethical relationships with our customers

Our Commitment to Sustainability



At Legrand, sustainability is a key consideration in our product development process. Every product is crafted with a **"Eco Design"** approach, blending innovation with eco-friendly practices right from the start.

Our Product Environmental Profile (PEP) offers clear and reliable insights into the environmental impact of our products. By supporting green building initiatives and promoting eco-conscious choices, we ensure every product plays a role in building a more sustainable future.



A Landmark Infrastructure Built with Purpose, Rooted in Trust

Community Initiatives

Legrand Empowering Scholarship

Program Started in 2018, this initiative supports meritorious girl students from lower socio-economic backgrounds in Engineering, Architecture, Science, and Technology. To date, over 700+ students have been enrolled, including 66 differently abled and 25 LGBTQ+ students.

Annually, more than 100 new scholarships are awarded. Additionally, each year over 50 students receive mentorship assistance from Legrand Subject Matter Experts, till date over 150 students have been mentored to be the Future Women Leaders.



Legrand Telemedicine Center

Through our 3 centres located in Jalgaon, Haridwar, and Rohad, we offer free consultations, tests, and medicines in partnership with Apollo Hospitals. This initiative benefits over 10,000 community members annually and has positively impacted more than 72000 lives to date.

Center of Excellence - Mathura, Dehradun & Bangalore

The centers at Mathura, ITI Niranjapur, Dehradun & Bangalore aim to provide advanced training in Electrical & UPS systems. These centers focus on enhancing students' skills and improving their job opportunities. Over 168 ITI students have been trained and over 10 have been placed as service engineers in our company.



Beach Clean-Up

Legrand adopted four beaches in Mumbai. This initiative aims to remove plastic waste and recycle it. Since September 2023, through the collective efforts of over 13992 volunteers, more than 134676 kg / 134.6 T of plastic has been collected and recycled into ten benches which were further donated to public spaces and schools.



Water Table Recharge

Legrand has recharged over 100 community borewells in rural and tribal areas using a patented technology that recharges 15–20 lakh litres of groundwater annually, directly providing clean water access to more than 5,000 individuals.



DRX™ MCCB

Type and frame size	Rated Current (A)	Poles	Cat.Nos	MRP* ₹ / Unit	Pack
---------------------	-------------------	-------	---------	---------------	------

DRX MCCBs

DRX 100 Icu = 10 kA	63 A	3 Pole	0270 39	4450	1/12
	75 A	3 Pole	0270 07	4450	1/12
	100A	3 Pole	0270 08	4450	1/12
	125A	3 Pole	0270 09	5840	1/12
	63 A	4 Pole	0270 29	6410	1/12
	75 A	4 Pole	0270 17	6410	1/12
	100A	4 Pole	0270 18	6410	1/12
	125A	4 Pole	0270 19	6890	1/12

Description	Cat.Nos	MRP* ₹ / Unit	Pack
-------------	---------	---------------	------

DIN Rail Adaptor

DRX 100	0271 87	610	1
---------	---------	-----	---

Rotary Handles - Direct

DRX 100	6687 70	1530	1
---------	---------	------	---

Rotary Handles - Vary-Depth

DRX 100	6687 71	2330	1
---------	---------	------	---

Padlocking Support for Operating Handle

DRX 100	0271 80	2080	1
---------	---------	------	---

Connection Accessories

Set of 2 shields for 3 pole	0271 81	150	1
-----------------------------	---------	-----	---

Sealable Terminal Shields (Moulded Shrouds)

For DRX 100 - 3 pole	0271 83	1990	1
For DRX 100 - 4 pole	0271 84	1860	1

Cage Terminals

For DRX 100 - 3 pole	0271 71	400	1
For DRX 100 - 4 pole	0271 73	380	1

Electrical Accessories

Block with 1 auxiliary (1 AUX)	0271 40	1330	1
Block with 1 auxiliary (1 AL)	0271 41	1330	1
Block with 1 auxiliary + 1 alarm (1 AUX + 1 AL)	0271 42	2320	1

Current Shunt Coils

200/277 V~ and =	0271 54	2880	1
380/480 V~ and =	0271 55	2880	1

Undervoltage Release Coils

200/240 V~	0271 64	3990	1
380/415 V~	0271 65	3990	1

DRX Spreader Links

3 Links set for TP	6250 10	330	1
4 Links set for FP	6250 11	480	1

* MRP - Maximum Retail Price Inclusive of all taxes including GST.



0270 08



0271 83



0271 40

DRX™ MCCB

Cat.Nos	Description	No. of modules	MRP* ₹ / Unit	Pack
---------	-------------	----------------	---------------	------

Metal One Way Enclosures for MCCB

5078 05	DRX 100 MCCB enclosure-TP	3	■	1
5078 06	DRX 100 MCCB enclosure-FP	3	3176	1

DRX100

The Universal Solution for Residential & Commercial



Robust Design

- Electrical life - 8000 operations
- Mechanical Life - 25000 operations
- Compliant with standard IES 60947-2

Complete range of Accessories available

- Direct and Extended Rotary Handles
- Shunt Release, UV Release in multiple voltage range
- Aux, Alarm, Aux + Alarm
- Cage Terminals for Direct Cable Termination
- Spreader Terminals for Enhanced Termination

Bold Cat.Nos are products normally available with Legrand (India) Stockists. Cat.Nos that are not bold - delivery within 4 - 8 weeks from the date of order. Bold packing quantity is our mandatory packing. Orders to be placed by Legrand (India) Stockist in multiples of the same.

DX³ MCBs

Cat.Nos	Nominal Rating	Number of 17.5 mm modules	MRP* ₹ / Unit	Pack
---------	----------------	---------------------------	---------------	------

MCBs for AC Applications till 63 A

10 kA ISI marked as per IS/IEC 60898-1 2002
Integrated label holder
Sliding bottom clamp
Efficient air channels
Color coded On/Off indication on dolly
Biconnect lower terminals
IP 20 protected terminals
Sliding shutters
Compatible with signal and control Auxiliaries

DC-80 V per pole - 1 kA

C Curve

Single Pole 240/410 V

4085 80	0.5	1	736	1/10/120
4085 81	1	1	736	1/10/120
4085 83	2	1	729	1/10/120
4085 84	3	1	729	1/10/120
4085 85	4	1	729	1/10/120
4085 87	6	1	449	1/10/120
4085 90	10	1	449	1/10/120
4085 92	16	1	449	1/10/120
4085 93	20	1	449	1/10/120
4085 94	25	1	449	1/10/120
4085 95	32	1	449	1/10/120
4085 96	40	1	1026	1/10/120
4085 97	50	1	1026	1/10/120
4085 98	63	1	1026	1/10/120

Single Pole + Neutral 240 V

4086 02	0.5	2	1925	1/5/60
4086 03	1	2	1925	1/5/60
4086 05	2	2	1925	1/5/60
4086 06	3	2	1925	1/5/60
4086 07	4	2	1925	1/5/60
4086 09	6	2	1362	1/5/60
4086 12	10	2	1362	1/5/60
4086 14	16	2	1362	1/5/60
4086 15	20	2	1362	1/5/60
4086 16	25	2	1362	1/5/60
4086 17	32	2	1362	1/5/60
4086 18	40	2	2203	1/5/60
4086 19	50	2	2203	1/5/60
4086 20	63	2	2203	1/5/60

Double Pole 415 V

4086 21	0.5	2	1999	1/40
4086 22	1	2	1999	1/40
4086 24	2	2	1999	1/40
4086 25	3	2	1999	1/40
4086 26	4	2	1999	1/40
4086 28	6	2	1472	1/40
4086 31	10	2	1472	1/40
4086 33	16	2	1472	1/40
4086 34	20	2	1472	1/40
4086 35	25	2	1472	1/40
4086 36	32	2	1472	1/40
4086 37	40	2	2316	1/40
4086 38	50	2	2316	1/40
4086 39	63	2	2316	1/40

Triple Pole 415 V

4086 43	0.5	3	2944	1/32
4086 44	1	3	2944	1/32
4086 46	2	3	2944	1/32
4086 47	3	3	2944	1/32
4086 48	4	3	2944	1/32
4086 50	6	3	2387	1/32
4086 53	10	3	2387	1/32
4086 55	16	3	2387	1/32
4086 56	20	3	2387	1/32
4086 57	25	3	2387	1/32
4086 58	32	3	2387	1/32
4086 59	40	3	3623	1/32
4086 60	50	3	3623	1/32
4086 61	63	3	3623	1/32

* MRP - Maximum Retail Price Inclusive of all taxes including GST.

DX³ MCBs

Cat.Nos	Nominal Rating	Number of 17.5 mm modules	MRP* ₹ / Unit	Pack
---------	----------------	---------------------------	---------------	------

Triple Pole + Neutral 415 V

4086 65	0.5	4	3735	1/32
4086 66	1	4	3735	1/32
4086 68	2	4	3735	1/32
4086 69	3	4	3735	1/32
4086 70	4	4	3735	1/32
4086 72	6	4	3112	1/32
4086 75	10	4	3112	1/32
4086 77	16	4	3112	1/32
4086 78	20	4	3112	1/32
4086 79	25	4	3112	1/32
4086 80	32	4	3112	1/32
4086 81	40	4	4451	1/32
4086 82	50	4	4451	1/32
4086 83	63	4	4451	1/32

Four Pole 415 V

4086 84	0.5	4	3687	1/32
4086 85	1	4	3687	1/32
4086 87	2	4	3687	1/32
4086 88	3	4	3687	1/32
4086 89	4	4	3687	1/32
4086 91	6	4	3243	1/32
4086 94	10	4	3243	1/32
4086 96	16	4	3243	1/32
4086 97	20	4	3243	1/32
4086 98	25	4	3243	1/32
4086 99	32	4	3243	1/32
4087 00	40	4	4614	1/32
4087 01	50	4	4614	1/32
4087 02	63	4	4614	1/32

DX³ isolators

Cat.Nos	Nominal Rating	Number of 17.5 mm modules	MRP* ₹ / Unit	Pack
---------	----------------	---------------------------	---------------	------

Isolators for AC Applications upto 125 A

ISI marked as per IEC 60947-3
Integrated label holder
Ergonomic red color dolly
Sliding bottom clamp
Double break mechanism
Improved air channels
Color coded On/Off indication on dolly
Biconnect lower terminals
IP 20 protected terminals
Compatible with signal and control Auxiliaries
Sliding shutters

Double Pole 240 V

4065 00	32	2	780	1/5/60
4065 01	40	2	858	1/5/60
4065 02	63	2	1134	1/5/60
4065 04	100	2	1557	1/5/60
4065 05	125	2	1771	1/5/60

Triple Pole 415 V

4065 09	32	3	1405	1/40
4065 10	40	3	1507	1/40
4065 11	63	3	1794	1/40
4065 13	100	3	1980	1/40
4065 14	125	3	2284	1/40

Four Pole 415 V

4065 18	32	4	1541	1/32
4065 19	40	4	1914	1/32
4065 20	63	4	2111	1/32
4065 22	100	4	2551	1/32
4065 23	125	4	2811	1/32

Bold Cat.Nos are products normally available with Legrand (India) Stockists. Cat.Nos that are not bold - delivery within 4 - 8 weeks from the date of order. Bold packing quantity is our mandatory packing. Orders to be placed by Legrand (India) Stockists in multiples of the same.



4085 90



4086 14



4086 37



4086 55



4086 77



4086 94



4065 00



4065 10



4065 20

DX³ RCBOs

Cat.Nos	Nominal Rating	Number of 17.5 mm modules	MRP* ₹ / Unit	Pack
---------	----------------	---------------------------	---------------	------

RCBOs Assembled for AC Applications upto 63 A

SI marked as per IS 12640-2
 Integrated label holder
 Ergonomic design
 Color coded On/Off indication on dolly
 Compatible with signal and control Auxiliaries
 Front face indication for earth leakage fault
 IP 20 protected terminals
 35 sq mm terminals
 Sliding shutters

Type -AC

Sensitive to residual alternating currents
 Use : standard applications

Double Pole 240 V, AC Type 30 mA

4113 22	6	4	5812	1/32
4113 23	10	4	5812	1/32
4113 24	16	4	5812	1/32
4113 25	25	4	5812	1/32
4113 26	32	4	6081	1/32
4113 27	40	4	6983	1/32
4113 28	63	4	8508	1/32

100 mA

4113 29	6	4	6991	1/32
4113 30	10	4	6991	1/32
4113 31	16	4	6991	1/32
4113 32	25	4	6991	1/32
4113 33	32	4	6991	1/32
4113 34	40	4	7926	1/32
4113 35	63	4	9147	1/32

300 mA

4113 36	16	4	7213	1/32
4113 37	25	4	7213	1/32
4113 38	32	4	7213	1/32
4113 39	40	4	8133	1/32
4113 40	63	4	9163	1/32

Four Pole 415 V, AC Type

30 mA

4113 65	16	7	7781	1/16
4113 66	25	7	7781	1/16
4113 67	32	7	7781	1/16
4113 68	40	7	8167	1/16
4113 69	63	7	9368	1/16

Four Pole 415 V, AC Type

100 mA

4113 70	16	7	8770	1/16
4113 71	25	7	8770	1/16
4113 72	32	7	8770	1/16
4113 73	40	7	9099	1/16
4113 74	63	7	10013	1/16

Four Pole 415 V, AC Type

300 mA

4113 75	16	7	9122	1/16
4113 76	25	7	9122	1/16
4113 77	32	7	9112	1/16
4113 78	40	7	9547	1/16
4113 79	63	7	10189	1/16

* MRP - Maximum Retail Price Inclusive of all taxes including GST.
 For terminating aluminium cables in MCBs / Isolators / RCCBs of rating 32 A and above, use of Entry Terminal Cat.No 6034_48 is mandatory.

RX³

When One is Not Good Enough, 10 Reasons to Switch to RX³

The RX³ range of MCBs, RCCBs, and Isolators is engineered for efficient, reliable, and safe circuit protection. Designed with low energy losses and high durability, it ensures consistent performance across residential installations.



RX³ MCBs

RX³ RCCBs

RX³ Isolators

Features

- Low watt loss design for improved energy efficiency
- High mechanical endurance up to 20,000 operations
- Supports cable sizes up to 35 mm² for flexible installation
- ISI marked and CE certified for quality assurance

Benefits

- Reduces energy consumption and operating costs
- Enables long service life of up to 13 years with high mechanical endurance
- Enhances installation flexibility while reducing risk of terminal damage
- Ensures safe and reliable performance with certified standards



Scan to know more about the product.

RX³ MCBs

Cat.Nos	Amps.	MRP* ₹ / Unit	Pack
---------	-------	------------------	------

ISI marked as per IS/IEC 60898-1 (2002)
 'B' characteristic MCBs with 10 kA breaking capacity
 Low watt loss
 35 sq. mm. cage terminals
 IP20 protected terminals
 Bi-connect lower terminals
 No line load bias
 Suitable for isolation

Single Pole

4024 31	6 A	311	1/10/120
4024 32	10 A	311	1/10/120
4024 33	16 A	311	1/10/120
4024 34	20 A	311	1/10/120
4024 35	25 A	311	1/10/120
4024 36	32 A	311	1/10/120
4024 37	40 A	684	1/10/120
4024 38	50 A	814	1/10/120
4024 39	63 A	814	1/10/120



4024 32

Double Pole

4024 40	6 A	1132	1/5/60
4024 41	10 A	1132	1/5/60
4024 42	16 A	1132	1/5/60
4024 43	20 A	1132	1/5/60
4024 44	25 A	1132	1/5/60
4024 45	32 A	1132	1/5/60
4024 46	40 A	1586	1/5/60
4024 47	50 A	1831	1/5/60
4024 48	63 A	1831	1/5/60



4024 48

Triple Pole

4024 49	6 A	1879	1/40
4024 50	10 A	1879	1/40
4024 51	16 A	1879	1/40
4024 52	20 A	1879	1/40
4024 53	25 A	1879	1/40
4024 54	32 A	1879	1/40
4024 55	40 A	2663	1/40
4024 56	50 A	2910	1/40
4024 57	63 A	2910	1/40



4024 57

Four Pole

4024 58	6 A	2531	1/32
4024 59	10 A	2531	1/32
4024 60	16 A	2531	1/32
4024 61	20 A	2531	1/32
4024 62	25 A	2531	1/32
4024 63	32 A	2531	1/32
4024 64	40 A	3078	1/32
4024 65	50 A	3506	1/32
4024 66	63 A	3506	1/32



4024 66

RX³ Isolators

Conforms to IS 13947-3 (IEC 60947-3)
 35 sq. mm cage terminals with safety shutters
 Bi-connect lower terminals

Double Pole

4020 08	40 A	764	1/5/60
4020 09	63 A	988	1/5/60
4020 10	80 A	1291	1/5/60



4020 08

Triple Pole

4020 14	40 A	1480	1/40
4020 15	63 A	1638	1/40
4020 16	80 A	2047	1/40



4020 14

Four Pole

4020 20	40 A	1747	1/32
4020 21	63 A	1857	1/32
4020 22	80 A	2330	1/32



4020 20

* MRP - Maximum Retail Price Inclusive of all taxes including GST.
 For terminating aluminium cables in MCBs / Isolators / RCCBs of rating 32 A and above, use of Entry Terminal Cat.No 6034 48 is mandatory.

RX³ RCCBs

Cat.Nos	Amps.	MRP* ₹ / Unit	Pack
---------	-------	------------------	------

As per IS 12640 - 2008
 Bi-connect lower terminal

Double Pole - Sensitivity 30 mA

4024 88	25 A	3845	1/5/60
4024 89	40 A	4339	1/5/60
4024 90	63 A	5277	1/5/60



4024 93

Double Pole - Sensitivity 100 mA

4024 92	25 A	4059	1/5/60
4024 93	40 A	4651	1/5/60
4024 94	63 A	5521	1/5/60

Four Pole - Sensitivity 30 mA

4025 19	25 A	4943	1/32
4025 20	40 A	5074	1/32
4025 21	63 A	5856	1/32



4025 25

Four Pole - Sensitivity 100 mA

4025 23	25 A	5263	1/32
4025 24	40 A	5390	1/32
4025 25	63 A	6279	1/32

RX³ Accessory

Cat.Nos	Description	MRP* ₹ / Unit	Pack
---------	-------------	------------------	------

Entry terminal

6034 48	50 mm ² Entry Terminal for RCCB	171	1
---------	--	-----	---



6034 48

'B' characteristic MCB tripping curve

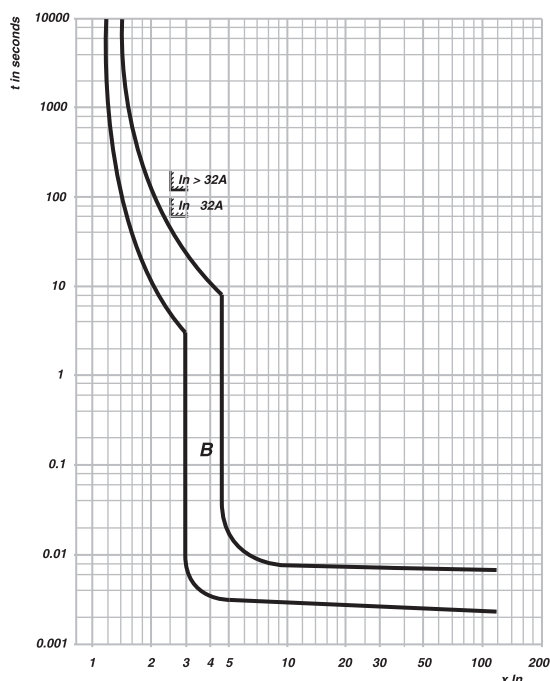

Bold Cat.Nos are products normally available with Legrand (India) Stockists.
 Cat.Nos that are not bold - delivery within 4 - 8 weeks from the date of order.
 Bold packing quantity is our mandatory packing. Orders to be placed by Legrand (India) Stockists in multiples of the same.

ACCL

Automatic Changeover with Current Limiter

Seamless Power Switching for Smart Electrical Systems



ACCL ensures uninterrupted power by automatically switching between mains and generator supply. Designed with intelligent control and built-in current limiting, it protects the generator from overload while maintaining reliable power continuity for residential and commercial installations.

Features

- Intelligent microcontroller-based design
- Built-in current limiter to prevent generator overload
- Break-before-make switching mechanism with neutral isolation
- LED status indicators with buzzer alerts and manual reset function

Benefits

- Ensures continuous power supply during mains failure
- Protects generator systems from overload damage
- Improves safety through controlled and reliable power transfer
- Simplifies monitoring with clear visual and audible status alerts

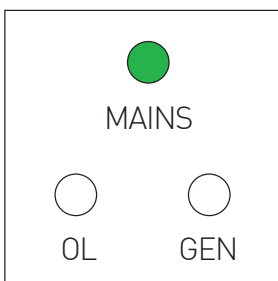

Mains ON

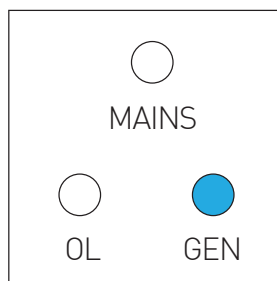

Genset ON

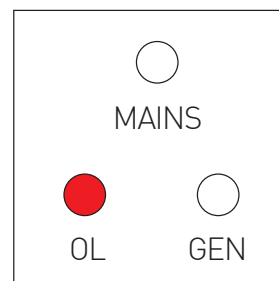

Overload



Scan to know more about the product.

Automatic Changeover with Current Limiter (ACCL)

Cat.Nos	Description	MRP* ₹ / Unit	Pack
---------	-------------	---------------------	------

Intelligent micro controller based design

Automatic source change over between Mains &

Generator supply

Break before make change over system

Buzzer and Led Indication of status

Current limitation prevents overloading of the generator

4053 00	SPN 30/3A	3220	1/15
4053 01	SPN 30/4A	3220	1/15
4053 02	SPN 30/5A	3220	1/15
4053 03	SPN 30/6A	3220	1/15
4053 04	SPN 30/9A	3220	1/15
4053 05	SPN 30/12A	3220	1/15
4053 06	SPN 30/15A	3220	1/15
4053 07	SPN 30/20A	3220	1/15
4053 08	SPN 30/30A	3220	1/15

* MRP - Maximum Retail Price Inclusive of all taxes including GST.

Bold Cat.Nos are products normally available with Legrand (India) Stockists. Cat.Nos that are not bold - delivery within 4 - 8 weeks from the date of order. Bold packing quantity is our mandatory packing. Orders to be placed by Legrand (India) Stockists in multiples of the same.

Ekinox

Reinvent The New

Safety Styled for
Modern Spaces



MAKE A **SECOND** GLANCE

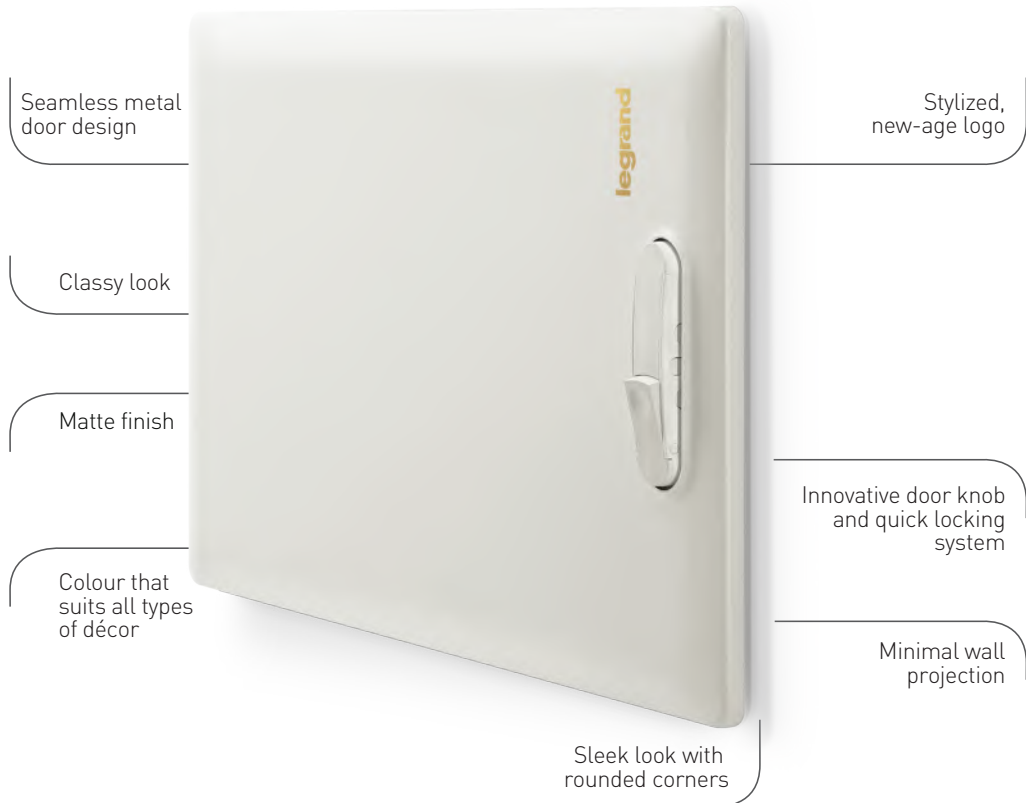

Scan to know more about the product.



Features and benefits

Maximum reliability & excellent safety-
Designed in accordance with IEC 61439-3



Integrated earthing system in order to avert risky contact



Completely insulated bus bars guarantee safety from severe shocks

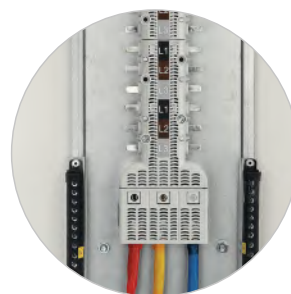

Shrouded neutral bars and insulated din rail for complete isolation



Reversible door can be easily removed



Normal lock convertible to key lock, so that it isn't tampered with



Colour-coded neutral bars for easy identification



Plastic plugs for mounting holes

Ekinox³ SPN DB's

For DX³ MCB, Isolator, RCCB and RCBO

Cat.Nos	Number of ways	No. of modules	MRP* ₹ / Unit	Pack
---------	----------------	----------------	------------------	------

- As per IEC 61439-3
- Suitable for Flush Mounting and Surface Mounting
- With 100 A Copper Busbar
- With Neutral bar, Earthbar and Cable ties for Cable management
- Fully shrouded Neutral bars
- Prefitted masking sheet
- Reversible Door for IP 43 & IP 54 DB's

IP 30 - *IK 08

5076 00	4 way	4	2128	1
5076 01	8 way	8	2581	1
5076 02	12 way	12	3050	1
5076 03	16 way	16	3726	1
5076 04	18 way	18	4334	1
5076 05	20 way	20	4434	1



5076 05



5076 12

IP 43 - *IK 09 with Metal Door

5076 10	4 way	4	2788	1
5076 11	8 way	8	3597	1
5076 12	12 way	12	4322	1
5076 13	16 way	16	5415	1
5076 14	18 way	18	5690	1
5076 15	20 way	20	6573	1

IP 43 - *IK 09 with Acrylic Door

5076 20	4 way	4	3726	1
5076 21	8 way	8	4316	1
5076 22	12 way	12	5245	1
5076 23	16 way	16	6514	1
5076 24	18 way	18	6815	1
5076 25	20 way	20	7216	1



5076 42

IP 54 - *IK 09

5076 40	4 way	4	9579	1
5076 41	8 way	8	11386	1
5076 42	12 way	12	13080	1
5076 43	16 way	16	14525	1
5076 44	18 way	18	14684	1
5076 45	20 way	20	15958	1

Ekinox³ ETPN DB's

For DX³ MCB, Isolator, RCCB and RCBO

- As per IEC 61439-3
- Suitable for Flush Mounting and Surface Mounting
- With 100 A Copper Busbar for each phase
- With Neutral bar, Earthbar and Cable ties for Cable management
- Fully insulated busbar & shrouded Neutral bars
- Improved Pan assembly for ease of installation
- Prefitted masking sheet
- Reversible Door for IP 43 & IP 54 DB's
- With provision for FP MCB/Isolator/RCCB/RCBO as incomer and SP MCB's as outgoing
- Supplied with wireset
- Can be converted to PPI DB at site using conversion kit

IP 30 - *IK 08

5076 60	4 way	8+12	6131	1
5076 61	6 way	8+18	7605	1
5076 62	8 way	8+24	8981	1
5076 63	12 way	8+36	12805	1
5076 64	16 way	8+48	15596	1
5076 66	20 way	8+60	21766	1



5077 01



5077 11

* MRP - Maximum Retail Price Inclusive of all taxes including GST.

Ekinox³ ETPN DB's

For DX³ MCB, Isolator, RCCB and RCBO

Cat.Nos	Number of ways	No. of modules	MRP* ₹ / Unit	Pack
---------	----------------	----------------	------------------	------

IP 43 - *IK 09 with metal door

5076 70	4 way	8+12	7335	1
5076 71	6 way	8+18	8841	1
5076 72	8 way	8+24	10593	1
5076 73	12 way	8+36	15709	1
5076 74	16 way	8+48	19664	1
5076 76	20 way	8+60	27398	1

IP 43 - *IK 09 with acrylic door

5076 80	4 way	8+12	9237	1
5076 81	6 way	8+18	11292	1
5076 82	8 way	8+24	13289	1
5076 83	12 way	8+36	20584	1
5076 84	16 way	8+48	24787	1
5076 86	20 way	8+60	33509	1

IP 54 - *IK 09

5076 90	4 way	8+12	22966	1
5076 91	6 way	8+18	27636	1
5076 92	8 way	8+24	30224	1
5076 93	12 way	8+36	43009	1
5076 94	16 way	8+48	51114	1
5076 96	20 way	8+60	60809	1

Ekinox³ Flexy DB

For DX³ DIN modular products

Cat.Nos	Number of row	No. of modules	MRP* ₹ / Unit	Pack
---------	---------------	----------------	------------------	------

- As per IEC 61439-3
- Suitable for Flush Mounting and Surface Mounting
- Completely flexible to organise the distribution as per site requirements
- Busbars to be selected as per distribution requirements
- With Neutral and Earth bars
- Fully shrouded Neutral bars
- Improved Pan assembly for ease of installation
- Prefitted masking sheet
- Reversible door for IP 43

IP 30 - *IK 08

5077 01	2 row of 14 M	28	7433	1
5077 02	3 row of 14 M	42	9304	1
5077 03	4 row of 14 M	56	10317	1

IP 43 - *IK 09 with metal door

5077 05	2 row of 14 M	28	9362	1
5077 06	3 row of 4 M	42	11191	1
5077 07	4 row of 14 M	56	12133	1
5077 14	4 row of 8 M	32	10351	1
5077 15	4 row of 10 M	40	10835	1
5077 12	3 row of 14 M MCCB for DPX ³ 160 MCCB	42	12881	1

IP 43 - *IK 09 with acrylic door

5077 09	2 row of 14 M	28	9874	1
5077 10	3 row of 14 M	42	12135	1
5077 11	4 row of 14 M	56	13749	1
5077 13	3 row of 14 M MCCB for DPX ³ 160 MCCB	42	14330	1

Bold Cat.Nos are products normally available with Legrand (India) Stockists. Cat.Nos that are not bold - delivery within 4 - 8 weeks from the date of order. Bold packing quantity is our mandatory packing. Orders to be placed by Legrand (India) Stockist in multiples of the same.

Ekinox³ TPN DB-VTPN DB's

For DX³ MCB, Isolator, RCCB and RCBO

Cat.Nos	Number of ways	No. of modules	MRP* ₹ / Unit	Pack
---------	----------------	----------------	------------------	------

- As per IEC 61439-3
- Suitable for Flush Mounting and Surface Mounting
- With 100 A Copper Busbar for each phase
- With 2 Neutral bar, 2 Earthbar and Cable ties for Cable management
- Fully insulated busbar & shrouded Neutral bars
- Improved Pan assembly for ease of installation
- Prefitted masking sheet
- Reversible Door for IP 43 & IP 54 DB's
- With provision for FP MCB/Isolator/RCCB/RCBO as incomer and SP/TP MCB's as outgoing

IP 30 - #IK 08

5077 20	4 way	8+12	16452	1
5077 21	6 way	8+18	18055	1
5077 22	8 way	8+24	20084	1
5077 23	12 way	8+36	28998	1

IP 43 - #IK 09 with metal door

5077 25	4 way	8+12	17350	1
5077 26	6 way	8+18	19215	1
5077 27	8 way	8+24	22365	1
5077 28	12 way	8+36	30090	1

IP 43 - #IK 09 with acrylic door

5077 30	4 way	8+12	22512	1
5077 31	6 way	8+18	24770	1
5077 32	8 way	8+24	28964	1
5077 33	12 way	8+36	38641	1

IP 54 - #IK 09

5077 35	4 way	8+12	36085	1
5077 36	6 way	8+18	39236	1
5077 37	8 way	8+24	43403	1
5077 38	12 way	8+36	56188	1

Ekinox³ TPN DB-VTPN

DPX³ 160 MCCB DB's

- As per IEC 61439-3
- Suitable for Flush Mounting and Surface Mounting
- With 250 A Copper Busbar for each phase
- With 2 Neutral bar, 2 Earthbar and Cable ties for Cable management
- Fully insulated busbar & shrouded Neutral bars
- Improved Pan assembly for ease of installation
- Prefitted masking sheet
- Reversible Door for IP 43 & IP 54 DB's
- With provision for DPX³ 160 MCCB as incomer and SP/TP MCB's as outgoing

IP 30 - #IK 08

5077 40	4 way	DPX ³ 160+12	18457	1
5077 41	6 way	DPX ³ 160+18	19741	1
5077 42	8 way	DPX ³ 160+24	21497	1
5077 43	12 way	DPX ³ 160+36	32562	1

IP 43 - #IK 09 with metal door

5077 45	4 way	DPX ³ 160+12	21185	1
5077 46	6 way	DPX ³ 160+18	24044	1
5077 47	8 way	DPX ³ 160+24	26489	1
5077 48	12 way	DPX ³ 160+36	36113	1

* MRP - Maximum Retail Price Inclusive of all taxes including GST.

Ekinox³ TPN DB-VTPN

DPX³ 160 MCCB DB's

Cat.Nos	Number of ways	No. of modules	MRP* ₹ / Unit	Pack
---------	----------------	----------------	------------------	------

IP 54 - #IK 09

5077 50	4 way	DPX ³ 160+12	42348	1
5077 51	6 way	DPX ³ 160+18	48219	1
5077 52	8 way	DPX ³ 160+24	52387	1
5077 53	12 way	DPX ³ 160+36	69016	1

Ekinox³ TPN DB-VTPN

DPX³ 250 MCCB DB's

- As per IEC 61439-3
- Suitable for Flush Mounting and Surface Mounting
- With 250 A Copper Busbar for each phase
- With 2 Neutral bar, 2 Earthbar and Cable ties for Cable management
- Fully insulated busbar & shrouded Neutral bars
- Improved Pan assembly for ease of installation
- Prefitted masking sheet
- Reversible Door for IP 43 & IP 54 DB's
- With provision for DPX³ 250 MCCB as incomer and SP/TP MCB's as outgoing

IP 30 - #IK 08

5077 55	4 way	DPX ³ 250+12	29552	1
5077 56	8 way	DPX ³ 250+24	31416	1
5077 57	12 way	DPX ³ 250+36	34675	1

IP 43 - #IK 09 with metal door

5077 58	4 way	DPX ³ 250+12	32495	1
5077 59	8 way	DPX ³ 250+24	34268	1
5077 60	12 way	DPX ³ 250+36	38723	1

IP 54 - #IK 09

5077 61	4 way	DPX ³ 250+12	49957	1
5077 62	8 way	DPX ³ 250+24	57090	1
5077 63	12 way	DPX ³ 250+36	66715	1

NEO DB

Phase Selector Neo DB

- As per IEC 61439-3
- Compact and sleek design
- IP 43 protection & IK 09
- Integrated LED indication in the selector switches
- With 100A copper busbar for each phase
- Fully insulated busbar & shrouded Neutral bars

5077 80N	4 way	8+12	19049	1
5077 81N	6 way	8+18	19357	1
5077 82N	8 way	8+24	20737	1
5077 83N	12 way	8+36	23354	1

Bold Cat.Nos are products normally available with Legrand (India) Stockists. Cat.Nos that are not bold - delivery within 4 - 8 weeks from the date of order. Bold packing quantity is our mandatory packing. Orders to be placed by Legrand (India) Stockist in multiples of the same.



5077 20



5077 31



5077 53



5077 55



5076 61



5077 81N

NEO DB

Cat.Nos	Description	MRP* ₹ / Unit	Pack
---------	-------------	---------------------	------

8 Segment Neo DB

IP 42 - #IK 09 with Metal Door

- As per IEC 61439-3
- DB with phase segmentation and separation between Incomer and Outgoings
- Sturdy & Robust design
- With 100A copper busbar for each phase
- Colour coded Neutral Bars
- Easy to Install : Detachable frame
- 8 compartments
- More number of knockouts
- IP42 & IK09
- Supplied with wire-set
- With provision for DPX³ 160 MCCB as incomer DP MCB/Isolator/RCCB/RCBO as sub incomers and SP MCB's as outgoing



5078 86N

5078 85N	4W 8/7S IP42 Neo	14681	1
5078 86N	6W 8/7S IP42 Neo	16447	1
5078 87N	8W 8/7S IP42 Neo	18423	1
5078 88N	12W 8/7S IP42 Neo	22936	1

IP 42- #IK09 suitable for 160A DPX³ MCCB as incomer

5078 95N	4W 8/7S 160A MCCB IP42 Neo	20380	1
5078 96N	6W 8/7S 160A MCCB IP42 Neo	23313	1
5078 97N	8W 8/7S 160A MCCB IP42 Neo	26942	1
5078 98N	12W 8/7S 160A MCCB IP42 Neo	30418	1

Ekinox³ Metal Enclosures

For DX³ MCB, RCCB, RCBO and DPX³ MCCB's

- As per IEC 61439-3
- Suitable for Flush Mounting and Surface Mounting
- Suitable for protection of appliances like AC/Geyser etc
- Supplied with Neutral Links
- With provision for mounting modular devices

#IK 08

5078 10	10 A SP, 2P+E	1	2771	1
5078 11	20 A SP, 2P+E	1	2985	1
5078 14	20 A DP, 2P+E	2	3243	1
5078 17	20 A TP, 3P+E	3	5494	1

* MRP - Maximum Retail Price Inclusive of all taxes including GST.



5078 14

Ekinox³ Metal Enclosures

Cat.Nos	Number of ways	No. of modules	MRP* ₹ / Unit	Pack
---------	----------------	----------------	---------------------	------

5078 18	32 A TP, 3P+E	3	6518	1
5078 20	20 A DP	4	3137	1
5078 21	RCBO, 2P+E	8	5485	1
5078 22	20 A FP	8	6466	1
	RCBO, 2P+E			
	32 A FP	8	6466	1
	RCBO, 3P+E			



5078 22



5078 60



5078 62



5078 64



5077 91



5077 93

Ekinox³ Metal Enclosures

For DX³ MCB, RCCB, RCBO and DPX³ MCCB's

- As per IEC 61439-3
- Suitable for Flush Mounting and Surface Mounting
- Supplied with Neutral Links
- With provision for mounting modular devices

#IK 08

5078 60	16 A 2P+E-DP	2	4525	1
5078 63	32 A 2P+E-DP	2	4891	1
5078 61	32 A 3P+E-FP	8	8188	1
5078 62	32 A	8	8283	1
	3P+N+E-FP			
5078 64	63 A	8	20618	1
	3P+N+E-FP			

- As per IEC 61439-3

- For independent mounting of DX³ MCB, RCCB, RCBO, DPX³ 160, DPX³ 250, DPX³ 630 & DRX MCCB's

- #IK 08

#IK 08

5077 90	SP enclosure	1	761	1
5077 91	DP enclosure	2	1097	1
5077 92	TP enclosure	3	1097	1
5077 93	FP enclosure	4	1097	1
5077 94	FP RCBO enclosure	8	1835	1

Metal One Way Enclosures for MCCB

5078 01	DPX ³ 160 MCCB enclosure	3&4	6242	1
5078 02	DPX ³ 250 MCCB enclosure	3&4	10976	1
5078 04	DPX ³ 630 MCCB enclosure	3&4	17050	1
5078 05	DRX 100 MCCB enclosure-TP	3	3370	1
5078 06	DRX 100 MCCB enclosure-FP	4	3176	1

Bold Cat.Nos are products normally available with Legrand (India) Stockists. Cat.Nos that are not bold - delivery within 4 - 8 weeks from the date of order. Bold packing quantity is our mandatory packing. Orders to be placed by Legrand (India) Stockist in multiples of the same.

Ekinox³ Metal Enclosures

Cat.Nos	Description	MRP* ₹ / Unit	Pack
---------	-------------	------------------	------

Ekinox³ Cable End Box

- Useful for keeping extra cables
- Possible to mount on the top or bottom of the DB
- Provision for mounting terminal blocks
- Can be used as a terminal box adaptor also

For IP 30 DB's

5079 10	For SPN 4 W IP30	1111	1
5079 12	For SPN 8 W IP30	1288	1
5079 14	For SPN 12 W/ VTPN/Flexy	1456	1
5079 16	For SPN 16 W/ ETPN 6 way DB	2045	1
5079 25	For ETPN 8 way DB	3673	1
5079 27	For ETPN 12 way DB	4850	1
5079 29	For ETPN 16 way DB	4850	1
5079 31	For ETPN 18 way DB	5021	1
5079 33	For ETPN 20 way DB	5198	1
5079 35	For ETPN 4 way VTPN/FLEXY MCB	1442	1
5079 37	For all VTPN MCCB DBS	5313	1

For IP 43 DB's

5079 11	For SPN 4 way DB	1272	1
5079 13	For SPN 8 way DB	1553	1
5079 15	For SPN 12 way/ VTPN/Flexy DB	1741	1

For IP 43 DB's

5079 17	For SPN 16 way/ ETPN 6 way DB	2473	1
5079 18	For SPN 18 way DB	2475	1
5079 19	For SPN 20/ETPN 8 way DB	2585	1
5079 28	For ETPN 12 way DB	5550	1
5079 30	For ETPN 16 way DB	5656	1
5079 32	For ETPN 18 way DB	5766	1
5079 34	For ETPN 20 way DB	6100	1
5079 36	For all ETPN 4W/VTPN/Flexy MCB	1741	1

* MRP - Maximum Retail Price Inclusive of all taxes including GST

▼ Compatible with Ekinox³ and NEO DB.

Ekinox³ Metal Enclosures

Cat.Nos	Description	MRP* ₹ / Unit	Pack
---------	-------------	------------------	------

For IP 43 DB's

5079 38	For all VTPN MCCB DBs	6182	1
5079 00▼	For 7 segment 4 way DB	5055	1
5079 01▼	For 7 segment 6 way DB	5548	1
5079 02▼	For 7 segment 8 way DB	6187	1
5079 03▼	For 7 segment 12 way DB	6994	1

Ekinox³ DBs

Meter Box

- Suitable for Mounting DX³ Metering products
- Possible to mount on the top or bottom of the DB
- Provision for mounting Ammeter/Voltmeter/ASS/VSS
- #IK09

Provision for Mounting Meters

5079 40	For VTPN MCB INCOM IP 30	6847	1
5079 41	For VTPN MCB INCOM IP 43	8402	1
5079 42	For VTPN MCCB INCOM IP 30	7615	1
5079 43	For VTPN MCCB INCOM IP 43	9697	1

Per Phase Isolation Kit

5079 44	PPI conversion kit for ETPN 4 way DB	4294	1
5079 45	PPI conversion kit for ETPN 6 way DB	4842	1
5079 46	PPI conversion kit for ETPN 8 way DB	5520	1
5079 47	PPI conversion kit for ETPN 12 way DB	6212	1
5079 48	PPI conversion kit for ETPN 16 way DB	6946	1

Panel Locks

5079 52	Panel knob for IP 43	474	1
5079 51	Panel knob with key	989	1

Bold Cat.Nos are products normally available with Legrand (India) Stockists. Cat.Nos that are not bold - delivery within 4 - 8 weeks from the date of order. Bold packing quantity is our mandatory packing. Orders to be placed by Legrand (India) Stockist in multiples of the same.

Plexo³ Boxes for DX³

Cat.Nos	Number of ways	MRP* ₹ / Unit	Pack
---------	----------------	------------------	------

Self-extinguishing: resistance to incandescent wire 650 °C

Conform to EN 60439-3

Weatherproof cabinets - IP 65 - IK 09 - Class II

Door and cabinet fully reversible

Removable chassis and faceplates from 2-row versions up

2-position rail for modular products and moulded cases

Spacing between rails 150 mm

Box colour light grey L750A, cover colour dark grey R746A

6019 32	2 (+1) Module	2581	1
6019 94	4 Module	2790	1
6019 96	6 Module	3186	1
6019 98	8 Module	3981	1



6019 94

Cabinets with 12 modules per row

6018 31	1 row 12 modules	6270	1
6018 32	2 rows 24 modules	8699	1
6018 33	3 rows 36 modules	12123	1



6018 32

* MRP - Maximum Retail Price Inclusive of all taxes including GST.

Plexo³ Boxes for DX³

Cat.Nos	Number ofWs	MRP* ₹ / Unit	Pack
---------	-------------	------------------	------

Cabinets with 18 modules per row

6018 35	18 modules x 1 row	7733	1
6018 36	18 modules x 2 rows	13381	1
6018 37	18 modules x 3 rows	18814	1
6018 38	18 modules x 4 rows	28159	1

Multifunction sleeves for P17

0019 17	For 2 row cabinets	4973	1
0019 18	For 3 row cabinets	7454	1
0019 67	Joining kit	1408	1



6018 32 + 0019 17

Bold Cat.Nos are products normally available with Legrand (India) Stockists. Cat.Nos that are not bold - delivery within 4 - 8 weeks from the date of order. Bold packing quantity is our mandatory packing. Orders to be placed by Legrand (India) Stockist in multiples of the same.

Plexo³ Boxes for DX³

Cat.Nos	Number ofWs	MRP* ₹ / Unit	Pack
Plexo-S			
6018 82	Waterproof cabinet 2M	2063	1
6018 84	Waterproof cabinet 4M	2429	1
6018 86	Waterproof cabinet 6M	2792	1
6018 88	Waterproof cabinet 8M	3436	1
6018 92	Waterproof cabinet 12M	5511	1
6018 94	Waterproof cabinet 24M	7590	1



6018 86



6018 94

Accessories

Fixing Lugs and Blanking Plates

0019 69	Set of 4 wall mounting lugs for Plexo, Plexo ³ cabinets and P17 combined units	■	1
0019 61	5, seperable into modules or 1/2 module Grey RAL 7046	■	20

* MRP - Maximum Retail Price Inclusive of all taxes including GST.

Accessories

Fixing Lugs and Blanking Plates

Cat.Nos	Number ofWs	MRP* ₹ / Unit	Pack
Direct Piercing End Caps			
0019 56	Pack consisting of 100 ø20 mm ISO and caps	■	1
0019 57	Pack consisting of 100 ø25 mm ISO and caps	■	1

Earth terminal and neutral terminal blocks

Brass Terminal Block with Isolated Support Conform to IEC 60998-2-1/2-2

1348 00	1 X (2x16 ² + 2x10 ²); ICC : 6kA	■	1
1348 01	1 X (3x16 ² + 3x10 ²); ICC : 6kA	■	1
1348 10	2 X (2x16 ² + 2x10 ²); ICC : 6kA	■	1
1348 11	2 X (3x16 ² + 3x10 ²); ICC : 6kA	■	1

Bold Cat.Nos are products normally available with Legrand (India) Stockists. Cat.Nos that are not bold - delivery within 4 - 8 weeks from the date of order. Bold packing quantity is our mandatory packing. Orders to be placed by Legrand (India) Stockist in multiples of the same.

PLEXO

Weatherproof Enclosures

The Go-To Range for Reliable Outdoor Installations

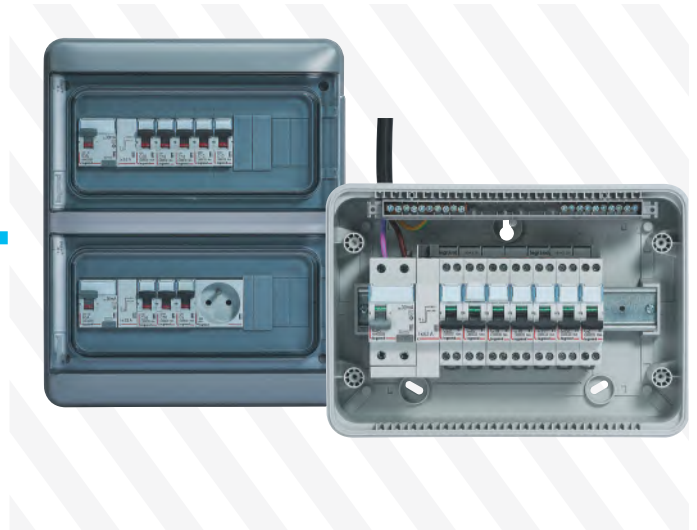

PLEXO enclosures deliver durable, weatherproof protection for modular electrical installations across indoor and outdoor environments. Featuring award-winning design, quick snap-fit assembly, and flexible configurations, they ensure faster installations and reliable performance in demanding site conditions.

Features

- Reversible modular design supporting 1–7 module configurations with transparent or opaque covers
- Tool-free snap-fit assembly for quick installation and flexible alignment
- High protection ratings with IP55–IP66 sealing and IK07–IK09 impact resistance
- Durable, eco-compliant materials with 650°C self-extinguishing capability

Benefits

- Reduces installation time with fast snap-fit mounting and flexible wiring space
- Performs reliably in harsh environments like garages, car parks, and wash areas
- Enables quick visual inspection using transparent protective covers
- Supports scalable installations with modular designs and smart-ready options



Scan to know more about the product.



Ekinox³

For converting ETPN DB to PPI DB

PPI DB IP 30 - IK 08

No. of ways	Combine		No. of modules
	ETPN DB	PPI Kit	
4 way	4 way 507660	4 way kit 507944	8+12
6 way	6 way 507661	6 way kit 507945	8+18
8 way	8 way 507662	8 way kit 507946	8+24
12 way	12 way 507663	12 way kit 507947	8+36
16 way	16 way 507664	16 way kit 507948	8+48

PPI DB IP 43 - IK 09 with metal door

No. of ways	Combine		No. of modules
	ETPN DB	PPI Kit	
4 way	4 way 507670	4 way kit 507944	8+12
6 way	6 way 507671	6 way kit 507945	8+18
8 way	8 way 507672	8 way kit 507946	8+24
12 way	12 way 507673	12 way kit 507947	8+36
16 way	16 way 507674	16 way kit 507948	8+48

PPI DB IP 43 - IK 09 with acrylic door

No. of ways	Combine		No. of modules
	ETPN DB	PPI Kit	
4 way	4 way 507680	4 way kit 507944	8+12
6 way	6 way 507681	6 way kit 507945	8+18
8 way	8 way 507682	8 way kit 507946	8+24
12 way	12 way 507683	12 way kit 507947	8+36
16 way	16 way 507684	16 way kit 507948	8+48

PPI DB IP 54 - IK 09

No. of ways	Combine		No. of modules
	ETPN DB	PPI Kit	
4 way	4 way 507690	4 way kit 507944	8+12
6 way	6 way 507691	6 way kit 507945	8+18
8 way	8 way 507692	8 way kit 507946	8+24
12 way	12 way 507693	12 way kit 507947	8+36
16 way	16 way 507694	16 way kit 507948	8+48

IK

Protection against mechanical impact: protection index - IK

According to standard:

IEC 62262, BS EN 62262 and NF EN 62262

• This table can be used to ascertain the resistance of a product to an impact given in Joules from the IK code (graduated from 00 to 10)

It can also be used to ascertain the correspondence with the old IP code 3rd digit and the corresponding external "Ag" conditions

IK	Tests	Impact energy (in Joules)	"AG" of NF C 15-100
IK 00		0	
IK 01		0.15	
IK 02		0.2	AG1
IK 03		0.35	
IK 04		0.5	
IK 05		0.7	
IK 06		1	
IK 07		2	AG2
IK 08		5	AG3
IK 09		10	
IK 10		20	AG4

IPXX

Index of protection

IP*** index of protection of enclosures of electrical equipment in accordance with standards IEC 529, BS 5490, DIN 400 50 and NF C 20-010

Up to 1000 V± and 1500 V= (standard UTE C 20 010)

1st figure:- protection against solid bodies

IP	tests	
0		No protection
1		Protected against solid bodies larger than 50 mm (eg:- accidental contact with the hand)
2		Protected against solid bodies larger than 12 mm (eg:- finger)
3		Protected against solid bodies larger than 2.5 mm (eg:- tools, wires)
4		Protected against solid bodies larger than 1 mm (eg:- fine tools and small wires)
5		Protected against dust (no harmful deposit)
6		Completely protected against dust

2nd figure:- protection against liquids

IP	tests	
0		No protection
1		Protected against vertically-falling drops of water (condensation)
2		Protected against drops of water falling at up to 15° from the vertical
3		Protected against drops of rain water at up to 60° from the vertical
4		Protected against projections of water from all directions
5		Protected against jets of water from all directions
6		Protected against jets of water of similar force to heavy seas
7		Protected against the effects of immersion
8		Protected against prolonged effects of immersion under pressure

The contents of all the above charts are for guidance only, if you have any doubt as to the interpretation of the information contained therein, please refer either to the standard itself or contact Legrand.

In accordance with our policy of continuous improvement, Legrand reserves the right to change specifications and designs without notice. All information given here is correct at the time of going to press.

Dizly

SEAMLESS DEZIRE

Don't hide,
Flaunt it!



Stylish Distribution Boards for every interior.

Dizly range enhances any space with its stylish design while ensuring safety. The metal finish adds a touch of class that's sure to impress every time.

Benefits

- Enhances interiors with a seamless and modern look
- Simplifies installation and wiring with user-friendly design
- Ensures reliable and safe performance
- Delivers long-term durability with robust build quality

Scan to know more about
the product.



Product Features

Suitable for Flush Mounting and Surface Mounting
Mounting key holes are provided in every Dizly DB, as an option for surface mounting

Ease of Wiring
Adequate wiring space is provided

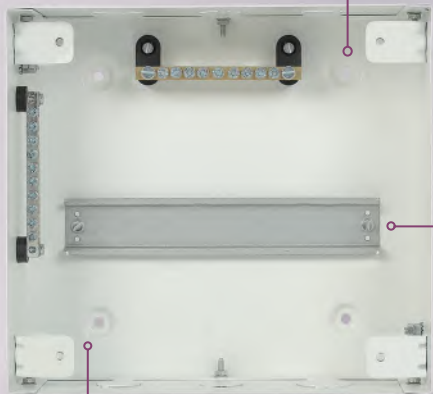

Ensuring Reliability and Safety
Designed as per Indian & Internationally accepted Standard

Sturdy & Robust
Manufactured with high precision and high quality CRCA steel sheets

Striking Design
Superior design & finish that blends seamlessly with all kinds of interior decor.

Colour
Pristine white in colour with matt finishing



An Unmatched Innovation
Knobless Opening & Closing of door

Dizly Distribution Board

Cat.Nos	Description	MRP* ₹ / Unit	Number of Modules
---------	-------------	------------------	-------------------

SPN IP 20 Single Door

4023 60	SPN 6W IP20 DB	1418	6
4023 61	SPN 8W IP20 DB	1497	8
4023 62	SPN 10W IP20 DB	1735	10
4023 63	SPN 12W IP20 DB	2252	12
4023 64	SPN 14W IP20 DB	2442	14



4023 61

SPN IP 42 Double Door

4023 65	SPN 6W IP42 DB	2424	6
4023 66	SPN 8W IP42 DB	2717	8
4023 67	SPN 10W IP42 DB	3122	10
4023 68	SPN 12W IP42 DB	3276	12
4023 69	SPN 14W IP42 DB	3622	14
4023 80	SPN 16W IP42 DB	4559	16



4023 66

TPN IP 20 Single Door

4023 70	ETPN 4W IP20 DB	4031	4+12
4023 71	ETPN 6W IP20 DB	4852	4+18
4023 72	ETPN 8W IP20 DB	6446	8+24
4023 73	ETPN 12W IP20 DB	6934	8+36



4023 71

TPN IP 42 Double Door

4023 74	ETPN 4W IP42 DB	5203	4+12
4023 78	ETPN 4W 8M IP42 DB	6209	8+12
4023 75	ETPN 6W IP42 DB	6444	4+18
4023 79	ETPN 6W 8M IP42 DB	7320	8+18
4023 76	ETPN 8W IP42 DB	8351	8+24
4023 77	ETPN 12W IP42 DB	12133	8+36



4023 75

* MRP - Maximum Retail Price Inclusive of all taxes including GST.

ARTEOR™ ADVANCE

FEEL SOMETHING NEW

Premium Wiring Devices for Fine Living



Arteor™ Advance is a premium wiring device range designed for luxury residences, offices, and hospitality spaces. It combines refined aesthetics, innovative mechanisms, and smart connectivity to deliver elegant functionality for modern interiors.

Features

- Dual rocker styles with Classic and Elite designs
- Premium finish collections including Matt, Decor, Metal, and Statement full-metal plates
- Integrated plate adjuster for precise alignment on uneven walls
- Smart-ready features such as contactless switches, motion sensors, and hotel keycard controls

Benefits

- Elevates interior design with premium finishes and modern styling
- Supports connected living with integrated charging and smart control options
- Provides versatile solutions for residential, office, and hospitality spaces
- Ensures long-lasting performance with durable aluminium plates and refined build quality



Celebrating Design That Elevates Every Space



Scan to know more about
the product.



ARTEOR™ ADVANCE

FEEL SOMETHING NEW

Two Forms, One Design Concept



CLASSIC



ELITE

Design language

Arteor Advance is available in two design lines, with clearly different rocker formats. The Classic design gives a whole new dimension to a classic form. The Elite rocker is a completely new design embodying the trends of the future.

Floating rocker

The impression created by the floating rocker is the same for both types: Light and elegant, it seems to float above the plate. Both forms can be combined to great effect as well. The Elite version allows you to make a clear statement, while the Classic version is more subtle and discreet.

Statement Collection
FULL METAL



Decor Collection
FROSTED FINISHES



Classic Collection
BASIC NEUTRAL



Decor Collection
METAL FINISHES



ARTEOR™ ADVANCE

FEEL SOMETHING NEW

Modular Design for Maximum Flexibility

The modular architecture of the range allows to integrate a wide range of different functions within a single plate, whatever the installation standard.



Even where space is scarce, individual configurations are possible.



Full modularity for maximum flexibility.

One Plate, Two Designs – Perfect Integration

Modularity is also maintained when you want to use both ergonomics, Classic and Elite in one plate. Thanks to special hybrid plates, both design lines can be combined in one plate at the same time, for more creative possibilities with a harmonious look.

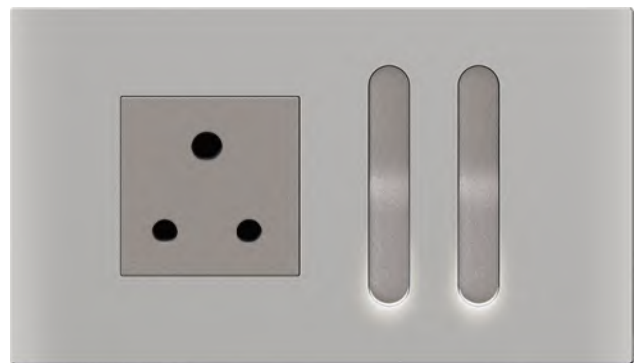

Switches in Elite design are easy to combine with socket outlets, dimmers, or USB chargers. Maximum flexibility for a wealth of combinations and a perfect look even when space is limited.

Pioneering a Sustainable Future with Bio-plastic Innovation

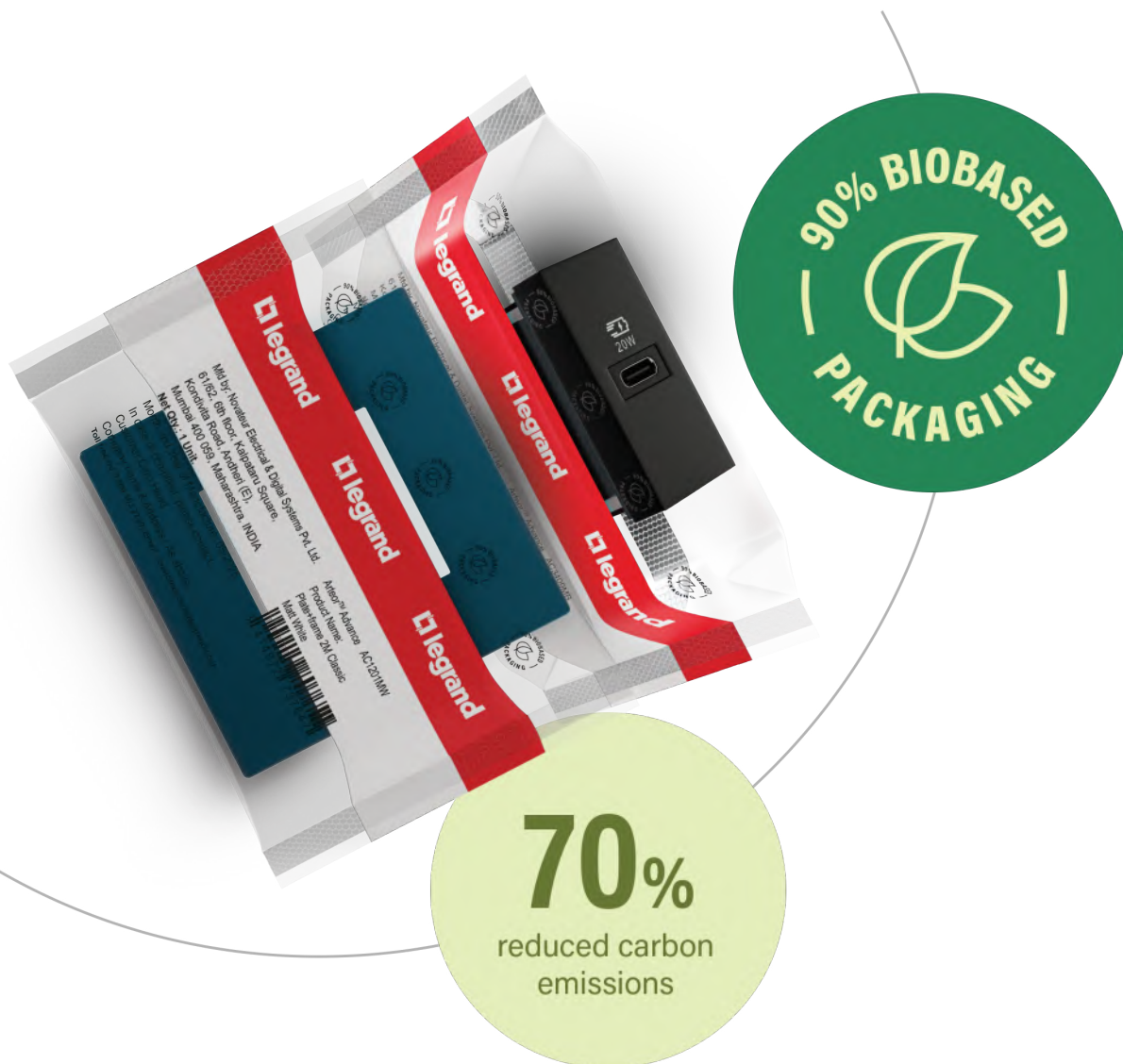

Innovation at Legrand goes beyond the product. Arteor Advance is our first range to feature packaging made with an innovative bio-plastic material. This pioneering eco-packaging solution is 90% biobased and is designed to lower carbon emissions by up to 70%. A conscious step towards a greener product lifecycle and a better future.

ARTEOR™ ADVANCE

FEEL SOMETHING NEW

Live As You Want

Everyone has their own ideas about how to arrange their living space, and people's individual preferences regarding the functionality of electrical equipment will vary widely too. With Arteor Advance, everyone can arrange their own private space accordingly and accommodate as much comfort or energy saving as they want. All in a premium consistent design.





Exploiting Every Potential

The new generation of LED dimmers and LED automatic switches are fully LED compatible and can also be used for all other types of modern loads. This makes it possible to exploit the full energy saving potential of LEDs, without losing out on convenience.



Switch with indicator



Smart 2-gang wireless batteryless light switch



Rotary fan controller



Double switch for electric shutter



USB Type C+C 30W PD Charger

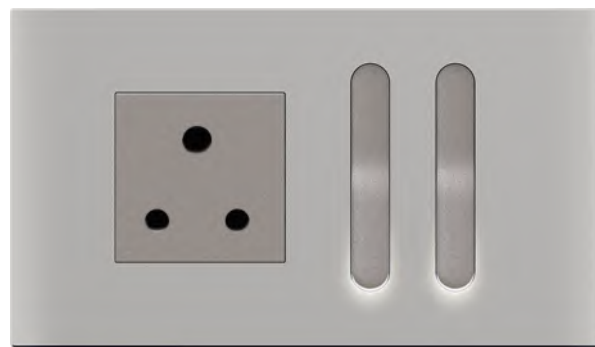

6A - 3 pin ISI Socket with 10A Elite Switch with Locator



TV-R-SAT sockets

Intelligent & Powerful: The New Usb Chargers

Arteor Advance meets the current USB-C standard with new chargers that integrate harmoniously into the design of the rest of the electrical installation. In addition to their design, they also impress with their performance; they are powerful enough to charge laptops. They also enable "fast charging" and protect the batteries of the connected devices with Power Delivery as they supply as much power as is needed for charging. Available in 20W, 30W, 45W and 65W.

ARTEOR™ ADVANCE

FEEL SOMETHING NEW

Working with Arteor™ Advance

The boundaries between life and work are becoming increasingly blurred. That's why Arteor Advance offers solutions that make life and work both easier and more comfortable, while making optimal use of the possibilities offered by connectivity. The understated design improves both quality of life and productivity.

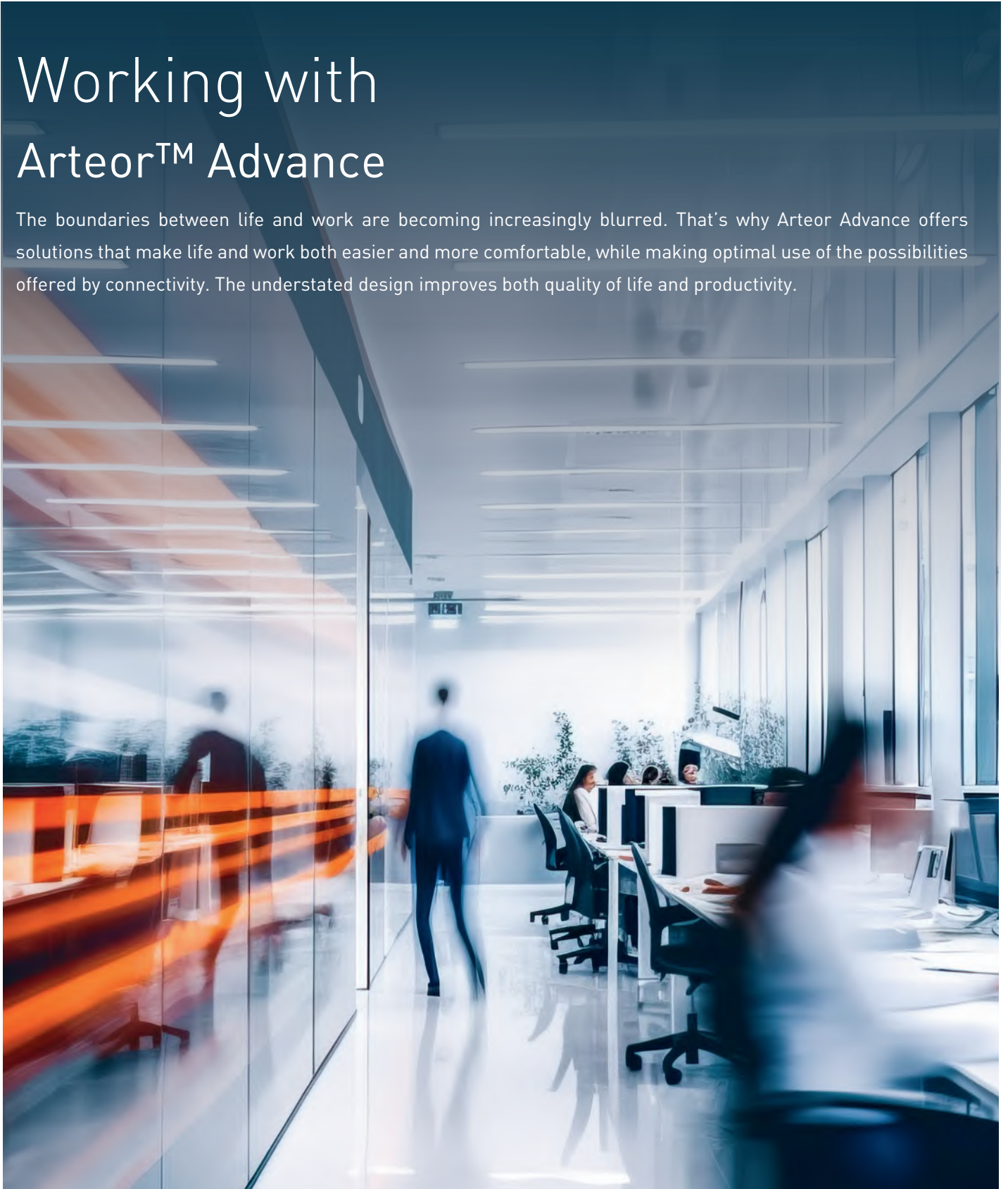



Arteor Advance mechanisms can be incorporated into Pop-Up boxes or Desk devices of the Incara range: seamless integration into furniture - power and data within easy reach.



All-in-one consistent design:

Power supply for all devices, data outlets and USB chargers with enough power for charging a laptop.



LED compatible motion sensors help to save energy as they only switch lights on when needed.

Contactless Switching

A new switch offers a more hygienic way of using lights and doors. It controls lights or opens doors without direct contact. Just position your hand close by, and the desired action will be triggered. In offices, hotels and anywhere lots of people use switches, the contactless switch is a valuable and convenient alternative to traditional solutions.

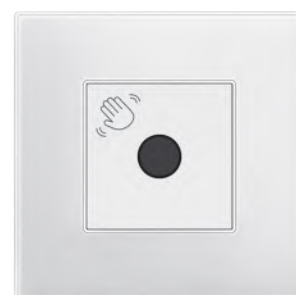

ARTEOR™ ADVANCE

FEEL SOMETHING NEW

Welcome to the
Arteor™ Advance Hotel

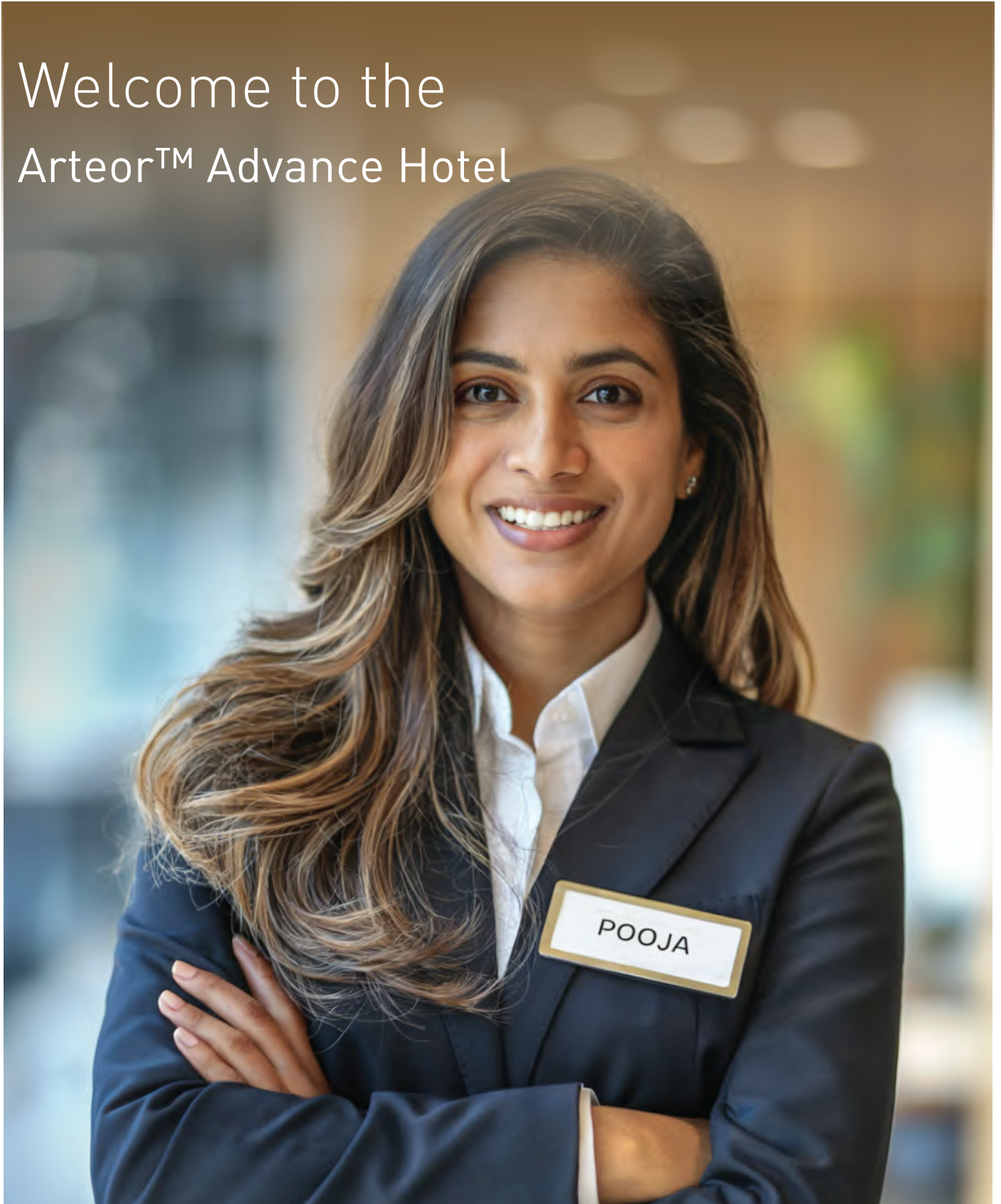



Key-Card Switch



Hotel room call indicator
External unit: displays calls in the corridor.

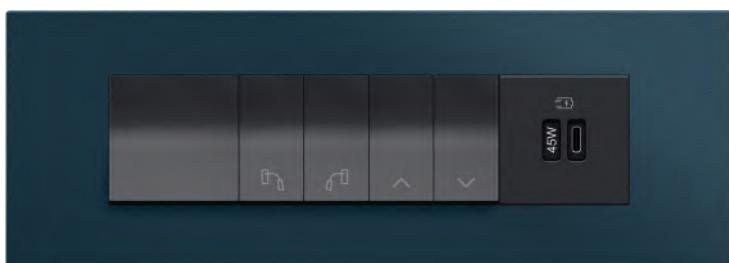

Bedside panel: Dedicated markings allow for easy identification of the different functions: Master ON/OFF, control of bedlights, curtains, roller blinds, and more.



Internal unit: allows to select the desired setting "Do not disturb/Make up room".

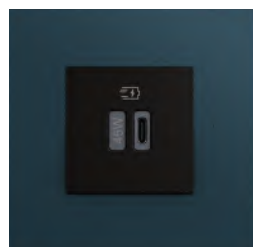

USB Type C 45W PD Charger



Double USB Type-C charger, 65 W, Fast charge feature: Power Delivery



Shaver Socket

Lots of power with gentle fast charging

USB chargers are an essential feature, and not just for mobile working. They provide enough energy to charge laptops and other devices. The batteries are charged in a particularly resource-efficient manner by intelligently adjusting the charging current to the needs of the devices connected.

Arteor Advance™

NEW! Classic Matt White Mechanisms

Cat.Nos	Description	MRP* ₹ / Unit	Pack
Switches – 10A - 230V AC			
AC21104MW	10A - Switch - 1 Way - 1 Module	264	1/20/200
AC21106MW	10A - Switch - 1 Way - with Indicator - 1 Module	488	1/20/200
AC21105MW	10A - Switch - 1 Way - with Locator - 1 Module	488	1/20/200
AC21102MW	10A - Switch - 1 Way - with Locator (Blue) - 1 Module	488	1/20/200
AC22105MW	10A - Switch - 2 Way - 1 Module	432	1/20/200
AC22107MW	10A - Switch - 2 Way - with Indicator - 1 Module	608	1/20/200
AC21119MW	10A - Switch - 1 Way - with Indicator - 2 Module	590	1/10/100

Switches – 16A - 230V AC

AC21101MW	16A - Switch - 1 Way - 1 Module	442	1/20/200
AC21118MW	16A - Switch - 1 Way - with Indicator - 1 Module	562	1/20/200
AC22101MW	16A - Switch - 2 Way - 1 Module	690	1/20/200
AC22102MW	16A - Switch - 2 Way - with Indicator - 1 Module	700	1/20/200
AC21103MW	16A - Switch - 1 Way - 2 Module	590	1/10/100
AC20109MW	16A - Intermediate Switch - 230V AC - 2 Module	3444	1/10/100
AC22109MW	16A - Switch - 2 Way - 2 Module	970	1/10/100

Switches – 20A - 230V AC

AC21107MW	20A - Switch - 1 Way - 1 Module	586	1/20/200
AC21108MW	20A - Switch - 1 Way - with Indicator - 1 Module	664	1/20/200
AC22106MW	20A - Switch - 2 Way - 1 Module	760	1/20/200
AC22108MW	20A - Switch - 2 Way - with Indicator - 1 Module	846	1/20/200
AC21112MW	20A - Switch - 1 Way - 2 Module	698	1/10/100
AC22119MW	20A - Switch - 2 Way - 2 Module	828	1/10/100

* MRP - Maximum Retail Price Inclusive of all taxes including GST.
Red Cat. Nos - New Products

Arteor Advance™

NEW! Classic Matt White Mechanisms

Cat.Nos	Description	MRP* ₹ / Unit	Pack
Switches – 20A - 230V AC			
AC22113MW	20A - Switch - 2 Way - with Indicator - 2 Module	918	1/10/100
AC21312MW	20A - Switch - 3 Gang - 1 Way - 2 Module	1652	1/10/100
AC29101MW	20A - Switch - 3 Gang - 2X2 Way + 1X1 Way - 2 Module	1810	1/10/100
AC21113MW	20A - Switch - DP - 1 Way - with Indicator - 2 Module	1302	1/10/100
AC20105MW	20A - Switch - DP - 1 Way - with Indicator & Water Heater Marking - 2 Module	1364	1/10/100

Switches – 25A - 230V AC

AC21115MW	25A - Switch - 1 Way - with Indicator - 1 Module	786	1/20/200
------------------	--	-----	----------

Switches – 32A - 230V AC

AC20101MW	32A - Switch - DP - 1 Way - with Indicator - 2 Module	1858	1/10/100
------------------	---	------	----------

Push Button – 10A - 230V AC

AC23102MW	10A - Bell Push - 1 Way - 1 Module	484	1/20/200
AC23103MW	10A - Bell Push - 1 Way - with Locator - 1 Module	642	1/20/200
AC23104MW	10A - Bell Push - 1 Way - with Locator (Blue) - 1 Module	642	1/20/200
AC23111MW	10A - Bell Push - 1 Way - 2 Module	682	1/10/100
AC23112MW	10A - Bell Push - 1 Way - with Locator - 2 Module	914	1/10/100
AC23121MW	10A - Bell Push - 1 Way - with Locator (Blue) - 2 Module	914	1/10/100
AC23106MW	10A - Push Button - 1 Way - 1 Module	512	1/20/200
AC23107MW	10A - Push Button - 1 Way - with Locator - 1 Module	648	1/20/200
AC23120MW	10A - Push Button - 1 Way - with Locator (Blue) - 1 Module	648	1/20/200
AC23108MW	10A - Push Button - 2 Way - 1 Module	714	1/10/100

Bold Cat.Nos are products normally available with Legrand (India) Stockists. Cat.Nos that are not bold - delivery within 4 - 8 weeks from the date of order. Bold packing quantity is our mandatory packing. Orders to be placed by Legrand (India) Stockist in multiples of the same.

Arteor Advance™

NEW! Classic Matt White Mechanisms

Cat.Nos	Description	MRP* ₹ / Unit	Pack
---------	-------------	------------------	------

Accessories for Classic and Elite Switches with Locator and Indicator

A180	Red LED for Indicator 230 V	108	10/100
A186	Blue LED for Locator 230 V	108	10/100
A187	Warm white LED for Locator 230 V 0.8	108	10/100
A188	Warm white LED for Locator 230 V 0.3	108	10/100



Electric Roller Blinds

AC26104MW	Double Switch for Electric Shutter - 2 Module	1184	1/10/100
------------------	---	------	----------

Dimmers and Fan Regulators

AC24103MW	Light Dimmer - 60 to 400 Watts - 2 Module	1996	1/10/100
AC24105MW	Push Dimmer 0-10V - 2 Module	12810	1/20
AC24101MW	Push Dimmer 150W With Neutral - 1 Module	18302	1/5/20
AC24104MW	Push Dimmer 125W Without Neutral - 2 Module	11896	1/20
AC24106MW	Touch Dimmer 5-300W/75W - 2 Module	10980	1/20
AC24107MW	Rotary Dimmer 200W LED - 2 Module	20132	1/10
AC661MW	Fan Step Regulator - 100 Watts - ISI - 1 Module	1604	1/5/50
AC662MW	Fan Step Regulator - 100 Watts - ISI - 2 Module	1980	1/10/100
AC665MW	Fan Step Regulator - 70 Watts - ISI - 2 Module	2110	1/10/100
AC663MW	Fan Step Regulator - 120 Watts - ISI - 2 Module	2118	1/10/100
AC664MW	Fan Regulator - 8 Steps - 100 Watts - ISI - 2 Module	1886	1/10/100



AC664MW

* MRP - Maximum Retail Price Inclusive of all taxes including GST.
Red Cat. Nos - New Products

Arteor Advance™

NEW! Classic Matt White Mechanisms

Cat.Nos	Description	MRP* ₹ / Unit	Pack
---------	-------------	------------------	------

Indian Standard Sockets

AC3163MW	6A - Socket - with Shutter - 3 Pin - ISI - 2 Module	404	1/20/200
AC3166MW	6/16A - Socket - with Shutter - 3 Pin - Indian - ISI - 2 Module	818	1/10/100
AC3167MW	6/16A - Socket - with Shutter - 3 Pin - Indian - ISI - 3 Module	980	1/5/50



AC100MW

Energy Plugs

AC100MW	6A - Plug	192	10/100
AC101MW	16A - Plug	256	10/100

USB Chargers

AC3408MW	USB Charger - 3000mA/15 Watts - Type A - 1 Module	3668	1/10/150
AC3410MW	USB Charger - 3000mA/15 Watts - Type A + A - 1 Module	4150	1/10/150
AC3411MW	USB Charger - 3000mA/15 Watts - Type A + C - 1 Module	4626	1/10/150
AC3412MW	USB Charger - 3000mA/15 Watts - Type C + C - 1 Module	5178	1/10/150
AC3409MW	USB Charger - Power Delivery - 20 Watts - Type C - 1 Module	7090	1/10/150
AC3406MW	USB Charger - Power Delivery - 30 Watts - Type C + C - 2 Module	10610	1/20
AC3401MW	USB Charger - Power Delivery - 45 Watts - Type C - 2 Module	13690	1/20
AC3415MW	USB Charger - Power Delivery - 65 Watts - Type C + C - 3 Module	16766	1/20



AC3401MW

Data and Voice

AC423MW	Telephone Socket - Double RJ11 - 1 Module	746	1/20/200
AC424MW	Telephone Socket - RJ11 - with Shutter - 1 Module	434	1/20/200
AC4306MW	Information Socket - RJ45 - Cat 6A - UTP - 1 Module	1946	10/100
AC4315MW	Information Socket - RJ45 Rear Pluggable - CAT6 - UTP - 2 Module	5356	1/10/100



AC4306MW



AC4110MW

TV Sockets

AC4110MW	TV Co - axial Socket - 1 Module	446	1/20/200
-----------------	---------------------------------	-----	----------

Bold Cat.Nos are products normally available with Legrand (India) Stockists. Cat.Nos that are not bold - delivery within 4 - 8 weeks from the date of order. Bold packing quantity is our mandatory packing. Orders to be placed by Legrand (India) Stockist in multiples of the same.

Arteor Advance™

NEW! Classic Matt White Mechanisms

Cat.Nos	Description	MRP* ₹ / Unit	Pack
---------	-------------	------------------	------



AC618MW

Electronic Chime

AC618MW	Bell Ding Dong - 230V - 2 Module	800	1/10/100
----------------	----------------------------------	-----	----------

Buzzer

AC615MW	Buzzer - 230V - 1 Module	2114	10/60
----------------	--------------------------	------	-------

Bell Call Indicator



AC23105MW

AC23105MW	Bell Call Indicator - 1 Module	3070	1/20/200
------------------	--------------------------------	------	----------

Infrared Sensors



AC25102MW

AC25102MW	IR Motion Sensor with Neutral - 2 Module	12920	1/20
------------------	--	-------	------

Innovative Switch



AC28102MW

AC28102MW	Contactless Door Switch - 12-24-48 V - 2 Module	7466	1/20
------------------	---	------	------

AC28101MW	Contactless Light Switch - 230V AC - 2 Module	6718	1/20
------------------	---	------	------

Skirting Light



AC653MW

AC653MW	Skirting Light - with LED - 230V - 3 Module	1648	10/100
----------------	---	------	--------

AC652	Removable Plug-in Skirting Light - 230V - 2 Module	25012	1/12
--------------	--	-------	------

Lighting



AC654

AC654	Over Door Light Unit White/Red/Green/Blue - 2 Module	762	1/50
--------------	--	-----	------

AC655	Indicator Unit - with transparent & Colored Labels- 1 Module	1234	10/100
--------------	--	------	--------

AC656	Illuminated Light unit with 4 LED colours (white/red/green/blue) - 2 Module	1360	5/50
--------------	---	------	------

Hospitality Function

Hotel "DND and MMR" functions



AC27107MW

AC27107MW	Interlocked Internal DND & MMR Control Unit - 2 Module	2364	1/10/100
------------------	--	------	----------

AC27108MW	External DND & MMR Control Unit - with Bell Push - 2 Module	3298	1/5/50
------------------	---	------	--------

Hotel Keycard Switch



AC27110MW

AC27110MW	16A - Key Card Switch - 230V - 2 Module	9000	1/20
------------------	---	------	------

AC27111MW	16A - Key Card Switch with RFID - 230V - 2 Module	9388	1/20
------------------	---	------	------

679255	Key Fob for Key Card Switch White	234	-
---------------	-----------------------------------	-----	---

Arteor Advance™

NEW! Hospitality Funtion

Cat.Nos	Description	MRP* ₹ / Unit	Pack
---------	-------------	------------------	------

Hotel Keycard Switch

076711	Key Fob for RFID Key Card Switch	2698	10/200
---------------	----------------------------------	------	--------

Shaver Socket



AC361MW

AC361MW	Shaver Socket - 230V/120 - 230V - with Earth Connector	9354	1/10
----------------	--	------	------

Time Switch

AC20110MW	Time Delay Switch - 2 Module	11044	1/20
------------------	------------------------------	-------	------

Master Switch



AC22114MW

AC22114MW	20A - Master Switch - DP - 2 Way - ON/OFF - 2 Module	812	1/10/100
------------------	--	-----	----------

AC23115MW	Master Push ON/OFF - 2 Way - 2 Module	794	1/10/100
------------------	---------------------------------------	-----	----------

Bedlight Switch

AC21117MW	10A - Bedlight Switch - 2 Way - 2X1 - 2 Module	778	1/5/50
------------------	--	-----	--------

AC23119MW	10A - Push for Bedlight - 2 Way - 2X1 - 2 Module	778	1/5/50
------------------	--	-----	--------

Reading Light



AC657MW

AC657MW	Reading Light LED - 2 Module	4188	1/12
----------------	------------------------------	------	------

Protectors & Accessories

Cat.Nos	Description	MRP* ₹ / Unit	Pack
---------	-------------	------------------	------

Surge Protector

AC627MW	Surge Protector - 1 Module	6692	20/200
----------------	----------------------------	------	--------

Motor Starter

AC20111MW	16A - Motor Starter - 2 Module	1332	1/10/100
------------------	--------------------------------	------	----------

AC20112MW	25A - Motor Starter - 2 Module	1368	1/10/100
------------------	--------------------------------	------	----------

Modular MCB

AC628MW	16A - SP - Modular MCB - C Curve - 1 Module	796	1/5/50
----------------	---	-----	--------

* MRP - Maximum Retail Price Inclusive of all taxes including GST.
Red Cat. Nos - New Products

Bold Cat.Nos are products normally available with Legrand (India) Stockists. Cat.Nos that are not bold - delivery within 4 - 8 weeks from the date of order. Bold packing quantity is our mandatory packing. Orders to be placed by Legrand (India) Stockist in multiples of the same.

Arteor Advance™

NEW! Protectors & Accessories

Cat.Nos	Description	MRP* ₹ / Unit	Pack
Modular MCB			
AC625MW	20A - SP - Modular MCB - C Curve - 1 Module	796	1/5/50
AC626MW	32A - SP - Modular MCB - C Curve - 1 Module	796	1/5/50



AC626MW

Audio-Video Sockets

AC4430MW	Female 3.5mm Jack - 1 Module	6684	1/10
AC4421MW	Preterminated Sockets Female Hd15 - 1 Module	9306	1/10
AC4411MW	Preterminated HDMI Socket - 1.4 - 1 Module	11044	1/10
AC4400MW	Loudspeaker Socket - 1 Module	1180	1/10/100
AC4452MW	Male XLR Jack - 2 Module	9484	1/20
AC4412MW	Preterminated HDMI Socket - 1.4 - 2 Module	11598	1/10
AC4106MW	TV-R-SAT Socket - 2 Module	5706	1/0/10
AC4442MW	Triple RCA Socket (Audio & Video) - 1 Module	6022	1/20
AC4362MW	Preterminated USB Data Socket - 1 Module	8322	1/10
AC4360MW	USB Socket - 1 Module	5268	2/0/20
AC4470MW	Line Dying Down - 100V (25 - 30W) - 2 Module	17522	1/20
AC4450MW	Female XLR Jack - 2 Module	10516	1/20
AC4440MW	2 Female RCA Socket - 1 Module	4888	1/10



AC4430MW



AC4411MW



AC4400MW



AC4452MW



AC4362MW



AC4470MW



AC4450MW

Arteor Advance™

NEW! Protectors & Accessories

Cat.Nos	Description	MRP* ₹ / Unit	Pack
Cable Outlet			
AC350MW	20A - Cable Outlet - 2 Module	1810	10/100
AC354MW	Cord Outlet - with 8mm Diameter - 1 Module	576	20/200



AC350MW

Blanking Plate

AC150MW	Blanking Plate - 1 Module	82	1/40/400
AC153MW	Blanking Plate - 2 Module	122	1/10/100



AC153MW

Mounting Accessories for Panel

A1401	Panel Mounting Support - 2 Module	500	10/100
--------------	-----------------------------------	-----	--------



A1401

Classic - Matt Black Mechanisms

Cat.Nos	Description	MRP* ₹ / Unit	Pack
Switches - 10A - 230V AC			
AC21104MB	10A - Switch - 1 Way - 1 Module	306	1/20/200
AC21106MB	10A - Switch - 1 Way - with Indicator - 1 Module	558	1/20/200
AC21105MB	10A - Switch - 1 Way - with Locator - 1 Module	558	1/20/200
AC22105MB	10A - Switch - 2 Way - 1 Module	500	1/20/200
AC22107MB	10A - Switch - 2 Way - with Indicator - 1 Module	714	1/20/200
AC21119MB	10A - Switch - 1 Way - with Indicator - 2 Module	632	1/10/100



AC21104MB



AC22105MB



AC21119MB

Switches - 16A - 230V AC

AC21101MB	16A - Switch - 1 Way - 1 Module	512	1/20/200
AC21118MB	16A - Switch - 1 Way - with Indicator - 1 Module	640	1/20/200
AC22101MB	16A - Switch - 2 Way - 1 Module	800	1/20/200
AC22102MB	16A - Switch - 2 Way - with Indicator - 1 Module	818	1/20/200
AC21103MB	16A - Switch - 1 Way - 2 Module	632	1/10/100
AC20109MB	16A - Intermediate Switch - 230V AC - 2 Module	3970	10/100
AC22109MB	16A - Switch - 2 Way - 2 Module	1036	1/10/100



AC21101MB



AC22102MB



AC22109MB

* MRP - Maximum Retail Price Inclusive of all taxes including GST.
Red Cat. Nos - New Products

Bold Cat.Nos are products normally available with Legrand (India) Stockists. Cat.Nos that are not bold - delivery within 4 - 8 weeks from the date of order. Bold packing quantity is our mandatory packing. Orders to be placed by Legrand (India) Stockist in multiples of the same.

Arteor Advance™

NEW! Classic - Matt Black Mechanisms

Cat.Nos	Description	MRP* ₹ / Unit	Pack
---------	-------------	------------------	------

Switches – 20A - 230V AC

AC21107MB	20A - Switch - 1 Way - 1 Module	664	1/20/200
AC21108MB	20A - Switch - 1 Way - with Indicator - 1 Module	768	1/20/200
AC22106MB	20A - Switch - 2 Way - 1 Module	862	1/20/200
AC22108MB	20A - Switch - 2 Way - with Indicator - 1 Module	958	1/20/200
AC21112MB	20A - Switch - 1 Way - 2 Module	784	1/10/100
AC22119MB	20A - Switch - 2 Way - 2 Module	924	1/10/100
AC22113MB	20A - Switch - SP - 2 Way - with Indicator - 2 Module	1030	1/10/100
AC21312MB	20A - Switch - 3 Gang - 1 Way - 2 Module	1894	1/10/100
AC29101MB	20A - Switch - 3 Gang - 2X2 Way + 1X1 Way - 2 Module	1984	1/10/100
AC21113MB	20A - Switch - DP - 1 Way - with Indicator - 2 Module	1534	1/10/100
AC20105MB	20A - Switch - DP - 1 Way - with Indicator & Water Heater Marking - 2 Module	1640	1/10/100

Switches – 25A - 230V AC

AC21115MB	25A - Switch - 1 Way - with Indicator - 1 Module	880	1/20/200
------------------	--	-----	----------

Switches – 32A - 230V AC

AC20101MB	32A - Switch - DP - 1 Way - with Indicator - 2 Module	2140	1/10/100
------------------	---	------	----------

Push Button – 10A - 230V AC

AC23102MB	10A - Bell Push - 1 Way - 1 Module	544	1/20/200
AC23103MB	10A - Bell Push - 1 Way - with Locator - 1 Module	752	1/20/200

* MRP - Maximum Retail Price Inclusive of all taxes including GST.
Red Cat. Nos - New Products

Arteor Advance™

NEW! Classic - Matt Black Mechanisms

Cat.Nos	Description	MRP* ₹ / Unit	Pack
---------	-------------	------------------	------

Push Button – 10A - 230V AC

AC23111MB	10A - Bell Push - 1 Way - 2 Module	778	1/10/100
AC23112MB	10A - Bell Push - 1 Way - with Locator - 2 Module	1048	1/10/100
AC23106MB	10A - Push Button - 1 Way - 1 Module	566	1/20/200
AC23107MB	10A - Push Button - 1 Way - with Locator - 1 Module	754	1/20/200
AC23108MB	10A - Push Button - 2 Way - 1 Module	830	1/5/50

Electric Roller Blinds

AC26104MB	Double Switch for Electric Shutter - 2 Module	1376	1/10/100
------------------	---	------	----------

Dimmers and Fan Regulators

AC24103MB	Light Dimmer - 60 to 400 Watts - 2 Module	2304	1/10/100
AC24105MB	Push Dimmer 0-10V - 2 Module	13324	1/20
AC24101MB	Push Dimmer 150W With Neutral - 1 Module	19032	1/5/20
AC24104MB	Push Dimmer 125W Without Neutral - 2 Module	12372	1/20
AC24106MB	Touch Dimmer 5-300W/75W - 2 Module	11882	1/20
AC24107MB	Rotary Dimmer 200W LED - 2 Module	21782	1/10
AC661MB	Fan Step Regulator - 100 Watts - ISI - 1 Module	1848	1/5/50
AC662MB	Fan Step Regulator - 100 Watts - ISI - 2 Module	2280	1/10/100
AC665MB	Fan Step Regulator - 70 Watts - ISI - 2 Module	2420	1/10/100
AC663MB	Fan Step Regulator - 120 Watts - ISI - 2 Module	2440	1/10/100
AC664MB	Fan Regulator - 8 Step - 100 Watts - ISI - 2 Module	2164	1/10/100

Bold Cat.Nos are products normally available with Legrand (India) Stockists. Cat.Nos that are not bold - delivery within 4 - 8 weeks from the date of order. Bold packing quantity is our mandatory packing. Orders to be placed by Legrand (India) Stockist in multiples of the same.

Arteor Advance™

NEW! Classic - Matt Black Mechanisms

Cat.Nos	Description	MRP* ₹ / Unit	Pack
---------	-------------	------------------	------

Indian Standard Sockets

AC3163MB	6A - Socket - with Shutter - 3 Pin - ISI - 2 Module	472	1/20/200
AC3166MB	6/16A - Socket - with Shutter - 3 Pin - Indian - ISI - 2 Module	922	1/10/100
AC3167MB	6/16A - Socket - with Shutter - 3 Pin - Indian - ISI - 3 Module	1122	1/5/50

USB Chargers

AC3408MB	USB Charger - 3000mA/15 Watts - Type A - 1 Module	4042	1/10/150
AC3410MB	USB Charger - 3000mA/15 Watts - Type A + A - 1 Module	4610	1/10/150
AC3411MB	USB Charger - 3000mA/15 Watts - Type A + C - 1 Module	5288	1/10/150
AC3412MB	USB Charger - 3000mA/15 Watts - Type C + C - 1 Module	5778	1/10/150
AC3409MB	USB Charger - Power Delivery - 20 Watts - Type C - 1 Module	7596	1/10/150
AC3406MB	USB Charger - Power Delivery - 30 Watts - Type C + C - 2 Module	11096	1/20
AC3401MB	USB Charger - Power Delivery - 45 Watts - Type C - 2 Module	14322	1/20
AC3415MB	USB Charger - Power Delivery - 65 Watts - Type C + C - 3 Module	17542	1/20

Data and Voice

AC423MB	Telephone Socket - Double RJ11 - 1 Module	860	1/20/200
AC424MB	Telephone Socket - RJ11 - with Shutter - 1 Module	520	1/20/200
AC4306MB	Information Socket - RJ45 - Cat 6A - UTP - 1 Module	2346	10/100
AC4315MB	Information Socket - RJ45 Rear Pluggable - CAT6 - UTP - 2 Module	5824	1/10/100

TV Sockets

AC4110MB	TV Co - axial Socket - 1 Module	524	1/20/200
-----------------	---------------------------------	-----	----------

Arteor Advance™

NEW! Classic - Matt Black Mechanisms

Cat.Nos	Description	MRP* ₹ / Unit	Pack
---------	-------------	------------------	------

Electronic Chime

AC618MB	Bell Ding Dong - 230V - 2 Module	856	1/10/100
----------------	----------------------------------	-----	----------

Buzzer

AC615MB	Buzzer - 230V - 1 Module	2318	10/60
----------------	--------------------------	------	-------

Bell Call Indicator

AC23105MB	Bell Call Indicator - 1 Module	3534	1/20/200
------------------	--------------------------------	------	----------

Infrared Sensors

AC25102MB	IR Motion Sensor with Neutral - 2 Module	14862	1/20
------------------	--	-------	------

Innovative Switch

AC28102MB	Contactless Door Switch - 12-24-48 V - 2 Module	8586	1/20
AC28101MB	Contactless Light Switch - 230V AC - 2 Module	7728	1/20

Skirting Light

AC653MB	Skirting Light - with LED - 230V - 3 Module	1900	10/100
----------------	---	------	--------

Protectors & Accessories

Cat.Nos	Description	MRP* ₹ / Unit	Pack
---------	-------------	------------------	------

Hotel "DND and MMR" functions

AC27107MB	Interlocked Internal DND & MMR Control Unit - 2 Module	2734	1/10/100
AC27108MB	External DND & MMR Control Unit - with Bell Push - 2 Module	3778	1/5/50

Hotel Keycard Switch

AC27110MB	16A - Key Card Switch - 230V - 2 Module	9908	1/20
AC27111MB	16A - Key Card Switch with RFID - 230V - 2 Module	10336	1/20

Shaver Socket

AC361MB	Shaver Socket - 230V/120 - 230V - with Earth Connector	10302	1/10
----------------	--	-------	------

Time Switch

AC20110MB	Time Delay Switch - 2 Module	12220	1/20
------------------	------------------------------	-------	------

* MRP - Maximum Retail Price Inclusive of all taxes including GST.
Red Cat. Nos - New Products

Bold Cat.Nos are products normally available with Legrand (India) Stockists. Cat.Nos that are not bold - delivery within 4 - 8 weeks from the date of order. Bold packing quantity is our mandatory packing. Orders to be placed by Legrand (India) Stockist in multiples of the same.

Arteor Advance™

NEW! Hospitality Function

Cat.Nos	Description	MRP* ₹ / Unit	Pack
---------	-------------	------------------	------

Master Switch

AC22114MB	20A - Master Switch - DP - 2 Way - ON/OFF - 2 Module	948	1/10/100
AC23115MB	Master Push ON/OFF - 2 Way - 2 Module	908	1/10/100



AC22114MB

Bedlight Switch

AC21117MB	10A - Bedlight Switch - 2 Way - 2X1 - 2 Module	908	1/5/50
AC23119MB	10A - Push for Bedlight - 2 Way - 2X1 - 2 Module	908	1/5/50



AC657MB

Reading Light

AC657MB	Reading Light LED - 2 Module	4348	1/12
----------------	------------------------------	------	------

Protectors & Accessories

Surge Protector

AC627MB	Surge Protector - 1 Module	7364	20/200
----------------	----------------------------	------	--------



AC627MB

Motor Starter

AC20111MB	16A - Motor Starter - 2 Module	1566	1/10/100
AC20112MB	25A - Motor Starter - 2 Module	1604	1/10/100



AC20112MB

Modular MCB

AC628MB	16A - SP - Modular MCB - C Curve - 1 Module	916	1/5/50
AC625MB	20A - SP - Modular MCB - C Curve - 1 Module	916	1/5/50
AC626MB	32A - SP - Modular MCB - C Curve - 1 Module	916	1/5/50



AC628MB



AC626MB

Audio-Video Sockets

AC4430MB	Female 3.5mm Jack - 1 Module	7424	1/10
AC4421MB	Preterminated Sockets Female Hd15 - 1 Module	10240	1/10
AC4411MB	Preterminated HDMI Socket - 1.4 - 1 Module	11604	1/10
AC4400MB	Loudspeaker Socket - 1 Module	1300	1/10/100
AC4452MB	Male XLR Jack - 2 Module	10954	1/20
AC4412MB	Preterminated HDMI Socket - 1.4 - 2 Module	12188	1/10
AC4106MB	TV-R-SAT Socket - 2 Module	6582	1/0/10



AC4430MB



AC4411MB



AC4400MB



AC4106MB

Arteor Advance™

NEW! Protectors & Accessories

Cat.Nos	Description	MRP* ₹ / Unit	Pack
---------	-------------	------------------	------

Audio-Video Sockets

AC4442MB	Triple RCA Socket (Audio & Video) - 1 Module	6526	1/20
AC4362MB	Preterminated USB Data Socket - 1 Module	8754	1/10
AC4360MB	USB Socket - 1 Module	5882	2/0/20
AC4470MB	Line Dying Down - 100V (25 - 30W) - 2 Module	20912	1/20
AC4450MB	Female XLR Jack - 2 Module	13178	1/20
AC4440MB	2 Female RCA Socket - 1 Module	5318	1/10



AC4362MB



AC4360MB



AC4470MB

Cable Outlet

AC354MB	Cord Outlet - with 8mm Diameter - 1 Module	638	20/200
----------------	--	-----	--------



AC354MB

Blanking Plate

AC150MB	Blanking Plate - 1 Module	80	1/40/400
AC153MB	Blanking Plate - 2 Module	138	1/10/100



AC153MB

Classic - Matt Titanium Mechanisms

Switches - 10A - 230V AC

AC21104MT	10A - Switch - 1 Way - 1 Module	306	1/20/200
AC21106MT	10A - Switch - 1 Way - with Indicator - 1 Module	558	1/20/200
AC21105MT	10A - Switch - 1 Way - with Locator - 1 Module	558	1/20/200
AC22105MT	10A - Switch - 2 Way - 1 Module	500	1/20/200
AC22107MT	10A - Switch - 2 Way - with Indicator - 1 Module	714	1/20/200
AC21119MT	10A - Switch - 1 Way - with Indicator - 2 Module	632	1/10/100



AC21104MT



AC22105MT



AC21119MT

* MRP - Maximum Retail Price Inclusive of all taxes including GST.
Red Cat. Nos - New Products

Bold Cat.Nos are products normally available with Legrand (India) Stockists. Cat.Nos that are not bold - delivery within 4 - 8 weeks from the date of order. Bold packing quantity is our mandatory packing. Orders to be placed by Legrand (India) Stockist in multiples of the same.

Arteor Advance™

NEW! Classic - Matt Titanium Mechanisms

Cat.Nos	Description	MRP* ₹ / Unit	Pack
---------	-------------	------------------	------

Switches – 16A - 230V AC

AC21101MT	16A - Switch - 1 Way - 1 Module	512	20/200
AC21118MT	16A - Switch - 1 Way - with Indicator - 1 Module	640	1/20/200
AC22201MT	16A - Switch - 2 Way - 1 Module	800	1/20/200
AC22202MT	16A - Switch - 2 Way - with Indicator - 1 Module	818	1/20/200
AC21103MT	16A - Switch - 1 Way - 2 Module	632	1/10/100
AC20109MT	16A - Intermediate Switch - 230V AC - 2 Module	3970	1/10/100
AC22209MT	16A - Switch - 2 Way - 2 Module	1036	1/10/100

Switches – 20A - 230V AC

AC21107MT	20A - Switch - 1 Way - 1 Module	664	1/20/200
AC21108MT	20A - Switch - 1 Way - with Indicator - 1 Module	768	1/20/200
AC22206MT	20A - Switch - 2 Way - 1 Module	862	1/20/200
AC22208MT	20A - Switch - 2 Way - with Indicator - 1 Module	958	1/20/200
AC21112MT	20A - Switch - 1 Way - 2 Module	784	1/10/100
AC22219MT	20A - Switch - 2 Way - 2 Module	924	1/10/100
AC22213MT	20A - Switch - 2 Way - with Indicator - 2 Module	1030	1/10/100
AC21312MT	20A - Switch - 3 Gang - 1 Way - 2 Module	1894	1/10/100
AC29101MT	20A - Switch - 3 Gang - 2X2 Way + 1X1 Way - 2 Module	1984	1/10/100
AC21113MT	20A - Switch - DP - 1 Way - with Indicator - 2 Module	1534	1/10/100
AC20105MT	20A - Switch - DP - 1 Way - with Indicator & Water Heater Marking - 2 Module	1640	1/10/100

Arteor Advance™

NEW! Classic - Matt Titanium Mechanisms

Cat.Nos	Description	MRP* ₹ / Unit	Pack
---------	-------------	------------------	------

Switches – 25A - 230V AC

AC21115MT	25A - Switch - 1 Way - with Indicator - 1 Module	880	1/20/200
------------------	--	-----	----------

Switches – 32A - 230V AC

AC20101MT	32A - Switch - DP - 1 Way - with Indicator - 2 Module	2140	1/10/100
------------------	---	------	----------

Push Button – 10A - 230V AC

AC23102MT	10A - Bell Push - 1 Way - 1 Module	544	1/20/200
AC23103MT	10A - Bell Push - 1 Way - with Locator - 1 Module	752	1/20/200
AC23111MT	10A - Bell Push - 1 Way - 2 Module	778	1/10/100
AC23112MT	10A - Bell Push - 1 Way - with Locator - 2 Module	1048	1/10/100
AC23106MT	10A - Push Button - 1 Way - 1 Module	566	1/20/200
AC23107MT	10A - Push Button - 1 Way - with Locator - 1 Module	754	1/20/200
AC23108MT	10A - Push Button - 2 Way - 1 Module	830	1/5/50

Electric Roller Blinds

AC26104MT	Double Switch for Electric Shutter - 2 Module	1432	1/10/100
------------------	---	------	----------

Dimmers and Fan Regulators

AC24103MT	Light Dimmer - 60 to 400 Watts - 2 Module	2304	1/10/100
AC24105MT	Push Dimmer 0-10V - 2 Module	13862	1/20
AC24101MT	Push Dimmer 150W With Neutral - 1 Module	19802	1/5/20
AC24104MT	Push Dimmer 125W Without Neutral - 2 Module	12872	1/20
AC24106MT	Touch Dimmer 5-300W/75W - 2 Module	11882	1/20
AC24107MT	Rotary Dimmer 200W LED - 2 Module	21782	1/10
AC661MT	Fan Step Regulator - 100 Watts - ISI - 1 Module	1848	1/5/50
AC662MT	Fan Step Regulator - 100 Watts - ISI - 2 Module	2280	1/10/100
AC665MT	Fan Step Regulator - 70 Watts - ISI - 2 Module	2420	1/10/100
AC663MT	Fan Step Regulator - 120 Watts - ISI - 2 Module	2440	1/10/100
AC664MT	Fan Regulator - 8 Step - 100 Watts - ISI - 2 Module	2164	1/10/100

* MRP - Maximum Retail Price Inclusive of all taxes including GST.
Red Cat. Nos - New Products

Bold Cat.Nos are products normally available with Legrand (India) Stockists. Cat.Nos that are not bold - delivery within 4 - 8 weeks from the date of order. Bold packing quantity is our mandatory packing. Orders to be placed by Legrand (India) Stockist in multiples of the same.

Arteor Advance™

NEW! Classic - Matt Titanium Mechanisms

Cat.Nos	Description	MRP* ₹ / Unit	Pack
---------	-------------	------------------	------

Indian Standard Sockets

AC3163MT	6A - Socket - with Shutter - 3 Pin - ISI - 2 Module	472	1/20/200
AC3166MT	6/16A - Socket - with Shutter - 3 Pin - Indian - ISI - 2 Module	922	1/10/100
AC3167MT	6/16A - Socket - with Shutter - 3 Pin - Indian - ISI - 3 Module	1122	1/5/50

USB Chargers

AC3408MT	USB Charger - 3000mA/15 Watts - Type A - 1 Module	4042	1/10/150
AC3410MT	USB Charger - 3000mA/15 Watts - Type A + A - 1 Module	4610	1/10/150
AC3411MT	USB Charger - 3000mA/15 Watts - Type A + C - 1 Module	5288	1/10/150
AC3412MT	USB Charger - 3000mA/15 Watts - Type C + C - 1 Module	5778	1/10/150
AC3409MT	USB Charger - Power Delivery - 20 Watts - Type C - 1 Module	7596	1/10/150
AC3406MT	USB Charger - Power Delivery - 30 Watts - Type C + C - 2 Module	11096	1/20
AC3401MT	USB Charger - Power Delivery - 45 Watts - Type C - 2 Module	14322	1/20
AC3415MT	USB Charger - Power Delivery - 65 Watts - Type C + C - 3 Module	17542	1/20

Data and Voice

AC423MT	Telephone Socket - Double RJ11 - 1 Module	860	1/20/200
AC424MT	Telephone Socket - RJ11 - with Shutter - 1 Module	520	1/20/200
AC4306MT	Information Socket - RJ45 - Cat 6A - UTP - 1 Module	2346	10/100
AC4315MT	Information Socket - RJ45 Rear Pluggable - CAT6 - UTP - 2 Module	5824	1/10/100

TV Sockets

AC4110MT	TV Co - axial Socket - 1 Module	524	1/20/200
-----------------	---------------------------------	-----	----------

Arteor Advance™

NEW! Classic - Matt Titanium Mechanisms

Cat.Nos	Description	MRP* ₹ / Unit	Pack
---------	-------------	------------------	------

Electronic Chime

AC618MT	Bell Ding Dong - 230V - 2 Module	856	1/10/100
----------------	----------------------------------	-----	----------

Buzzer

AC615MT	Buzzer - 230V - 1 Module	2318	10/60
----------------	--------------------------	------	-------

Bell Call Indicator

AC23105MT	Bell Call Indicator - 1 Module	3534	1/20/200
------------------	--------------------------------	------	----------

Infrared Sensors

AC25102MT	IR Motion Sensor with Neutral - 2 Module	14862	1/20
------------------	--	-------	------

Innovative Switch

AC28102MT	Contactless Door Switch - 12-24-48 V - 2 Module	8586	1/20
AC28101MT	Contactless Light Switch - 230V AC - 2 Module	7728	1/20

Skirting Light

AC653MT	Skirting Light - with LED - 230V - 3 Module	1900	10/100
----------------	---	------	--------

Hospitality Function

Hotel "DND and MMR" functions

AC27107MT	Interlocked Internal DND & MMR Control Unit - 2 Module	2734	1/10/100
AC27108MT	External DND & MMR Control Unit - with Bell Push - 2 Module	3778	1/5/50

Hotel Keycard Switch

AC27110MT	16A - Key Card Switch - 230V - 2 Module	9908	1/20
AC27111MT	16A - Key Card Switch with RFID - 230V - 2 Module	10336	1/20

Shaver Socket

AC361MT	Shaver Socket - 230V/120 - 230V - with Earth Connector	10302	1/10
----------------	--	-------	------

Time Switch

AC20110MT	Time Delay Switch - 2 Module	12220	1/20
------------------	------------------------------	-------	------

* MRP - Maximum Retail Price Inclusive of all taxes including GST.
Red Cat. Nos - New Products

Bold Cat.Nos are products normally available with Legrand (India) Stockists. Cat.Nos that are not bold - delivery within 4 - 8 weeks from the date of order. Bold packing quantity is our mandatory packing. Orders to be placed by Legrand (India) Stockist in multiples of the same.

Arteor Advance™

NEW! Hospitality Function

Cat.Nos	Description	MRP* ₹ / Unit	Pack
---------	-------------	------------------	------

Master Switch

AC22114MT	20A - Master Switch - DP - 2 Way - ON/OFF - 2 Module	948	1/10/100
AC23115MT	Master Push ON/OFF - 2 Way - 2 Module	908	1/10/100

Bedlight Switch

AC21117MT	10A - Bedlight Switch - 2 Way - 2X1 2 Module	908	1/5/50
AC23119MT	10A - Push for Bedlight - 2 Way - 2X1 2 Module	908	1/5/50

Arteor Advance™

Protectors & Accessories

Surge Protector

AC627MT	Surge Protector - 1 Module	7364	20/200
----------------	----------------------------	------	--------

Motor Starter

AC20111MT	16A - Motor Starter - 2 Module	1566	1/10/100
AC20112MT	25A - Motor Starter - 2 Module	1604	1/10/100

Modular MCB

AC628MT	16A - SP - Modular MCB - C Curve - 1 Module	916	1/5/50
AC625MT	20A - SP - Modular MCB - C Curve - 1 Module	916	1/5/50
AC626MT	32A - SP - Modular MCB - C Curve - 1 Module	916	1/5/50

Audio-Video Sockets

AC4430MT	Female 3.5mm Jack - 1 Module	7424	1/10
AC4421MT	Preterminated Sockets Female Hd15 - 1 Module	10240	1/10
AC4411MT	Preterminated HDMI Socket - 1.4 - 1 Module	11604	1/10
AC4400MT	Loudspeaker Socket - 1 Module	1300	1/10/100
AC4452MT	Male XLR Jack - 2 Module	10954	1/20

Arteor Advance™

NEW! Protectors & Accessories

Cat.Nos	Description	MRP* ₹ / Unit	Pack
---------	-------------	------------------	------

Audio-Video Sockets

AC4412MT	Preterminated HDMI Socket - 1.4 - 2 Module	12188	1/10
AC4106MT	TV-R-SAT Socket - 2 Module	6582	1/0/10
AC4442MT	Triple RCA Socket (Audio & Video) - 1 Module	6526	1/20
AC4362MT	Preterminated USB Data Socket - 1 Module	8754	1/10
AC4360MT	USB Socket - 1 Module	5882	2/0/20
AC4470MT	Line Dying Down - 100V (25 - 30W) - 2 Module	21094	1/20
AC4450MT	Female XLR Jack - 2 Module	13178	1/20
AC4440MT	2 Female RCA Socket - 1 Module	5318	1/10

Cable Outlet

AC354MT	Cord Outlet - with 8mm Diameter - 1 Module	632	20/200
----------------	--	-----	--------

Blanking Plate

AC150MT	Blanking Plate - 1 Module	80	1/40/400
AC153MT	Blanking Plate - 2 Module	138	1/10/100

Elite Matt White Mechanisms

Cat.Nos	Description	MRP* ₹ / Unit	Pack
---------	-------------	------------------	------

Switches - 10A - 230V AC

AA21104MW	10A - Switch - 1 Way - 1 Module	316	1/10/100
AA21106MW	10A - Switch - 1 Way - with Indicator - 1 Module	586	1/10/100
AA21105MW	10A - Switch - 1 Way - with Locator - 1 Module	586	1/10/100
AA21102MW	10A - Switch - 1 Way - with Locator (Blue) - 1 Module	586	1/10/100
AA22105MW	10A - Switch - 2 Way - 1 Module	520	1/10/100
AA22107MW	10A - Switch - 2 Way - with Indicator - 1 Module	732	1/10/100

* MRP - Maximum Retail Price Inclusive of all taxes including GST.
Red Cat. Nos - New Products

Bold Cat.Nos are products normally available with Legrand (India) Stockists. Cat.Nos that are not bold - delivery within 4 - 8 weeks from the date of order. Bold packing quantity is our mandatory packing. Orders to be placed by Legrand (India) Stockist in multiples of the same.

Arteor Advance™

NEW! Elite Matt White Mechanisms

Cat.Nos	Description	MRP* ₹ / Unit	Pack
---------	-------------	------------------	------

Switches – 16A - 230V AC

AA21101MW	16A - Switch - 1 Way - 1 Module	528	1/10/100
AA21120MW	16A - Switch - 1 Way - with Indicator - 1 Module	676	1/10/100
AA22101MW	16A - Switch - 2 Way - 1 Module	828	1/10/100
AA22102MW	16A - Switch - 2 Way - with Indicator - 1 Module	842	1/10/100

Switches – 20A - 230V AC

AA21107MW	20A - Switch - 1 Way - 1 Module	702	1/10/100
AA21108MW	20A - Switch - 1 Way - with Indicator - 1 Module	798	1/10/100
AA22106MW	20A - Switch - 2 Way - 1 Module	914	1/10/100
AA22108MW	20A - Switch - 2 Way - with Indicator - 1 Module	1016	1/10/100

Push Button – 10A - 230V AC

AA23102MW	10A - Bell Push - 1 Way - 1 Module	582	1/10/100
AA23103MW	10A - Bell Push - 1 Way - with Locator - 1 Module	772	1/10/100
AA23104MW	10A - Bell Push - 1 Way - with Locator (Blue) - 1 Module	772	1/10/100
AA23101MW	10A - Push Button - 1 Way - 1 Module	616	1/10/100
AA23108MW	10A - Push Button - 2 Way - 1 Module	856	1/10/100

Electric Roller Blinds

AA26104MW	Double Switch for Electric Shutter - 2 Module	1420	1/5/50
------------------	---	------	--------

Dimmers and Fan Regulators

AA24107MW	Rotary Dimmer 200W LED - 2 Module	24158	1/10
AA667MW	Fan Step Regulator - 70 Watts - ISI - 2 Module	2532	1/3/30
AA664MW	Fan Regulator - 8 Step - 100 Watts - ISI - 2 Module	2264	1/3/30
AA669MW	Fan Step Regulator - 120 Watts - ISI - 2 Module	2540	1/3/30

Temperature Room Control Unit

AA674MW	Temperature Room Control Unit	20502	1/20
----------------	-------------------------------	-------	------

USB Chargers

AA3406MW	USB Charger - Power Delivery - 30 Watts - Type C + C - 2 Module	12730	1/20
AA3401MW	USB Charger - Power Delivery - 45 Watts - Type C - 2 Module	16428	1/20

* MRP - Maximum Retail Price Inclusive of all taxes including GST.
Red Cat. Nos - New Products

Arteor Advance™

NEW! Hospitality Function

Cat.Nos	Description	MRP* ₹ / Unit	Pack
---------	-------------	------------------	------

Hotel "DND and MMR" functions

AA27107MW	Interlocked Internal DND & MMR Control Unit - 2 Module	2838	1/5/50
AA27108MW	External DND & MMR Control Unit - with Bell Push - 2 Module	3956	1/5/50

Master Push Button

AA23115MW	Master Push ON/OFF - 2 Way - 1 Module	954	1/10/100
------------------	---------------------------------------	-----	----------

Bedlight Switch

AA21117MW	10A - Bedlight Switch - 2 Way - 2X1 2 Module	934	1/5/50
AA23119MW	10A - Push for Bedlight - 2 Way - 2X1 2 Module	934	1/5/50

Blanking Plate

AA150MW	Blanking Plate - 1 Module	102	1/10/100
----------------	---------------------------	-----	----------

Arteor Advance™

Elite Matt Black Mechanisms

Cat.Nos	Description	MRP* ₹ / Unit	Pack
---------	-------------	------------------	------

Switches – 10A - 230V AC

AA21104MB	10A - Switch - 1 Way - 1 Module	368	1/10/100
AA21106MB	10A - Switch - 1 Way - with Indicator - 1 Module	668	1/10/100
AA21105MB	10A - Switch - 1 Way - with Locator - 1 Module	668	1/10/100
AA22105MB	10A - Switch - 2 Way - 1 Module	600	1/10/100
AA22107MB	10A - Switch - 2 Way - with Indicator - 1 Module	856	1/10/100

Switches – 16A - 230V AC

AA21101MB	16A - Switch - 1 Way - 1 Module	616	1/10/100
AA21120MB	16A - Switch - 1 Way - with Indicator - 1 Module	768	1/10/100
AA22101MB	16A - Switch - 2 Way - 1 Module	958	1/10/100
AA22102MB	16A - Switch - 2 Way - with Indicator - 1 Module	984	1/10/100

Switches – 20A - 230V AC

AA21107MB	20A - Switch - 1 Way - 1 Module	798	1/10/100
AA21108MB	20A - Switch - 1 Way - with Indicator - 1 Module	920	1/10/100
AA22106MB	20A - Switch - 2 Way - 1 Module	1034	1/10/100
AA22108MB	20A - Switch - 2 Way - with Indicator - 1 Module	1148	1/10/100

Bold Cat.Nos are products normally available with Legrand (India) Stockists. Cat.Nos that are not bold - delivery within 4 - 8 weeks from the date of order. Bold packing quantity is our mandatory packing. Orders to be placed by Legrand (India) Stockist in multiples of the same.

Arteor Advance™

NEW! Elite Matt Black Mechanisms

Cat.Nos	Description	MRP* ₹ / Unit	Pack
---------	-------------	------------------	------

Push Button – 10A - 230V AC

AA23102MB	10A - Bell Push - 1 Way - 1 Module	654	1/10/100
AA23103MB	10A - Bell Push - 1 Way - with Locator - 1 Module	902	1/10/100
AA23101MB	10A - Push Button - 1 Way - 1 Module	680	1/10/100
AA23108MB	10A - Push Button - 2 Way - 1 Module	996	1/5/50

AA23102MB

AA23101MB

AA23101MB

Electric Roller Blinds and Curtain Control

AA26104MB	Double Switch for Electric Shutter - 2 Module	1650	1/5/50
------------------	---	------	--------

Dimmers and Fan Regulators

AA24107MB	Rotary Dimmer 200W LED - 2 Module	26138	1/10
AA667MB	Fan Step Regulator - 70 Watts - ISI - 2 Module	2904	1/3/30
AA664MB	Fan Regulator - 8 Step - 100 Watts - ISI - 2 Module	2598	1/3/30
AA669MB	Fan Step Regulator - 120 Watts - ISI - 2 Module	2928	1/3/30

AA24107MB

AA664MB

Temperature Room Control Unit

AA674MB	Temperature Room Control Unit	23578	1/20
----------------	-------------------------------	-------	------

AA674MB

USB Chargers

AA3406MB	USB Charger - Power Delivery - 30 Watts - Type C + C - 2 Module	13318	1/20
AA3401MB	USB Charger - Power Delivery - 45 Watts - Type C - 2 Module	17184	1/20

AA3406MB

Arteor Advance™

Hospitality Function

Hotel "DND and MMR" functions

AA27107MB	Interlocked Internal DND & MMR Control Unit - 2 Module	3278	1/5/50
AA27108MB	External DND & MMR Control Unit - with Bell Push - 2 Module	4532	1/5/50

AA27107MB

Arteor Advance™

NEW! Hospitality Function

Cat.Nos	Description	MRP* ₹ / Unit	Pack
---------	-------------	------------------	------

Master Push Button

AA23115MB	Master Push ON/OFF - 2 Way - 1 Module	1088	1/10/100
------------------	---------------------------------------	------	----------

AA23115MB

Bedlight Switch

AA21117MB	10A - Bedlight Switch - 2 Way - 2X1 2 Module	1088	1/5/50
AA23119MB	10A - Push for Bedlight - 2 Way - 2X1 2 Module	1088	1/5/50

AA21117MB

Blanking Plate

AA150MB	Blanking Plate - 1 Module	98	1/10/100
----------------	---------------------------	----	----------

AA150MB

Arteor Advance™

Elite - Matt Titanium Mechanisms

Cat.Nos	Description	MRP* ₹ / Unit	Pack
---------	-------------	------------------	------

Switches – 10A - 230V AC

AA21104MT	10A - Switch - 1 Way - 1 Module	368	1/10/100
AA21106MT	10A - Switch - 1 Way - with Indicator - 1 Module	668	1/10/100
AA21105MT	10A - Switch - 1 Way - with Locator - 1 Module	668	1/10/100
AA22105MT	10A - Switch - 2 Way - 1 Module	600	1/10/100
AA22107MT	10A - Switch - 2 Way - with Indicator - 1 Module	856	1/10/100

AA21104MT

AA21105MT

AA22107MT

Switches – 16A - 230V AC

AA21101MT	16A - Switch - 1 Way - 1 Module	616	1/10/100
AA21120MT	16A - Switch - 1 Way - with Indicator - 1 Module	768	1/10/100
AA22101MT	16A - Switch - 2 Way - 1 Module	958	1/10/100
AA22102MT	16A - Switch - 2 Way - with Indicator - 1 Module	984	1/10/100

AA21101MT

AA22102MT

Switches – 20A - 230V AC

AA21107MT	20A - Switch - 1 Way - 1 Module	798	1/10/100
AA21108MT	20A - Switch - 1 Way - with Indicator - 1 Module	920	1/10/100
AA22106MT	20A - Switch - 2 Way - 1 Module	1034	1/10/100
AA22108MT	20A - Switch - 2 Way - with Indicator - 1 Module	1148	1/10/100

AA21107MT

AA22106MT

* MRP - Maximum Retail Price Inclusive of all taxes including GST.
Red Cat. Nos - New Products

Bold Cat.Nos are products normally available with Legrand (India) Stockists. Cat.Nos that are not bold - delivery within 4 - 8 weeks from the date of order. Bold packing quantity is our mandatory packing. Orders to be placed by Legrand (India) Stockist in multiples of the same.

Arteor Advance™

NEW! Elite - Matt Titanium Mechanisms

Cat.Nos	Description	MRP* ₹ / Unit	Pack
---------	-------------	------------------	------

Push Button – 10A - 230V AC

AA23102MT	10A - Bell Push - 1 Way - 1 Module	654	1/10/100
AA23103MT	10A - Bell Push - 1 Way - with Locator - 1 Module	902	1/10/100
AA23101MT	10A - Push Button - 1 Way - 1 Module	680	1/10/100
AA23108MT	10A - Push Button - 2 Way - 1 Module	996	1/5/50

Electric Roller Blinds and Curtain Control

AA26104MT	Double Switch for Electric Shutter - 2 Module	1650	1/5/50
------------------	---	------	--------

Dimmers and Fan Regulators

AA24107MT	Rotary Dimmer 200W LED - 2 Module	26138	1/10
AA667MT	Fan Step Regulator - 70 Watts - ISI - 2 Module	2904	1/3/30
AA664MT	Fan Regulator - 8 Step - 100 Watts - ISI - 2 Module	2598	1/3/30
AA669MT	Fan Step Regulator - 120 Watts - ISI - 2 Module	2928	1/3/30

Temperature Room Control Unit

AA674MT	Temperature Room Control Unit	23578	1/20
----------------	-------------------------------	-------	------

USB Chargers

AA3406MT	USB Charger - Power Delivery - 30 Watts - Type C + C - 2 Module	13318	1/20
AA3401MT	USB Charger - Power Delivery - 45 Watts - Type C - 2 Module	17184	1/20

Hospitality Function

Cat.Nos	Description	MRP* ₹ / Unit	Pack
---------	-------------	------------------	------

Hotel "DND and MMR" functions

AA27107MT	Interlocked Internal DND & MMR Control Unit - 2 Module	3278	1/5/50
AA27108MT	External DND & MUR Control Unit - with Bell Push - 2 Module	4532	1/5/50

Arteor Advance™

NEW! Classic- Cover Plate with Support Frame

Cat.Nos	Description	MRP* ₹ / Unit	Pack
---------	-------------	------------------	------

Master Push Button

AA23115MT	Master Push ON/OFF - 2 Way - 1 Module	1088	1/10/100
------------------	---------------------------------------	------	----------

Bedlight Switch

AA21117MT	10A - Bedlight Switch - 2 Way - 2X1 2 Module	1088	1/5/50
AA23119MT	10A - Push for Bedlight - 2 Way - 2X1 2 Module	1088	1/5/50

Blanking Plate

AA150MT	Blanking Plate - 1 Module	98	1/10/100
----------------	---------------------------	----	----------

White Cover Plate with Support Frame

AC1200MW	Cover Plate + Frame - 1 Module - Matt White	510	10/100
AC1201MW	Cover Plate + Frame - 2 Module - Matt White	528	10/100
AC1202MW	Cover Plate + Frame - 3 Module - Matt White	612	10/100
AC1203MW	Cover Plate + Frame - 4 Module - Matt White	700	5/50
AC1205MW	Cover Plate + Frame - 6 Module - Matt White	964	5/30
AC1207MW	Cover Plate + Frame - 8 Module - Matt White	1140	5/30
AC1208MW	Cover Plate + Frame - 2*4 Module - Matt White	1666	2/20
AC1212MW	Cover Plate + Frame - 9 Module - Matt White	1768	5/30
AC1210MW	Cover Plate + Frame - 2*6 Module - Matt White	2216	2/16
AC1213MW	Cover Plate + Frame - 2*8 Module - Matt White	2436	2/16
AC1211MW	Cover Plate + Frame - 3*6 Module - Matt White	2872	2/12
AC1136MW	Cover Plate - for Shaver Socket-3 Module - Matt White	638	5/50

Matt Black Cover Plate with Support Frame

AC1200MB	Cover Plate + Frame - 1 Module - Matt Black	614	10/100
AC1201MB	Cover Plate + Frame - 2 Module - Matt Black	648	10/100
AC1202MB	Cover Plate + Frame - 3 Module - Matt Black	686	10/100
AC1203MB	Cover Plate + Frame - 4 Module - Matt Black	778	5/50
AC1205MB	Cover Plate + Frame - 6 Module - Matt Black	1330	5/30

* MRP - Maximum Retail Price Inclusive of all taxes including GST.
Red Cat. Nos - New Products

Bold Cat.Nos are products normally available with Legrand (India) Stockists. Cat.Nos that are not bold - delivery within 4 - 8 weeks from the date of order. Bold packing quantity is our mandatory packing. Orders to be placed by Legrand (India) Stockist in multiples of the same.

Arteor Advance™

NEW! Classic- Cover Plate with Support Frame

Cat.Nos	Description	MRP* ₹ / Unit	Pack
---------	-------------	------------------	------

Matt Black Cover Plate with Support Frame

AC1207MB	Cover Plate + Frame - 8 Module - Matt Black	1476	5/30
AC1208MB	Cover Plate + Frame - 2*4 Module - Matt Black	1872	2/20
AC1212MB	Cover Plate + Frame - 9 Module - Matt Black	1986	5/30
AC1210MB	Cover Plate + Frame - 2*6 Module - Matt Black	2430	2/16
AC1213MB	Cover Plate + Frame - 2*8 Module - Matt Black	2760	2/16
AC1211MB	Cover Plate + Frame - 3*6 Module - Matt Black	3226	2/12
AC1136MB	Cover Plate - for Shaver Socket-3 Module - Matt Black	1048	5/50

Matt Titanium Cover Plate with Support Frame

AC1200MT	Cover Plate + Frame - 1 Module - Matt Titanium	614	10/100
AC1201MT	Cover Plate + Frame - 2 Module - Matt Titanium	648	10/100
AC1202MT	Cover Plate + Frame - 3 Module - Matt Titanium	686	10/100
AC1203MT	Cover Plate + Frame - 4 Module - Matt Titanium	778	5/50
AC1205MT	Cover Plate + Frame - 6 Module - Matt Titanium	1330	5/30
AC1207MT	Cover Plate + Frame - 8 Module - Matt Titanium	1476	5/30
AC1208MT	Cover Plate + Frame - 2*4 Module - Matt Titanium	1872	2/20
AC1212MT	Cover Plate + Frame - 9 Module - Matt Titanium	1986	5/30
AC1210MT	Cover Plate + Frame - 2*6 Module - Matt Titanium	2430	2/16
AC1213MT	Cover Plate + Frame - 2*8 Module - Matt Titanium	2760	2/16
AC1211MT	Cover Plate + Frame - 3*6 Module - Matt Titanium	3226	2/12
AC1136MT	Cover Plate - for Shaver Socket-3 Module - Matt Titanium	1048	5/50

Frosted White Cover Plate with Support Frame

AC1200FW	Cover Plate + Frame - 1 Module - Frosted White	788	1/5/30
AC1201FW	Cover Plate + Frame - 2 Module - Frosted White	842	1/5/30
AC1202FW	Cover Plate + Frame - 3 Module - Frosted White	902	1/20
AC1203FW	Cover Plate + Frame - 4 Module - Frosted White	960	1/20

Arteor Advance™

NEW! Classic- Cover Plate with Support Frame

Cat.Nos	Description	MRP* ₹ / Unit	Pack
---------	-------------	------------------	------

Frosted White Cover Plate with Support Frame

AC1205FW	Cover Plate + Frame - 6 Module - Frosted White	1746	1/5/30
AC1207FW	Cover Plate + Frame - 8 Module - Frosted White	1922	1/5/30
AC1208FW	Cover Plate + Frame - 2*4 Module - Frosted White	2482	1/10
AC1210FW	Cover Plate + Frame - 2*6 Module - Frosted White	2998	1/16
AC1136FW	Cover Plate - for Shaver Socket-3 Module - Frosted White	1840	1/5/50

Frosted Black Cover Plate with Support Frame

AC1200FB	Cover Plate + Frame - 1 Module - Frosted Black	788	1/5/30
AC1201FB	Cover Plate + Frame - 2 Module - Frosted Black	842	1/5/30
AC1202FB	Cover Plate + Frame - 3 Module - Frosted Black	902	1/20
AC1203FB	Cover Plate + Frame - 4 Module - Frosted Black	960	1/20
AC1205FB	Cover Plate + Frame - 6 Module - Frosted Black	1746	1/5/30
AC1207FB	Cover Plate + Frame - 8 Module - Frosted Black	1922	1/5/30
AC1208FB	Cover Plate + Frame - 2*4 Module - Frosted Black	2482	1/10
AC1210FB	Cover Plate + Frame - 2*6 Module - Frosted Black	2998	1/16
AC1136FB	Cover Plate - for Shaver Socket-3 Module - Frosted Black	1840	1/5/50

Brushed Stainless Steel Cover Plate with Support Frame

AC1200BS	Cover Plate + Frame - 1 Module - Brushed Stainless Steel	3596	1/5/30
AC1201BS	Cover Plate + Frame - 2 Module - Brushed Stainless Steel	3844	1/5/30
AC1202BS	Cover Plate + Frame - 3 Module - Brushed Stainless Steel	4134	1/20
AC1203BS	Cover Plate + Frame - 4 Module - Brushed Stainless Steel	4388	1/20

* MRP - Maximum Retail Price Inclusive of all taxes including GST.
Red Cat. Nos - New Products

Bold Cat.Nos are products normally available with Legrand (India) Stockists. Cat.Nos that are not bold - delivery within 4 - 8 weeks from the date of order. Bold packing quantity is our mandatory packing. Orders to be placed by Legrand (India) Stockist in multiples of the same.

Arteor Advance™

NEW! Classic- Cover Plate with Support Frame

Cat.Nos	Description	MRP* ₹ / Unit	Pack
AC1205BS	Cover Plate + Frame - 6 Module - Brushed Stainless Steel	7986	1/5/30
AC1207BS	Cover Plate + Frame - 8 Module - Brushed Stainless Steel	8782	1/5/30
AC1208BS	Cover Plate + Frame - 2*4 Module - Brushed Stainless Steel	11100	1/10
AC1210BS	Cover Plate + Frame - 2*6 Module - Brushed Stainless Steel	13682	1/16
AC1136BS	Cover Plate - for Shaver Socket-3 Module - Brushed Stainless Steel	4098	1/5/50

Solid Aluminium Cover Plate with Support Frame

AC1200SA	Cover Plate + Frame - 1 Module - Solid Aluminium	5134	1/5/30
AC1201SA	Cover Plate + Frame - 2 Module - Solid Aluminium	5494	1/5/30
AC1202SA	Cover Plate + Frame - 3 Module - Solid Aluminium	5908	1/20
AC1203SA	Cover Plate + Frame - 4 Module - Solid Aluminium	6270	1/20
AC1205SA	Cover Plate + Frame - 6 Module - Solid Aluminium	11408	1/5/30
AC1207SA	Cover Plate + Frame - 8 Module - Solid Aluminium	12544	1/5/30
AC1208SA	Cover Plate + Frame - 2*4 Module - Solid Aluminium	15856	1/10
AC1210SA	Cover Plate + Frame - 2*6 Module - Solid Aluminium	19546	1/16
AC1136SA	Cover Plate - for Shaver Socket-3 Module - Solid Aluminium	5854	1/5/50

Midnight Blue Cover Plate with Support Frame

AC1200NB	Cover Plate + Frame - 1 Module - Midnight Blue	5134	1/5/30
AC1201NB	Cover Plate + Frame - 2 Module - Midnight Blue	5494	1/5/30

Arteor Advance™

NEW! Elite- Cover Plate with Support Frame

Cat.Nos	Description	MRP* ₹ / Unit	Pack
Midnight Blue Cover Plate with Support Frame			
AC1202NB	Cover Plate + Frame - 3 Module - Midnight Blue	5908	1/20
AC1203NB	Cover Plate + Frame - 4 Module - Midnight Blue	6270	1/20
AC1205NB	Cover Plate + Frame - 6 Module - Midnight Blue	11408	1/5/30
AC1207NB	Cover Plate + Frame - 8 Module - Midnight Blue	12544	1/5/30
AC1208NB	Cover Plate + Frame - 2*4 Module - Midnight Blue	15856	1/10
AC1210NB	Cover Plate + Frame - 2*6 Module - Midnight Blue	19546	1/16
AC1136NB	Cover Plate - for Shaver Socket-3 Module - Midnight Blue	5854	1/5/50

Round Plates with Support Frame

AA1202MW	Cover Plate + Frame - 2 Module - Round - Matt White	658	10/100
AA1202MB	Cover Plate + Frame - 2 Module - Round - Matt Black	808	10/100
AA1202MT	Cover Plate + Frame - 2 Module - Round - Matt Titanium	808	10/100

Frosted White Cover Plate with Support Frame

AA1200FW	Cover Plate + Frame - 1 Module - 1 x Elite - Frosted White	984	1/5/30
AA1201FW	Cover Plate + Frame - 2 Module - 2 x Elite - Frosted White	1054	1/5/30
AA1202FW	Cover Plate + Frame - 2 Module - Round - Frosted White	1054	1/5/30
AA1203FW	Cover Plate + Frame - 3 Module - 3 x Elite - Frosted White	1130	1/20
AA1204FW**	Cover Plate + Frame - 4 Module - 4 x Elite - Frosted White	1248	1/5/30

* MRP - Maximum Retail Price Inclusive of all taxes including GST.
**Lead Time : 8 - 10 weeks after order booking
Red Cat. Nos - New Products

Bold Cat.Nos are products normally available with Legrand (India) Stockists.
Cat.Nos that are not bold - delivery within 4 - 8 weeks from the date of order.
Bold packing quantity is our mandatory packing. Orders to be placed by
Legrand (India) Stockist in multiples of the same.

Arteor Advance™

NEW! Elite- Cover Plate with Support Frame

Cat.Nos	Description	MRP* ₹ / Unit	Pack
AA1200FB	Cover Plate + Frame - 1 Module - 1 x Elite - Frosted Black	984	1/5/30
AA1201FB	Cover Plate + Frame - 2 Module - 2 x Elite - Frosted Black	1054	1/5/30
AA1202FB	Cover Plate + Frame - 2 Module - Round - Frosted Black	1054	1/5/30
AA1203FB	Cover Plate + Frame - 3 Module - 3 x Elite - Frosted Black	1130	1/20
AA1204FB**	Cover Plate + Frame - 4 Module - 4 x Elite - Frosted Black	1248	1/5/30

Brushed Stainless Steel Cover Plate with Support Frame

AA1200BS	Cover Plate + Frame - 1 Module - 1 x Elite - Brushed Stainless Steel	4492	1/5/30
AA1201BS	Cover Plate + Frame - 2 Module - 2 x Elite - Brushed Stainless Steel	4806	1/5/30
AA1202BS	Cover Plate + Frame - 2 Module - Round - Brushed Stainless Steel	4806	1/5/30
AA1203BS	Cover Plate + Frame - 3 Module - 3 x Elite - Brushed Stainless Steel	5170	1/20

Solid Aluminium Cover Plate with Support Frame

AA1200SA	Cover Plate + Frame - 1 Module - 1 x Elite - Solid Aluminium	6418	1/5/30
AA1201SA	Cover Plate + Frame - 2 Module - 2 x Elite - Solid Aluminium	6870	1/5/30
AA1202SA	Cover Plate + Frame - 2 Module - Round - Solid Aluminium	6870	1/5/30
AA1203SA	Cover Plate + Frame - 3 Module - 3 x Elite - Solid Aluminium	7386	1/20
AA1204SA**	Cover Plate + Frame - 4 Module - 4 x Elite - Solid Aluminium	8150	1/5/30

* MRP - Maximum Retail Price Inclusive of all taxes including GST.
**Lead Time : 8 - 10 weeks after order booking
Red Cat. Nos - New Products

Arteor Advance™

NEW! Hybrid(Classic+Elite)- Cover Plate with Support Frame

Cat.Nos	Description	MRP* ₹ / Unit	Pack
AA1200NB	Cover Plate + Frame - 1 Module - 1 x Elite - Midnight Blue	6418	1/5/30
AA1201NB	Cover Plate + Frame - 2 Module - 2 x Elite - Midnight Blue	6870	1/5/30
AA1202NB	Cover Plate + Frame - 2 Module - Round - Midnight Blue	6870	1/5/30
AA1203NB	Cover Plate + Frame - 3 Module - 3 x Elite - Midnight Blue	7386	1/20
AA1204NB**	Cover Plate + Frame - 4 Module - 4 x Elite - Midnight Blue	8150	1/5/30

Frosted White Cover Plate with Support Frame

AB1208FW	Cover Plate + Frame - 4 Module - 2 x Classic + 2 x Elite - Frosted White	1248	1/20
AB1203FW	Cover Plate + Frame - 6 Module - 3 x Classic + 2 x Elite - Frosted White	2270	1/5/30
AB1205FW	Cover Plate + Frame - 6 Module - 4 x Classic + 1 x Elite - Frosted White	2270	1/5/30
AB1202FW	Cover Plate + Frame - 6 Module - 3 x Classic + Round - Frosted White	2270	1/5/30
AB1207FW	Cover Plate + Frame - 8 Module - 5 x Classic + Round - Frosted White	2498	1/5/30

Frosted Black Cover Plate with Support Frame

AB1208FB	Cover Plate + Frame - 4 Module - 2 x Classic + 2 x Elite - Frosted Black	1248	1/20
AB1203FB	Cover Plate + Frame - 6 Module - 3 x Classic + 2 x Elite - Frosted Black	2270	1/5/30
AB1205FB	Cover Plate + Frame - 6 Module - 4 x Classic + 1 x Elite - Frosted Black	2270	1/5/30
AB1202FB	Cover Plate + Frame - 6 Module - 3 x Classic + Round - Frosted Black	2270	1/5/30
AB1207FB	Cover Plate + Frame - 8 Module - 5 x Classic + Round - Frosted Black	2498	1/5/30

Bold Cat.Nos are products normally available with Legrand (India) Stockists.
Cat.Nos that are not bold - delivery within 4 - 8 weeks from the date of order.
Bold packing quantity is our mandatory packing. Orders to be placed by
Legrand (India) Stockist in multiples of the same.

Arteor Advance™

Hybrid(Classic+Elite)- Cover Plate with Support Frame

NEW!

Cat.Nos	Description	MRP* ₹ / Unit	Pack
Brushed Stainless Steel Cover Plate with Support Frame			
AB1208BS	Cover Plate + Frame - 4 Module - 2 x Classic + 2 x Elite - Brushed Stainless Steel	5704	1/20
AB1203BS	Cover Plate + Frame - 6 Module - 3 x Classic + 2 x Elite - Brushed Stainless Steel	10382	1/5/30
AB1205BS	Cover Plate + Frame - 6 Module - 4 x Classic + 1 x Elite - Brushed Stainless Steel	10382	1/5/30
AB1202BS	Cover Plate + Frame - 6 Module - 3 x Classic + Round - Brushed Stainless Steel	10382	1/5/30
AB1207BS	Cover Plate + Frame - 8 Module - 5 x Classic + Round - Brushed Stainless Steel	11418	1/5/30



AB1205BS



AB1202BS



AB1207BS

Solid Aluminium Cover Plate with Support Frame

AB1208SA	Cover Plate + Frame - 4 Module - 2 x Classic + 2 x Elite - Solid Aluminium	8150	1/20
AB1203SA	Cover Plate + Frame - 6 Module - 3 x Classic + 2 x Elite - Solid Aluminium	14832	1/5/30
AB1205SA	Cover Plate + Frame - 6 Module - 4 x Classic + 1 x Elite - Solid Aluminium	14832	1/5/30
AB1202SA	Cover Plate + Frame - 6 Module - 3 x Classic + Round - Solid Aluminium	14832	1/5/30
AB1207SA	Cover Plate + Frame - 8 Module - 5 x Classic + Round - Solid Aluminium	16306	1/5/30



AB1208SA



AB1203SA



AB1202SA

Midnight Blue Cover Plate with Support Frame

AB1208NB	Cover Plate + Frame - 4 Module - 2 x Classic + 2 x Elite - Midnight Blue	8150	1/20
AB1203NB	Cover Plate + Frame - 6 Module - 3 x Classic + 2 x Elite - Midnight Blue	14832	1/5/30



AB1208NB



AB1205NB



AB1202NB



6890 07



6890 09



6890 10



6890 12

Arteor Advance™

Hybrid(Classic+Elite)- Cover Plate with Support Frame

NEW!

Cat.Nos	Description	MRP* ₹ / Unit	Pack
AB1205NB	Cover Plate + Frame - 6 Module - 4 x Classic + 1 x Elite - Midnight Blue	14832	1/5/30
AB1202NB	Cover Plate + Frame - 6 Module - 3 x Classic + Round - Midnight Blue	14832	1/5/30
AB1207NB	Cover Plate + Frame - 8 Module - 5 x Classic + Round - Midnight Blue	16306	1/5/30

Arteor Advance™







Accessories- Metal Flush Boxes

6890 07	Metal Flush Box - 1/2 Module	170	40
6890 08	Metal Flush Box - 3 Module	170	40
6890 09	Metal Flush Box - 4 Module	226	40
6890 10	Metal Flush Box - 6 Module	358	40
6890 42	Metal Flush Box - 8 Module	416	40
6890 31	Metal Flush Box - 4*2 Module	414	20
6890 29	Metal Flush Box - 9 Module	490	20
6890 11	Metal Flush Box -12 Module	624	10
6890 13	Metal Flush Box -16 Module	720	10
6890 12	Metal Flush Box - 18 Module	788	10

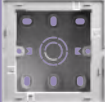
* MRP - Maximum Retail Price Inclusive of all taxes including GST.
Red Cat. Nos - New Products

Arteor Advance™

NEW! Accessories- Metal Flush Boxes

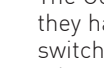
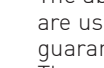
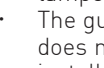
Cat.Nos	Description	MRP* ₹ / Unit	Pack
Surface Mounting Boxes			
 A1605WH	Plastic Surface Box - 1/2 Module	166	55
 A1606WH	Plastic Surface Box - 3 Module	202	42
 A1607WH	Plastic Surface Box - 4 Module	238	27
 A1608WH	Plastic Surface Box - 6 Module	298	20
 A1609WH	Plastic Surface Box - 8 Module	336	20
 A1611WH	Plastic Surface Box - 4*2 Module	410	10
 A1610WH	Plastic Surface Box - 9 Module	422	18
 A1612WH	Plastic Surface Box - 12 Module	1046	11
 A1614WH	Plastic Surface Box - 16 Module	1078	11
 A1613WH	Plastic Surface Box - 18 Module	1106	8

Arteor Advance™

Guarantee

- The Company, at its discretion, will replace products if they have any manufacturing defect within 10 years for switches (without LED lamp) and power sockets. For all other **Arteor Advance™** wiring accessories the guarantee will be 2 years.
- The above guarantee is applicable when the devices are used in Legrand metal flush boxes. Otherwise the guarantee period will be reduced by 50%.
- The guarantee is only applicable when the products are installed as per the Company's instructions and not tampered in any manner.
- The guarantee states the Company's entire liability. It does not extend to cover consequential loss or damage or installation costs arising from defective products.

Our switches are compliant with revised BIS standard (IS 3854:2023) requirements. Also, our switches are covered additionally for use on Self-Ballasted Lamp (SBL) loads.

SBL power rating as per IS3854:2023

Switch Rating	6A, 230V~	10A, 230V~	16A, 230V~	20A, 230V~
SBL power (Watt)	100 W	100 W	200 W	250 W

* MRP - Maximum Retail Price Inclusive of all taxes including GST.
Red Cat. Nos - New Products

ARTEOR™

Versatile Wiring Devices for Global Projects



Arteor™ is a modular wiring device range designed to meet the needs of residential, commercial, and hospitality projects worldwide. Combining ergonomic design, premium finishes, and advanced control options, it supports everything from standard electrical installations to connected IoT and BUS-based automation systems.

Features

- Ergonomic round and square rocker designs available in refined finishes
- Extensive finish palette with over 16 colours
- Extensive mechanism range with switches, dimmers, USB chargers, and data outlets
- Smart-ready solutions supporting automation, hotel controls, and scenario-based switching

Benefits

- Supports global projects with compliance to IEC & BS
- Enhances interiors with premium materials and contemporary design options
- Supports modern connectivity needs with integrated charging and data solutions
- Enables scalable control from simple wiring setups to advanced automation systems

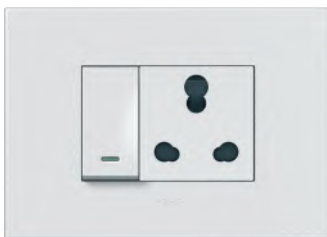

Scan to know more about the product.





Round rocker White



Round rocker Magnesium

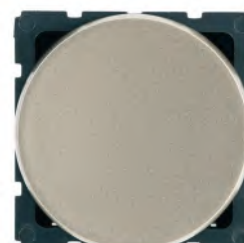

Round rocker Champagne



Square rocker White



Square rocker Magnesium



Square rocker Champagne



ARTEOR™

Versatility & Modularity for Unrivalled Flexibility

Arteor™ is a modular range offering maximum flexibility in terms of installation and configuration.

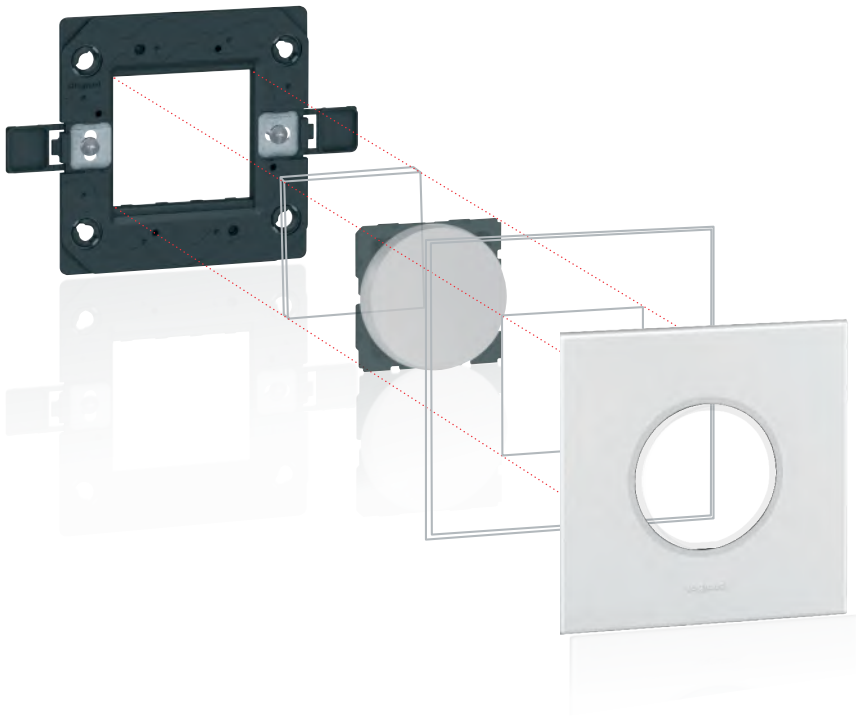

Features that set ARTEOR™ apart



- ① Finger-proof terminals for IP 20 protection against accidental contact.
- ② Captive "never to loose screws"

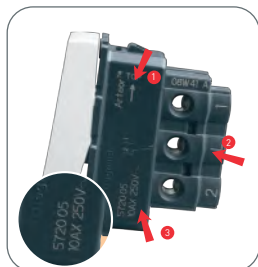

- ① Tunnel terminals preventing screwdrivers from slipping.
- ② Laser marking on mechanisms. Arrow showing the correct orientation of the mechanism.
- ③ The latest IS 3854 : 2023.



Sockets with ISI* mark, conforming to IS 1293. Fan regulator with ISI* mark, conforming to IS 11037.



Fully shrouded internal mechanism under the rocker preventing visibility of sparks.



- ① Stripping templates on sockets for stripping off exact length of insulation.

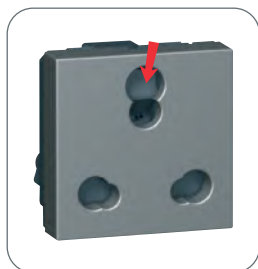

- ① Sockets are shuttered for child's safety against electric shocks.



Possibility of weather proofing mechanisms using Plexo IP 55 and IP 66 boxes.



For switches with LED lamps, life of LED is 50000 burning hours. Consumes power (0.76W) next to NIL.

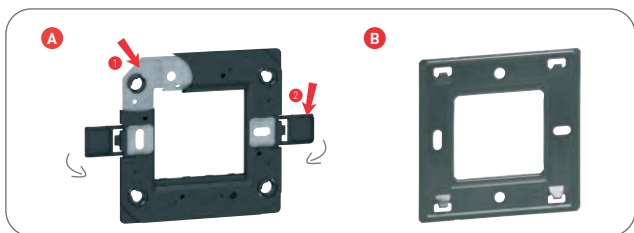

A. For all high end plates Metal frame providing solid support to base. Bi-material frame - electrical safety IP20. Screw caps can be closed once the support frame is installed, ensuring total insulation.



2x2 way switch - 3 controls possible in 2 module plate. In round and square design possible.

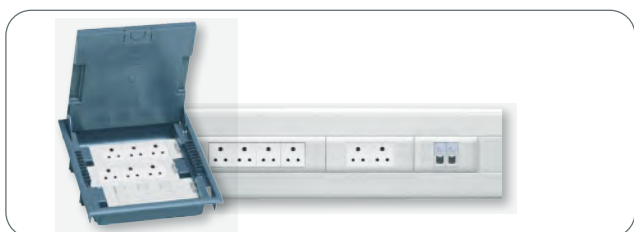

Mechanisms compatible with DLP trunking systems, columns, floor boxes and VDI installations.

ARTEOR™

The Ideal Solution, Always & Everywhere

Its versatility makes Arteor™ the ideal choice for every kind of project, anywhere in the world at any installation level. Arteor™ suits any requirement in terms of design and function for every kind of building, from residential to commercial.



TV socket



Skirting light



1-way switch - 3 gang



USB Charger
Type C+C - 65W





6AX switch*



Skirting light



USB charger
Type C+C - 30W



Triple RCA socket



Time delay switch

* Switch compatible with LED light

Modern Home



ARTEOR™

Office & Hotel Solutions

Offices and collective spaces require specific solutions and maximum flexibility: lighting adapted to each situation (meeting, conference, etc.), access security, comprehensive multimedia connections. The Arteor™ range meets all these expectations with perfect adaptability.



Automatic switch



6A 1 way switch



USB socket



Preterminated HDMI sockets



Female HD15 + Jack



USB Charger
Type C - 45W



From hotel room door to the beside table, Arteor™ provides all the solutions for the specific need of today's hotel industry. Comfort that extends to the hotel's communal areas, whether dedicated to the relaxation or work. The multitude of small details, gives the comfort feeling of being at home to the traveller.



Data sockets



4-Scenario touch control



S-Video socket



Keycard switch



External unit



Desk and Entrance Light



Bed light & curtain switch



Internal Unit

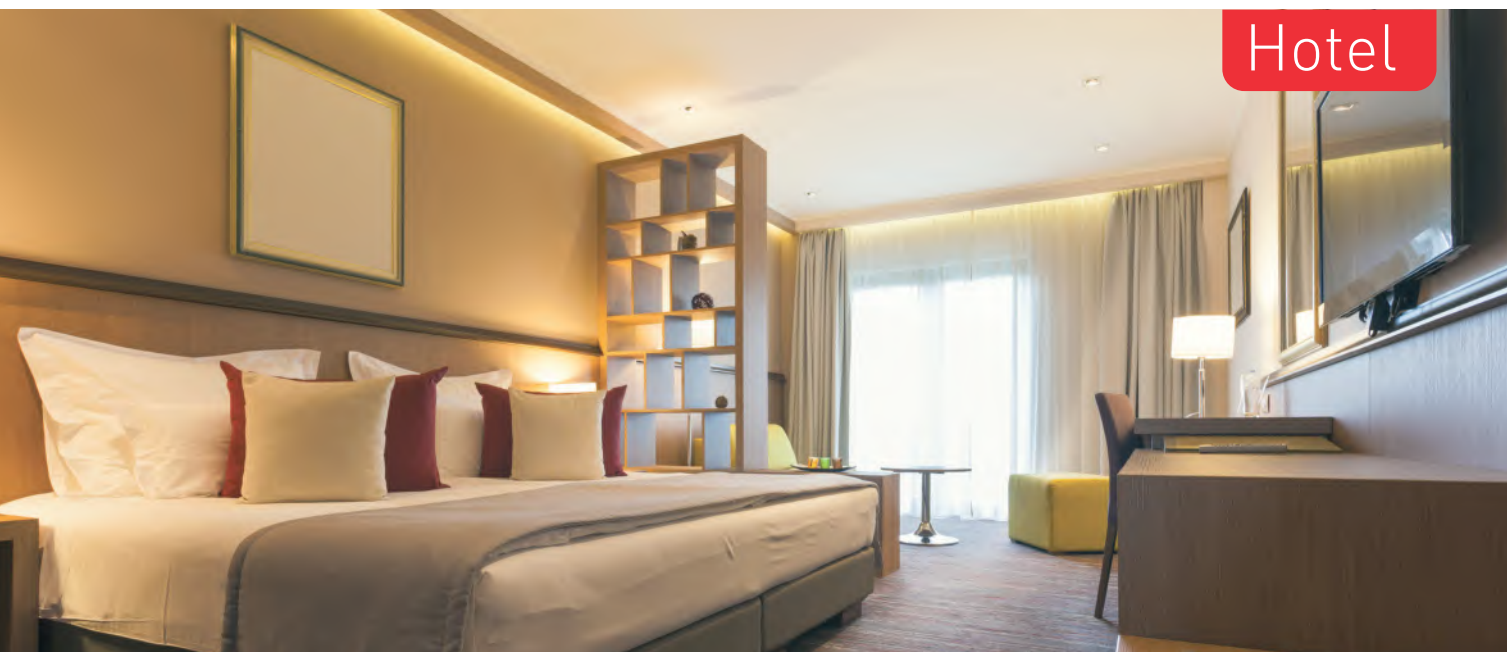

ARTEOR™

A Rich Choice of Finishes

NEUTRAL



MIRROR



GRAPHIC



METAL



Graphite



Dark Bronze



Green Apple



Dark Barque



SIGNATURE

Cube



ARTEOR™

MyHOME

Elegant and Intuitive Home Automation

Arteor™ MyHOME offers elegant home automation that combines beautiful design with simple touch control for lighting, blinds, HVAC, and more through intuitive touchscreens and smartphone apps.

Features

- Full-range touchscreen interface for home control
- Smartphone app with dedicated icons for lights, temperature, blinds, and scenarios
- Seamless integration across electrical, wiring, and building infrastructure
- Versatile design suitable for rural, industrial, and digital environments

Benefits

- Simplifies home management with intuitive touch and mobile control
- Enhances aesthetics while providing comprehensive automation
- Reduces complexity through unified interface for all systems
- Adapts to diverse architectural and lifestyle settings

Scan to know more about the product.



THE FINISHING TOUCH



Arteor™

Square White Mechanism

Cat.Nos	Description	MRP* ₹ / Unit	Pack
---------	-------------	------------------	------

Switches – 6A - 230V AC

5734 00	6A - Switch - SP - 1 Way - 1 Module	232	1/20/200
5734 01	6A - Switch - SP - 1 Way - with Indicator - 1 Module	432	1/20/200
5734 02	6A - Switch - SP - 2 Way - 1 Module	382	1/20/200
5734 03	6A - Switch - SP - 2 Way - with Indicator - 1 Module	540	1/20/200

Switches – 10A - 230V AC

5734 50	10A - Switch - SP - 1 Way - 2 Module	456	1/10/100
5734 51	10A - Switch - SP - 2 Way - 2 Module	538	1/10/100
5720 37	10A - Switch - SP - 2 Way - with Indicator & Label Holder - 2 Module	2552	5/50
5720 38	10A - Intermediate Switch - 230V AC - 2 Module	3054	10/100

Switches – 20A - 230V AC

5734 10	20A - Switch - SP - 1 Way - 1 Module	520	1/20/200
5734 52	20A - Switch - SP - 1 Way - 2 Module	620	1/10/100
5720 63	20A - Switch - SP - 1 Way - with Indicator - 1 Module	536	1/20/200
5734 11	20A - Switch - SP - 2 Way - with Indicator - 1 Module	750	1/20/200
5720 42	20A - Switch - SP - 2 Way - with Indicator - 2 Module	816	10/100
5720 43	20A - Switch - 3 Gang - 1 Way - 2 Module	1464	10/100
5720 44	20A - Switch - 3 Gang - 2*2 Way + 1*1 Way - 2 Module	1604	10/100
5734 54	20A - Switch - DP - 1 Way - with Indicator - 2 Module	1154	1/10/100
5720 49	20A - Switch - DP - 1 Way - with Indicator & Water Heater Marking - 2 Module	1210	10/100

Accessory for Switch with Indicator

5738 06	LED for Switch - with Indicator (Blue)	94	5/50
---------	--	----	------

Switches – 25A - 230V AC

5734 17	25A - Switch - 1 Way - with Indicator - 1 Module	696	1/20/200
---------	--	-----	----------

Arteor™

Square White Mechanism

Cat.Nos	Description	MRP* ₹ / Unit	Pack
---------	-------------	------------------	------

Switches – 32A / 40A - 230V AC

5734 12	32A - Switch - DP - 1 Way - with Indicator - 2 Module	1646	10/100
5735 30	40A - Switch - DP - 1 Way - with Indicator - fits on 1/2 Module Box	1896	1/5/20

Push Button – 6A - 230V AC

5734 13	6A - Bell Push - SP - 1 Way - 1 Module	418	1/20/200
5734 59	6A - Bell Push - SP - 1 Way - 2 Module	590	1/10/100
5734 04	6A - Push Button - SP - 1 Way - 1 Module	444	1/20/200
5734 05	6A - Push Button - SP - 1 Way - with Indicator - 1 Module	560	1/20/200
5734 14	6A - Bell Push - SP - 1 Way - with Indicator - 1 Module	556	1/20/200
5734 60	6A - Bell Push - SP - 1 Way - with Indicator - 2 Module	792	1/10/100

Electric Roller Blinds Control

5722 20	Double Switch for Electric Shutter - 2 Module	1024	1/10/100
---------	---	------	----------

Dimmers & Fan Regulators

5734 62	Light Dimmer - 60 to 400 Watts - 2 Module	1720	1/10/100
5734 16	Fan Step Regulator - 100 Watts - ISI - 1 Module	1416	1/5/50
5734 63	Fan Step Regulator - 100 Watts - ISI - 2 Module	1746	1/10/100
5734 69	Fan Step Regulator - 120 Watts - ISI - 2 Module (for 48 & 56" Fans)	1868	1/10/100
5734 68	Fan Step Regulator - for Energy Saving Fans - 2 Module	1864	1/10/100
5736 53	Fan Regulator - 8 Steps - 100 Watts - ISI - 2 Module	1666	1/10/100



5734 12



5734 13



5734 59



5734 05



5734 14



5722 20



5734 62



5734 63



5734 01



5734 50



5720 37



5734 10



5720 43



5720 49

* MRP - Maximum Retail Price Inclusive of all taxes including GST.

Bold Cat.Nos are products normally available with Legrand (India) Stockists. Cat.Nos that are not bold - delivery within 4 - 8 weeks from the date of order. Bold packing quantity is our mandatory packing. Orders to be placed by Legrand (India) Stockist in multiples of the same.

Arteor™

Square White Mechanism

Cat.Nos	Description	MRP* ₹ / Unit	Pack
---------	-------------	------------------	------

Indian Standard Sockets

5734 24	6A - Socket - with Shutter - 3 Pin - ISI - 2 Module	356	1/20/200
5734 71	6/16A - Socket - with Shutter - 3 Pin - Indian - ISI - 2 Module	722	1/20/200
5734 67	6/16A - Socket - with Shutter - 3 Pin - Indian - ISI - 3 Module	864	1/5/50
5735 10	16A - Socket Shutter with Switch - 3 Pin - 2P+E - Indian - 3 Module	2018	5/50

Energy Plugs

5738 86	6A - Plug	170	1/10/100
5738 88	16A - Plug	228	1/10/100

USB Chargers (IS13252 (Part 1) / IEC 60950-1)

5734 41	USB Charger - 1500mA - Type A - 1 Module	2722	1/5/50
5716 80	USB Charger - 3000mA/15 Watts - Type A - 1 Module	3206	1/10/150
5716 84	USB Charger - 3000mA/15 Watts - Type A + A - 1 Module	3626	1/10/150
5716 88	USB Charger - 3000mA/15 Watts - Type A + C - 1 Module	4040	1/10/150
5716 92	USB Charger - 3000mA/15 Watts - Type C + C - 1 Module	4526	1/10/150
5716 96	USB Charger - Power Delivery - 20 Watts - Type C - 1 Module	6194	1/10/150
5734 81	USB Charger - Power Delivery - 30 Watts - Type C + C - 2 Module	9268	1/20
5754 81	USB Charger - Power Delivery - 45 Watts - Type C - 2 Module	11962	1/20
NEW! 5754 94	USB Charger - Power Delivery - 65 Watts - Type C + C - 3 Module	14650	1/20

Data & Voice

5734 27	Telephone Socket - Double RJ11 - 1 Module	642	1/20/200
5734 26	Telephone Socket - RJ11 - with Shutter - 1 Module	374	1/20/200
5734 29	Information Socket - RJ45 - Cat 5E - UTP - 1 Module	739	1/20/200
5734 75	Information Socket - RJ45 - Cat 5E - UTP - 2 Module	788	1/10/100
5734 28	Information Socket - RJ45 - Cat 6 - UTP - 1 Module	1127	1/20/200
5734 74	Information Socket - RJ45 - Cat 6 - UTP - 2 Module	1184	1/10/100



5734 71



5738 88



5716 84



5716 88



5716 92



5734 81



5754 94



5734 26



5734 75



5734 28

Arteor™

Square White Mechanism

Cat.Nos	Description	MRP* ₹ / Unit	Pack
---------	-------------	------------------	------

Tv Sockets

5734 25	TV Co - axial Socket - 1 Module	390	1/20/200
---------	---------------------------------	-----	----------

Electronic Chime

5734 43	Bell Ding Dong - 230V - 2 Module	686	1/10/100
---------	----------------------------------	-----	----------

Buzzer

5734 42	Buzzer - 230V - 1 Module	1822	1/20/200
---------	--------------------------	------	----------

Bell Call Indicator & Register - 6A - 230V AC

5734 15	6A - Bell Call Indicator - SP - with Register - 1 Way - 1 Module	2646	1/20/200
5736 06	Set of Labels for Bell Call Indicator	704	1/5/50

Skirting Light

5734 64	Skirting Light - with LED - 230V - 3 Module	1420	1/10/100
5722 26	Skirting Light - with Detector (LED) - 230V - 2 Module	18570	1/20

Lighting

5724 53	Over Door Light Unit (Red) - 2 Module	798	10/100
5722 23	Over Door Light Unit (White) - 2 Module	656	10/100
NEW! 5735 97*	Indicator Unit - with Transparent LED - 1 Module	732	10/100

Hospitality Function

Hotel "DND & MMR" Functions

5734 61	External DND & MMR Control Unit - with Bell Push - 2 Module	2840	1/5/50
5734 58	Internal DND & MMR Control Unit - 2 Module	2036	1/10/100

Hotel Keycard Switch

5722 44	16A - Key Card Switch - 230V - 2 Module	7752	1/10
5722 59	Key Fob for Key Card Switch	2114	10/50

Shaver Socket

5721 53	Shaver Socket - 230V/120 - 230V - with Earth Connector	8056	1
---------	--	------	---



5734 25



5734 43



5734 15



5722 26



5724 53



5734 61



5722 44



5721 53

* MRP - Maximum Retail Price Inclusive of all taxes including GST.

^Coming Soon.

Red Cat. Nos - New Products

Bold Cat.Nos are products normally available with Legrand (India) Stockists. Cat.Nos that are not bold - delivery within 4 - 8 weeks from the date of order. Bold packing quantity is our mandatory packing. Orders to be placed by Legrand (India) Stockist in multiples of the same.

Arteor™

Square White Mechanism

Cat.Nos	Description	MRP* ₹ / Unit	Pack
---------	-------------	------------------	------

Time Switch

5720 55	Time Delay Switch - 2 Module	9554	1/20
---------	------------------------------	------	------

Audio-Video Sockets

5722 72	Double RCA Socket (Audio) - 1 Module	6074	1/20
5722 73	Triple RCA Socket (Audio & Video) - 1 Module	5448	1/20
5722 74	Female 3.5mm Jack - 1 Module	6043	1/20
5722 76	Female BNC 75 Jack - 1 Module	6375	1/20
5722 83	Female XLR Jack - 2 Module	9372	1/20
5720 97	Preterminated Sockets Female Hd15 - 1 Module	8413	1
5720 96	Preterminated HDMI Socket - 1.4 - 1 Module	9980	1
5722 84	Line Dying Down - 100V (25 - 30W) - 2 Module	15612	1
5722 77	Male XLR Jack - 2 Module	8575	1/20
5722 78	Female 3.5mm Jack - Solder - 1 Module	4985	1/20
5722 75	USB Socket - 1 Module	4695	1/20
5722 88	Female HD15 + Jack 3.5mm - 2 Module	6773	1/20

Cable Outlet

5734 80	45A - Cable Outlet - 2 Module	1560	5/50
5734 33	Cord Outlet - with 8mm Diameter - 1 Module	494	1/20/200
5734 79	Standard Cord Outlet - 2 Module	714	10/100

Blanking Plate

5734 49	Blanking Plate - 1 Module	72	1/40/400
5723 44	Blanking Plate - 2 Module	108	1/10/100
5758 10	Blanking Plate with Frame - 2 Module	656	10/100

Mounting Accessories for Panel

5760 15	Panel Mounting Support - 1 Module	414	1/10/100
5760 16	Panel Mounting Support - 2 Module	440	1/10/100
5760 50	DIN Rail Support - 2 Module	522	1/10/100

Square - Magnesium Mechanism

Switches – 6A - 230V AC

5736 00	6A - Switch - SP - 1 Way - 1 Module	272	1/20/200
5736 01	6A - Switch - SP - 1 Way - with Indicator - 1 Module	492	1/20/200

Arteor™

Square Magnesium Mechanism

Cat.Nos	Description	MRP* ₹ / Unit	Pack
---------	-------------	------------------	------

Switches – 6A - 230V AC

5736 02	6A - Switch - SP - 2 Way - 1 Module	444	1/20/200
5736 03	6A - Switch - SP - 2 Way - with Indicator - 1 Module	630	1/20/200

Switches – 10A - 230V AC

5736 50	10A - Switch - SP - 1 Way - 2 Module	488	1/10/100
5736 51	10A - Switch - SP - 2 Way - 2 Module	574	1/10/100
5725 37	10A - Switch - SP - 2 Way - with Indicator & Label Holder - 2 Module	2876	1/5/50
5725 38	10A - Intermediate Switch - 230V AC - 2 Module	3516	1/10/100

Switches – 20A - 230V AC

5736 10	20A - Switch - SP - 1 Way - 1 Module	590	1/20/200
5736 52	20A - Switch - SP - 1 Way - 2 Module	694	1/10/100
5725 63	20A - Switch - SP - 1 Way - with Indicator - 1 Module	620	1/20/200
5736 11	20A - Switch - SP - 2 Way - with Indicator - 1 Module	850	1/20/200
5725 42	20A - Switch - SP - 2 Way - with Indicator - 2 Module	910	1/5/50
5725 43	20A - Switch - 3 Gang - 1 Way - 2 Module	1682	1/10/100
5725 44	20A - Switch - 3 Gang - 2*2 Way + 1*1 Way - 2 Module	1756	1/10/100
5736 54	20A - Switch - DP - 1 Way - with Indicator - 2 Module	1360	1/10/100
5725 49	20A - Switch - DP - 1 Way - with Indicator & Water Heater Marking - 2 Module	1452	1/10/100

Switches – 25A - 230V AC

5736 17	25A - Switch - 1 Way - with Indicator - 1 Module	782	1/20/200
---------	--	-----	----------

Switches – 32A - 230V AC

5736 12	32A - Switch - DP - 1 Way - with Indicator - 2 Module	1896	1/10/100
---------	---	------	----------

Push Button – 6A - 230V AC

5736 13	6A - Bell Push - SP - 1 Way - 1 Module	472	1/20/200
5736 59	6A - Bell Push - SP - 1 Way - 2 Module	674	1/10/100
5736 04	6A - Push Button - SP - 1 Way - 1 Module	490	1/20/200
5736 05	6A - Push Button - SP - 1 Way - with Indicator - 1 Module	654	1/20/200

* MRP - Maximum Retail Price Inclusive of all taxes including GST.

Bold Cat.Nos are products normally available with Legrand (India) Stockists. Cat.Nos that are not bold - delivery within 4 - 8 weeks from the date of order. Bold packing quantity is our mandatory packing. Orders to be placed by Legrand (India) Stockist in multiples of the same.

Arteor™

Square Magnesium Mechanism

Cat.Nos	Description	MRP* ₹ / Unit	Pack
---------	-------------	------------------	------

Push Button – 6A - 230V AC

5736 14	6A - Bell Push - SP - 1 Way - with Indicator - 1 Module	650	1/20/200
5736 60	6A - Bell Push - SP - 1 Way - with Indicator - 2 Module	908	1/10/100

Electric Roller Blinds Control

5727 20	Double Switch for Electric Shutter - 2 Module	1190	1/10/100
---------	---	------	----------

Dimmers & Fan Regulators

5736 62	Light Dimmer - 60 to 400 Watts - 2 Module	1986	1/10/100
5736 16	Fan Step Regulator - 100 Watts - ISI - 1 Module	1632	1/5/50
5736 63	Fan Step Regulator - 100 Watts - ISI - 2 Module	2012	1/10/100
5736 69	Fan Step Regulator - 120 Watts - ISI - 2 Module (for 48 & 56" Fans)	2154	1/10/100
5736 68	Fan Step Regulator - for Energy Saving Fans - 2 Module	2136	1/10/100
5736 56	Fan Regulator - 8 Steps - 100 Watts - ISI - 2 Module	1910	1/10/100

Indian Standard Sockets

5736 24	6A - Socket - with Shutter - 3 Pin - ISI - 2 Module	420	1/20/200
5736 71	6/16A - Socket - with Shutter - 3 Pin - Indian - ISI - 2 Module	824	1/20/200
5736 67	6/16A - Socket - with Shutter - 3 Pin - Indian - ISI - 3 Module	1004	1/5/50
5737 10	16A - Socket Shutter with Switch - 3 Pin - 2P+E - Indian - 3 Module	2320	5/50

USB Chargers (IS13252 (Part 1) / IEC 60950-1)

5734 44	USB Charger - 1500mA - Type A - 1 Module	3140	1/5/50
5716 81	USB Charger - 3000mA/15 Watts - Type A - 1 Module	3532	1/10/150

Arteor™

Square Magnesium Mechanism

Cat.Nos	Description	MRP* ₹ / Unit	Pack
---------	-------------	------------------	------

USB Chargers (IS13252 (Part 1) / IEC 60950-1)

5716 85	USB Charger - 3000mA/15 Watts - Type A + A - 1 Module	4028	1/10/150
5716 89	USB Charger - 3000mA/15 Watts - Type A + C - 1 Module	4620	1/10/150
5716 93	USB Charger - 3000mA/15 Watts - Type C + C - 1 Module	5048	1/10/150
5716 97	USB Charger - Power Delivery - 20 Watts - Type C - 1 Module	6638	1/10/150
5734 82	USB Charger - Power Delivery - 30 Watts - Type C + C - 2 Module	9698	1/20
5754 82	USB Charger - Power Delivery - 45 Watts - Type C - 2 Module	12514	1/20
NEW! 5754 95	USB Charger - Power Delivery - 65 Watts - Type C + C - 3 Module	15328	1/20

Data & Voice

5736 27	Telephone Socket - Double RJ11 - 1 Module	742	1/20/200
5736 26	Telephone Socket - RJ11 - with Shutter - 1 Module	448	1/20/200
5736 29	Information Socket - RJ45 - Cat 5E - UTP - 1 Module	846	1/20/200
5736 28	Information Socket - RJ45 - Cat 6 - UTP - 1 Module	1290	1/20/200
5736 74	Information Socket - RJ45 - Cat 6 - UTP - 2 Module	1360	1/10/100

TV Sockets

5736 25	TV Co - axial Socket - 1 Module	460	1/20/200
---------	---------------------------------	-----	----------

Electronic Chime

5736 43	Bell Ding Dong - 230V - 2 Module	736	1/10/100
---------	----------------------------------	-----	----------

Buzzer

5736 42	Buzzer - 230V - 1 Module	1994	1/20/200
---------	--------------------------	------	----------

Bell Call Indicator & Register - 6A - 230V AC

5736 15	6A - Bell Call Indicator - SP - with Register - 1 Way - 1 Module	3042	1/20/200
---------	--	------	----------

* MRP - Maximum Retail Price Inclusive of all taxes including GST.
Red Cat. Nos - New Products

Bold Cat.Nos are products normally available with Legrand (India) Stockists. Cat.Nos that are not bold - delivery within 4 - 8 weeks from the date of order. Bold packing quantity is our mandatory packing. Orders to be placed by Legrand (India) Stockist in multiples of the same.

Arteor™

Square Magnesium Mechanism

Cat.Nos	Description	MRP* ₹ / Unit	Pack
---------	-------------	------------------	------

Lighting

5735 64	Skirting Light - with LED - 230V - 3 Module	1638	1/10/100
5727 26	Skirting Light - with Detector (LED) - 230V - 2 Module	21352	1/20

Hospitality Function

Hotel "DND and MMR " functions

5736 61	External DND & MMR Control Unit - with Bell Push - 2 Module	3250	1/5/50
5736 58	Internal DND & MMR Control Unit - 2 Module	2352	1/10/100

Hotel Keycard Switch

5727 44	16A - Key Card Switch - 230V - with Time Delay - 2 Module	8532	1/10
5727 59	Key Fob for Key Card Switch	2934	10/50

Shaver Socket

5726 53	Shaver Socket - 230V/120 - 230V - with Earth Connector	8870	1
---------	--	------	---

Time Switch

5740 84	Time Delay Switch - 2 Module	10574	1/20
---------	------------------------------	-------	------

Audio - Video Connector

5727 72	Double RCA Socket (Audio) - 1 Module	7564	1/20
5727 73	Triple RCA Socket (Audio & Video) - 1 Module	5901	1/20
5727 74	Female 3.5mm Jack - 1 Module	6712	1/20
5727 76	Female BNC 75 Jack - 1 Module	6528	1/20
5727 83	Female XLR Jack - 2 Module	11737	1/20
5725 97	Preterminated Sockets Female Hd15 - 1 Module	9255	1
5725 96	Preterminated HDMI Socket - 1.4 - 1 Module	10494	1
5727 84	Line Dying Down - 100V (25 - 30W) - 2 Module	18788	1

Arteor™

Square Magnesium Mechanism

Cat.Nos	Description	MRP* ₹ / Unit	Pack
---------	-------------	------------------	------

Audio - Video Connector

5727 75	USB Socket - 1 Module	5245	1/20
5727 88	Female HD15 + Jack 3.5mm - 2 Module	7365	1/20

Blanking Plate

5736 49	Blanking Plate - 1 Module	70	1/40/400
5728 44	Blanking Plate - 2 Module	122	1/10/100

Dedicated Switches

5738 02	20A - Dedicated Switch - DP - 1 Way - 1 Module - Red	1366	1/10/100
---------	--	------	----------

Tamper Proof & Dedicated Sockets

5738 10	16A - Dedicated Socket with Switch - 3 Pin - 2P+E - Indian - 3 Module	2842	1/10/100
---------	---	------	----------

Square - Champagne Mechanism

Switches – 6A - 230V AC

5748 00	6A - Switch - SP - 1 Way - 1 Module	272	1/20/200
5748 01	6A - Switch - SP - 1 Way - with Indicator - 1 Module	492	1/20/200
5748 02	6A - Switch - SP - 2 Way - 1 Module	444	1/20/200
5748 03	6A - Switch - SP - 2 Way - with Indicator - 1 Module	630	1/20/200

Switches – 10A - 230V AC

5748 04	10A - Switch - SP - 1 Way - 2 Module	488	1/10/100
5748 05	10A - Switch - SP - 2 Way - 2 Module	574	1/10/100
5748 06	10A - Switch - SP - 2 Way - with Indicator & Label Holder - 2 Module	2876	1/10/100
5748 07	10A - Intermediate Switch - 230V AC - 2 Module	3516	1/10/100

Switches – 20A - 230V AC

5748 08	20A - Switch - SP - 1 Way - 1 Module	590	1/20/200
5748 09	20A - Switch - SP - 1 Way - 2 Module	694	1/10/100
5748 10	20A - Switch - SP - 1 Way - with Indicator - 1 Module	620	1/20/200
5748 11	20A - Switch - SP - 2 Way - with Indicator - 1 Module	850	1/20/200

* MRP - Maximum Retail Price Inclusive of all taxes including GST.

Bold Cat.Nos are products normally available with Legrand (India) Stockists. **Cat.Nos** that are not bold - delivery within 4 - 8 weeks from the date of order. **Bold packing quantity** is our mandatory packing. Orders to be placed by Legrand (India) Stockist in multiples of the same.

Arteor™

Square Champagne Mechanism

Cat.Nos	Description	MRP* ₹ / Unit	Pack
---------	-------------	------------------	------

Switches – 20A - 230V AC

5748 12	20A - Switch - SP - 2 Way - with Indicator - 2 Module	910	1/10/100
5748 13	20A - Switch - 3 Gang - 1 Way - 2 Module	1680	1/10/100
5748 14	20A - Switch - 3 Gang - 2*2 Way + 1*1 Way - 2 Module	1756	1/10/100
5748 15	20A - Switch - DP - 1 Way - with Indicator - 2 Module	1360	1/10/100
5748 16	20A - Switch - DP - 1 Way - with Indicator & Water Heater Marking - 2 Module	1452	1/10/100

Switches – 25A - 230V AC

5748 17	25A - Switch - 1 Way - with Indicator - 1 Module	782	1/20/200
---------	--	-----	----------

Switches – 32A / 40A - 230V AC

5748 18	32A - Switch - DP - 1 Way - with Indicator - 2 Module	1896	1/10/100
5748 19	40A - Switch - DP - 1 Way - with Indicator - fits on 1/2 Module Box	2180	1/5/20

Push Button – 6A - 230V AC

5748 23	6A - Bell Push - SP - 1 Way - 1 Module	472	1/20/200
5748 24	6A - Bell Push - SP - 1 Way - 2 Module	674	1/10/100
5748 21	6A - Push Button - SP - 1 Way - 1 Module	490	1/20/200
5748 22	6A - Push Button - SP - 1 Way - with Indicator - 1 Module	654	1/20/200
5748 25	6A - Bell Push - SP - 1 Way - with Indicator - 1 Module	650	1/20/200
5748 26	6A - Bell Push - SP - 1 Way - with Indicator - 2 Module	908	1/10/100

Electric Roller Blinds Control

5748 20	Double Switch for Electric Shutter - 2 Module	1190	1/10/100
---------	---	------	----------

Dimmers & Fan Regulators

5748 27	Light Dimmer - 60 to 400 Watts - 2 Module	2042	10/100
5748 29	Fan Step Regulator - 100 Watts - ISI - 1 Module	1632	1/5/50
5748 30	Fan Step Regulator - 100 Watts - ISI - 2 Module	2012	1/10/100
5748 31	Fan Step Regulator - 120 Watts - ISI - 2 Module (for 48 & 56" Fans)	2154	1/10/100
5748 32	Fan Step Regulator - for Energy Saving Fans - 2 Module	2136	1/10/100

Arteor™

Square Champagne Mechanism

Cat.Nos	Description	MRP* ₹ / Unit	Pack
---------	-------------	------------------	------

5736 57	Fan Regulator - 8 Steps - 100 Watts - ISI - 2 Module	1910	1/10/100
---------	--	------	----------

Indian Standard Sockets

5748 84	6A - Socket - with Shutter - 3 Pin - ISI - 2 Module	420	1/20/200
5748 34	6/16A - Socket - with Shutter - 3 Pin - Indian - ISI - 2 Module	824	1/20/200
5748 35	6/16A - Socket - with Shutter - 3 Pin - Indian - ISI - 3 Module	1004	1/5/50

USB Chargers (IS13252 (part 1) / IEC 60950-1)

5734 47	USB Charger - 1500mA - Type A - 1 Module	3140	1/5/50
5716 82	USB Charger - 3000mA/15 Watts - Type A - 1 Module	3532	1/10/150
5716 86	USB Charger - 3000mA/15 Watts - Type A + A - 1 Module	4028	1/10/150
5716 90	USB Charger - 3000mA/15 Watts - Type A + C - 1 Module	4620	1/10/150
5716 94	USB Charger - 3000mA/15 Watts - Type C + C - 1 Module	5048	1/10/150
5716 98	USB Charger - Power Delivery - 20 Watts - Type C - 1 Module	6638	1/10/150
5734 83	USB Charger - Power Delivery - 30 Watts - Type C + C - 2 Module	9698	1/20
5754 83	USB Charger - Power Delivery - 45 Watts - Type C - 2 Module	12514	1/20
5754 96	USB Charger - Power Delivery - 65 Watts - Type C + C - 3 Module	15328	1/20

Data & Voice

5748 45	Telephone Socket - Double RJ11 - 1 Module	742	1/20/200
5748 46	Telephone Socket - RJ11 - with Shutter - 1 Module	448	1/20/200
5748 47	Information Socket - RJ45 - Cat 5E - UTP - 1 Module	846	1/20/200
5748 48	Information Socket - RJ45 - Cat 5E - UTP - 2 Module	909	1/10/100
5748 49	Information Socket - RJ45 - Cat 6 - UTP - 1 Module	1290	1/20/200
5748 50	Information Socket - RJ45 - Cat 6 - UTP - 2 Module	1360	1/10/100

TV Sockets

5748 51	TV Co - axial Socket - 1 Module	460	1/20/200
---------	---------------------------------	-----	----------

Electronic Chime

5748 52	Bell Ding Dong - 230V - 2 Module	736	1/10/100
---------	----------------------------------	-----	----------

* MRP - Maximum Retail Price Inclusive of all taxes including GST.
Red Cat. Nos - New Products

Bold Cat.Nos are products normally available with Legrand (India) Stockists. Cat.Nos that are not bold - delivery within 4 - 8 weeks from the date of order. Bold packing quantity is our mandatory packing. Orders to be placed by Legrand (India) Stockist in multiples of the same.

Arteor™

Square Champagne Mechanism

Cat.Nos	Description	MRP* ₹ / Unit	Pack
---------	-------------	------------------	------

Buzzer

5748 53	Buzzer - 230V - 1 Module	1994	1/20/200
---------	--------------------------	------	----------

Bell Call Indicator & Register - 6A - 230V AC

5748 54	6A - Bell Call Indicator - SP - with Register - 1 Way - 1 Module	3042	1/20/200
---------	--	------	----------

Lighting

5748 55	Skirting Light - with LED - 230V - 3 Module	1638	1/10/100
---------	---	------	----------

Hospitality Function

Hotel "DND and MMR" Functions

5748 56	External DND & MMR Control Unit - with Bell Push - 2 Module	3250	1/5/50
5748 57	Internal DND & MMR Control Unit - 2 Module	2352	1/10/100

Hotel Keycard Switch

5748 58	16A - Key Card Switch - 230V - with Time Delay - 2 Module	8410	1/0/10
5727 59	Key Fob for Key Card Switch	2934	10/50

Blanking Plate

5748 63	Blanking Plate - 1 Module	70	1/40/400
5748 64	Blanking Plate - 2 Module	122	1/10/100

Round - White Mechanism

Switches - 6A - 230V AC

5733 00	6A - Switch - SP - 1 Way - Left - 1 Module	346	1/20/200
5733 01	6A - Switch - SP - 1 Way - Right - 1 Module	346	1/20/200
5733 12	6A - Switch - SP - 1 Way - Middle - 1 Module	346	1/20/200
5733 05	6A - Switch - SP - 2 Way - Left - 1 Module	458	1/20/200
5733 06	6A - Switch - SP - 2 Way - Right - 1 Module	458	1/20/200
5733 02	6A - Switch - SP - 1 Way - with Indicator - Left - 1 Module	522	1/20/200
5733 04	6A - Switch - SP - 1 Way - with Indicator - Right - 1 Module	522	1/20/200

Arteor™

Round White Mechanism

Cat.Nos	Description	MRP* ₹ / Unit	Pack
---------	-------------	------------------	------

Switches - 6A - 230V AC

5733 03	6A - Switch - SP - 1 Way - with Indicator - Middle - 1 Module	522	1/20/200
5733 07	6A - Switch - SP - 2 Way - with Indicator - Left - 1 Module	652	1/20/200
5733 08	6A - Switch - SP - 2 Way - with Indicator - Right - 1 Module	652	1/20/200

Switches - 20A - 230V AC

5733 20	20A - Switch - SP - 1 Way - Left - 1 Module	626	1/20/200
5733 21	20A - Switch - SP - 1 Way - Right - 1 Module	626	1/20/200
5730 21	20A - Switch - SP - 1 Way - Middle - 1 Module	642	1/10/100
5733 40	20A - Switch - SP - 1 Way - 2 Module	732	1/10/100
5720 64	20A - Switch - SP - 1 Way - with Indicator - Left - 1 Module	648	1/20/200
5720 65	20A - Switch - SP - 1 Way - with Indicator - Right - 1 Module	648	1/20/200
5730 24	20A - Switch - SP - 2 Way - Middle - 1 Module	650	1/10/100
5733 22	20A - Switch - SP - 2 Way - with Indicator - Left - 1 Module	896	1/20/200
5733 23	20A - Switch - SP - 2 Way - with Indicator - Right - 1 Module	896	1/20/200
5730 71	20A - Switch - SP - 2 Way - with Indicator - 2 Module	798	1/5/50
5730 72	20A - Switch - 3 Gang - 1 Way - 2 Module	1754	1/10/100
5730 73	20A - Switch - 3 Gang - 2*2 Way + 1*1 Way - 2 Module	1932	1/10/100
5733 42	20A - Switch - DP - 1 Way - with Indicator - 2 Module	1360	1/10/100

Switches - 32A - 230V AC

5733 26	32A - Switch - DP - 1 Way - with Indicator - 2 Module	1982	1/10/100
---------	---	------	----------

Push Button - 6A - 230V AC

5733 31	6A - Bell Push - SP - 1 Way - Right - 1 Module	490	1/20/200
5733 30	6A - Bell Push - SP - 1 Way - Left - 1 Module	490	1/20/200
5733 46	6A - Bell Push - SP - 1 Way - 2 Module	696	1/10/100
5733 47	6A - Bell Push - SP - 1 Way - with Indicator - 2 Module	946	1/10/100

Electronic Roller Blinds Control

5732 20	Double Switch For Electric Shutter - 2 Module	1240	1/10/100
---------	---	------	----------

* MRP - Maximum Retail Price Inclusive of all taxes including GST.

Bold Cat.Nos are products normally available with Legrand (India) Stockists. Cat.Nos that are not bold - delivery within 4 - 8 weeks from the date of order. Bold packing quantity is our mandatory packing. Orders to be placed by Legrand (India) Stockist in multiples of the same.

Arteor™

Round White Mechanism



5730 66

Cat.Nos	Description	MRP* ₹ / Unit	Pack
---------	-------------	------------------	------

Dimmers & Fan Regulators

5730 66	Light Dimmer - 60 to 400 Watts - 2 Module	2068	1/10/100
5730 03	Fan Step Regulator - 100 Watts - ISI - 2 Module	2096	1/10/100
5730 69	Fan Step Regulator - 120 Watts - ISI - 2 Module	2272	1/10/100
5730 04	Fan Step Regulator - for Energy Saving Fans - 2 Module	2224	1/10/100

Indian Standard Sockets

5734 94	6A - Socket - with Shutter - 3 Pin - ISI - 2 Module	748	1/20/200
---------	---	-----	----------



5723 24

Data & Voice

5723 24	Information Socket - RJ45 - Cat 6 - UTP - 2 Module	1513	10/100
---------	--	------	--------



5720 74

Hotel "DND & MMR" Functions

5720 74	Internal DND & MMR Control Unit - 2 Module	2848	1/5/50
5720 67	External DND & MMR Control Unit - with Bell Push - 2 Module	3578	5/40



5730 87

Blanking Plate

5730 87	Blanking Plate - 2 Module	124	1/10/100
---------	---------------------------	-----	----------

Round - Magnesium Mechanism

Switches - 6A - 230V AC

5733 50	6A - Switch - SP - 1 Way - Left - 1 Module	400	1/20/200
5733 51	6A - Switch - SP - 1 Way - Right - 1 Module	400	1/20/200
5733 62	6A - Switch - SP - 1 Way - Middle - 1 Module	402	1/20/200
5733 55	6A - Switch - SP - 2 Way - Left - 1 Module	528	1/20/200
5733 56	6A - Switch - SP - 2 Way - Right - 1 Module	528	1/20/200
5733 52	6A - Switch - SP - 1 Way - with Indicator - Left - 1 Module	586	1/20/200

5733 50

5733 51

5733 62

Arteor™

Round Magnesium Mechanism



5733 70



5733 71



5733 72



5733 92



5733 76

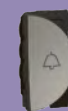

5733 81



5733 80

Cat.Nos	Description	MRP* ₹ / Unit	Pack
---------	-------------	------------------	------

Switches - 6A - 230V AC

5733 54	6A - Switch - SP - 1 Way - with Indicator - Right - 1 Module	586	1/20/200
5733 57	6A - Switch - SP - 2 Way - with Indicator - Left - 1 Module	756	1/20/200
5733 58	6A - Switch - SP - 2 Way - with Indicator - Right - 1 Module	756	1/20/200

Switches - 20A - 230V AC

5733 70	20A - Switch - SP - 1 Way - Left - 1 Module	698	1/20/200
5733 71	20A - Switch - SP - 1 Way - Right - 1 Module	698	1/20/200
5731 21	20A - Switch - SP - 1 Way - Middle - 1 Module	698	1/10/100
5733 90	20A - Switch - SP - 1 Way - 2 Module	830	1/10/100
5725 64	20A - Switch - SP - 1 Way - with Indicator - Left - 1 Module	732	1/20/200
5725 65	20A - Switch - SP - 1 Way - with Indicator - Right - 1 Module	732	1/20/200
5731 24	20A - Switch - SP - 2 Way - Middle - 1 Module	744	1/10/100
5733 72	20A - Switch - SP - 2 Way - with Indicator - Left - 1 Module	1014	1/20/200
5733 73	20A - Switch - SP - 2 Way - with Indicator - Right - 1 Module	1014	1/20/200
5731 71	20A - Switch - SP - 2 Way - with Indicator - 2 Module	962	1/5/50
5731 72	20A - Switch - 3 Gang - 1 Way - 2 Module	2014	1/5/50
5731 73	20A - Switch - 3 Gang - 2*2 Way + 1*1 Way - 2 Module	2124	1/5/50
5733 92	20A - Switch - DP - 1 Way - with Indicator - 2 Module	1572	1/10/100
5731 27	20A - Switch - SP - 2 Way - with Indicator - Middle - 1 Module	1016	1/5/50

Switches - 32A - 230V AC

5733 76	32A - Switch - DP - 1 Way - with Indicator - 2 Module	2270	1/10/100
---------	---	------	----------

Push Button - 6A - 230V AC

5733 81	6A - Bell Push - SP - 1 Way - Right - 1 Module	574	1/20/200
5733 80	6A - Bell Push - SP - 1 Way - Left - 1 Module	574	1/20/200
5733 96	6A - Bell Push - SP - 1 Way - 2 Module	816	1/10/100
5733 97	6A - Bell Push - SP - 1 Way - with Indicator - 2 Module	1072	1/10/100

* MRP - Maximum Retail Price Inclusive of all taxes including GST.

Bold Cat.Nos are products normally available with Legrand (India) Stockists. Cat.Nos that are not bold - delivery within 4 - 8 weeks from the date of order. Bold packing quantity is our mandatory packing. Orders to be placed by Legrand (India) Stockist in multiples of the same.

Arteor™

Round Magnesium Mechanism

Cat.Nos	Description	MRP* ₹ / Unit	Pack
---------	-------------	------------------	------

Electronic Roller Blinds Control

5737 20	Double Switch for Electric Shutter - 2 Module	1434	1/10/100
---------	---	------	----------

Dimmers & Fan Regulators

5733 66	Light Dimmer - 60 to 400 Watts - 2 Module	2396	1/10/100
5731 03	Fan Step Regulator - 100 Watts - ISI - 2 Module	2410	1/10/100
5731 69	Fan Step Regulator - 120 Watts - ISI - 2 Module	2598	1/10/100
5731 04	Fan Step Regulator - for Energy Saving Fans - 2 Module	2570	1/10/100



5731 03

Indian Standard Sockets

5736 94	6A - Socket - with Shutter - 3 Pin - ISI - 2 Module	864	1/20/200
---------	---	-----	----------



5728 24

Data & Voice

5728 24	Information Socket - RJ45 - Cat 6 - UTP - 2 Module	1727	10/100
---------	--	------	--------



5725 74

Hotel "DND and MMR" Functions

5725 74	Internal DND & MMR Control Unit - 2 Module	3264	1/5/50
5725 67	External DND & MMR Control Unit - with Bell Push - 2 Module	3906	5/40



5725 67

Blanking Plate

5731 87	Blanking Plate - 2 Module	146	1/10/100
---------	---------------------------	-----	----------



5731 87

Round - Champagne Mechanism

Switches - 6A - 230V AC

5749 00	6A - Switch - SP - 1 Way - Left - 1 Module	400	1/20/200
5749 01	6A - Switch - SP - 1 Way - Right - 1 Module	400	1/20/200
5749 02	6A - Switch - SP - 1 Way - Middle - 1 Module	400	1/20/200
5749 03	6A - Switch - SP - 2 Way - Left - 1 Module	528	1/20/200
5749 04	6A - Switch - SP - 2 Way - Right - 1 Module	528	1/20/200
5749 05	6A - Switch - SP - 1 Way - with Indicator - Left - 1 Module	586	1/20/200
5749 06	6A - Switch - SP - 1 Way - with Indicator - Right - 1 Module	586	1/20/200
5749 07	6A - Switch - SP - 1 Way - with Indicator - Middle - 1 Module	586	1/20/200



5749 00



5749 01



5749 02



5749 03

Arteor™

Round Champagne Mechanism

Cat.Nos	Description	MRP* ₹ / Unit	Pack
---------	-------------	------------------	------

5749 08	6A - Switch - SP - 2 Way - with Indicator - Left - 1 Module	756	1/20/200
5749 09	6A - Switch - SP - 2 Way - with Indicator - Right - 1 Module	756	1/20/200

Switches - 20A - 230V AC

5749 10	20A - Switch - SP - 1 Way - Left - 1 Module	698	1/20/200
5749 11	20A - Switch - SP - 1 Way - Right - 1 Module	698	1/20/200
5749 12	20A - Switch - SP - 1 Way - Middle - 1 Module	698	1/20/200
5749 13	20A - Switch - SP - 1 Way - 2 Module	830	1/10/200
5749 14	20A - Switch - SP - 1 Way - with Indicator - Left - 1 Module	732	1/20/200
5749 15	20A - Switch - SP - 1 Way - with Indicator - Right - 1 Module	732	1/20/200
5749 16	20A - Switch - SP - 2 Way - Middle - 1 Module	742	1/20/200
5749 17	20A - Switch - SP - 2 Way - with Indicator - Left - 1 Module	1016	1/20/200
5749 18	20A - Switch - SP - 2 Way - with Indicator - Right - 1 Module	1016	1/20/200
5749 19	20A - Switch - SP - 2 Way - with Indicator - 2 Module	962	1/10/100
5749 20	20A - Switch - 3 Gang - 1 Way - 2 Module	2014	1/10/100
5749 21	20A - Switch - 3 Gang - 2*2 Way + 1*1 Way - 2 Module	2124	1/10/100
5749 22	20A - Switch - DP - 1 Way - with Indicator - 2 Module	1572	1/10/100



5749 16



5749 17



5749 18



5749 22

Push Button - 6A - 230V AC

5749 23	6A - Bell Push - SP - 1 Way - Right - 1 Module	574	1/20/200
5749 24	6A - Bell Push - SP - 1 Way - Left - 1 Module	574	1/20/200
5749 25	6A - Bell Push - SP - 1 Way - 2 Module	816	1/10/100
5749 26	6A - Bell Push - SP - 1 Way - with Indicator - 2 Module	1072	1/10/100



5749 26

Dimmers & Fan Regulators

5749 27	Light Dimmer - 60 to 400 Watts - 2 Module	2476	10/100
5749 29	Fan Step Regulator - 100 Watts - ISI - 2 Module	2410	1/10/100
5749 30	Fan Step Regulator - 120 Watts - ISI - 2 Module	2598	1/10/100
5749 31	Fan Step Regulator - for Energy Saving Fans - 2 Module	2570	1/10/100



5749 27



5749 29

* MRP - Maximum Retail Price Inclusive of all taxes including GST.

Bold Cat.Nos are products normally available with Legrand (India) Stockists. **Cat.Nos** that are not bold - delivery within 4 - 8 weeks from the date of order. **Bold packing quantity** is our mandatory packing. Orders to be placed by Legrand (India) Stockist in multiples of the same.

Arteor™

Square Cover Plates with Metal Frame

Cat.Nos	Description	MRP* ₹ / Unit	Pack
Indian Standard Sockets			
5749 94	6A - Socket - with Shutter - 3 Pin - ISI - 2 Module	864	1/20/200

Blanking Plate

5749 64	Blanking Plate - 2 Module	146	10/100
---------	---------------------------	-----	--------

Square Cover Plates with Metal Frame White Cover Plates with Metal Frame

5757 00	Cover Plate - 1 Module - White	326	10/100
5757 10	Cover Plate - 2 Module - White	344	10/100
5757 20	Cover Plate - 3 Module - White	386	10/100
5757 30	Cover Plate - 4 Module - White	404	5/50
5757 40	Cover Plate - 6 Module - White	738	5/30
5757 50	Cover Plate - 8 Module - White	820	5/30
5757 60	Cover Plate - 2*4 Module - White	1034	2/20
5757 70	Cover Plate - 2*6 Module - White	1264	2/16
5757 80	Cover Plate - 2*8 Module - White	1514	2/16
5757 90	Cover Plate - 3*6 Module - White	1676	2/12
5758 00	Cover Plate - 3*8 Module - White	2002	2/12
5750 70	Cover Plate - for Shaver Socket-3 Module - White	574	5/50

Pearl Aluminium Cover Plates with Metal Frame

5759 73	Cover Plate - 1 Module - Pearl Aluminium	488	10/100
5759 74	Cover Plate - 2 Module - Pearl Aluminium	506	1/10/100
5759 75	Cover Plate - 3 Module - Pearl Aluminium	548	10/100
5759 76	Cover Plate - 4 Module - Pearl Aluminium	620	5/50
5759 77	Cover Plate - 6 Module - Pearl Aluminium	1068	5/30
5759 78	Cover Plate - 8 Module - Pearl Aluminium	1170	1/5/30
5759 79	Cover Plate - 2*4 Module - Pearl Aluminium	1492	2/20
5759 80	Cover Plate - 2*6 Module - Pearl Aluminium	1934	1/2/16
5759 81	Cover Plate - 2*8 Module - Pearl Aluminium	2188	2/16
5759 82	Cover Plate - 3*6 Module - Pearl Aluminium	2560	2/12
5759 83	Cover Plate - 3*8 Module - Pearl Aluminium	2914	2/12

Graphite Cover Plates with Metal Frame

5759 61	Cover Plate - 1 Module - Graphite	488	10/100
5759 62	Cover Plate - 2 Module - Graphite	506	1/10/100
5759 63	Cover Plate - 3 Module - Graphite	548	10/100
5759 64	Cover Plate - 4 Module - Graphite	620	5/50
5759 66	Cover Plate - 6 Module - Graphite	1068	5/30

Arteor™

Square Cover Plates with Metal Frame

Cat.Nos	Description	MRP* ₹ / Unit	Pack
---------	-------------	------------------	------

Graphite Cover Plates with Metal Frame

5759 67	Cover Plate - 8 Module - Graphite	1170	1/5/30
5759 68	Cover Plate - 2*4 Module - Graphite	1492	2/20
5759 69	Cover Plate - 2*6 Module - Graphite	1934	1/2/16
5759 70	Cover Plate - 2*8 Module - Graphite	2188	2/16
5759 71	Cover Plate - 3*6 Module - Graphite	2560	2/12
5759 72	Cover Plate - 3*8 Module - Graphite	2914	2/12

Magnesium Cover Plates with Metal Frame

5755 89	Cover Plate - 1 Module - Magnesium	488	10/100
5755 90	Cover Plate - 2 Module - Magnesium	506	1/10/100
5755 91	Cover Plate - 3 Module - Magnesium	548	10/100
5755 93	Cover Plate - 4 Module - Magnesium	620	5/50
5755 94	Cover Plate - 6 Module - Magnesium	1068	1/5/30
5755 95	Cover Plate - 8 Module - Magnesium	1170	1/5/30
5755 96	Cover Plate - 2*4 Module - Magnesium	1492	1/2/20
5755 97	Cover Plate - 2*6 Module - Magnesium	1934	1/2/16
5755 98	Cover Plate - 2*8 Module - Magnesium	2188	2/16
5755 99	Cover Plate - 3*6 Module - Magnesium	2560	2/12

Champagne Cover Plates with Metal Frame

5759 84	Cover Plate - 1 Module - Champagne	488	10/100
5759 85	Cover Plate - 2 Module - Champagne	506	1/10/100
5759 86	Cover Plate - 3 Module - Champagne	548	10/100
5759 87	Cover Plate - 4 Module - Champagne	620	5/50
5759 88	Cover Plate - 6 Module - Champagne	1068	5/30
5759 89	Cover Plate - 8 Module - Champagne	1170	1/5/30
5759 90	Cover Plate - 2*4 Module - Champagne	1492	2/20
5759 91	Cover Plate - 2*6 Module - Champagne	1934	1/2/16
5759 92	Cover Plate - 2*8 Module - Champagne	2188	2/16
5759 93	Cover Plate - 3*6 Module - Champagne	2560	2/12

Dark Bronze Cover Plates with Metal Frame

5756 79	Cover Plate - 1 Module - Dark Bronze	488	10/100
5756 80	Cover Plate - 2 Module - Dark Bronze	506	1/10/100
5756 81	Cover Plate - 3 Module - Dark Bronze	548	10/100

* MRP - Maximum Retail Price Inclusive of all taxes including GST.

Bold Cat.Nos are products normally available with Legrand (India) Stockists. Cat.Nos that are not bold - delivery within 4 - 8 weeks from the date of order. Bold packing quantity is our mandatory packing. Orders to be placed by Legrand (India) Stockist in multiples of the same.

Arteor™

Square Cover Plates with Metal Frame

Cat.Nos	Description	MRP* ₹ / Unit	Pack
---------	-------------	------------------	------

Dark Bronze Cover Plates with Metal Frame

5756 83	Cover Plate - 4 Module - Dark Bronze	620	5/50
5756 84	Cover Plate - 6 Module - Dark Bronze	1068	5/30
5756 85	Cover Plate - 8 Module - Dark Bronze	1170	1/5/30
5756 86	Cover Plate - 2*4 Module - Dark Bronze	1492	2/20
5756 87	Cover Plate - 2*6 Module - Dark Bronze	1934	1/2/16
5756 88	Cover Plate - 2*8 Module - Dark Bronze	2188	2/16
5756 89	Cover Plate - 3*6 Module - Dark Bronze	2560	2/12

Pearl Aluminium Cover Plates with Overmoulded Frame

5757 01	Cover Plate - 1 Module - Pearl Aluminium	540	10/100
5757 11	Cover Plate - 2 Module - Pearl Aluminium	572	10/100
5757 21	Cover Plate - 3 Module - Pearl Aluminium	608	10/100
5757 31	Cover Plate - 4 Module - Pearl Aluminium	690	5/50
5757 41	Cover Plate - 6 Module - Pearl Aluminium	1172	5/30
5757 51	Cover Plate - 8 Module - Pearl Aluminium	1302	5/30
5757 61	Cover Plate - 2*4 Module - Pearl Aluminium	1652	2/20
5757 71	Cover Plate - 2*6 Module - Pearl Aluminium	2146	2/16
5757 81	Cover Plate - 2*8 Module - Pearl Aluminium	2438	2/16
5757 91	Cover Plate - 3*6 Module - Pearl Aluminium	2852	2/12
5758 01	Cover Plate - 3*8 Module - Pearl Aluminium	3236	2/12
5750 71	Cover Plate - for Shaver Socket-3 Module - Pearl Aluminium	920	5/50

Graphite Cover Plates with Overmoulded Frame

5757 02	Cover Plate - 1 Module - Graphite	540	10/100
5757 12	Cover Plate - 2 Module - Graphite	572	10/100
5757 22	Cover Plate - 3 Module - Graphite	608	10/100
5757 32	Cover Plate - 4 Module - Graphite	690	5/50
5757 42	Cover Plate - 6 Module - Graphite	1172	5/30
5757 52	Cover Plate - 8 Module - Graphite	1302	5/30
5757 62	Cover Plate - 2*4 Module - Graphite	1652	2/20
5757 72	Cover Plate - 2*6 Module - Graphite	2146	2/16

Arteor™

Square Cover Plates

Cat.Nos	Description	MRP* ₹ / Unit	Pack
---------	-------------	------------------	------

Graphite Cover Plates with Overmoulded Frame

5757 82	Cover Plate - 2*8 Module - Graphite	2438	2/16
5757 92	Cover Plate - 3*6 Module - Graphite	2852	2/12
5758 02	Cover Plate - 3*8 Module - Graphite	3238	2/12
5750 72	Cover Plate - for Shaver Socket-3 Module - Graphite	920	5/50

Magnesium Cover Plates with Overmoulded Frame

5758 11	Cover Plate - 1 Module - Magnesium	540	10/100
5758 12	Cover Plate - 2 Module - Magnesium	572	10/100
5758 13	Cover Plate - 3 Module - Magnesium	608	10/100
5758 14	Cover Plate - 4 Module - Magnesium	690	1/5/50
5758 15	Cover Plate - 6 Module - Magnesium	1172	5/30
5758 16	Cover Plate - 8 Module - Magnesium	1302	5/30
5758 17	Cover Plate - 2*4 Module - Magnesium	1652	2/20
5758 18	Cover Plate - 2*6 Module - Magnesium	2146	2/16
5758 19	Cover Plate - 2*8 Module - Magnesium	2438	2/16
5758 20	Cover Plate - 3*6 Module - Magnesium	2852	2/12
5758 21	Cover Plate - for Shaver Socket-3 Module - Magnesium	924	5/50

Champagne Cover Plates with Overmoulded Frame

5758 22	Cover Plate - 1 Module - Champagne	540	10/100
5758 23	Cover Plate - 2 Module - Champagne	572	10/100
5758 24	Cover Plate - 3 Module - Champagne	608	10/100
5758 25	Cover Plate - 4 Module - Champagne	690	5/50
5758 26	Cover Plate - 6 Module - Champagne	1172	5/30
5758 27	Cover Plate - 8 Module - Champagne	1302	5/30
5758 28	Cover Plate - 2*4 Module - Champagne	1652	2/20
5758 29	Cover Plate - 2*6 Module - Champagne	2146	2/16
5758 30	Cover Plate - 2*8 Module - Champagne	2438	2/16
5758 31	Cover Plate - 3*6 Module - Champagne	2852	2/12
5758 32	Cover Plate - for Shaver Socket-3 Module - Champagne	924	5/50

Bold Cat.Nos are products normally available with Legrand (India) Stockists. **Cat.Nos that are not bold** - delivery within 4 - 8 weeks from the date of order. **Bold packing quantity** is our mandatory packing. Orders to be placed by Legrand (India) Stockist in multiples of the same.

Arteor™

Square Cover Plates

Cat.Nos	Description	MRP* ₹ / Unit	Pack
Dark Bronze Cover Plates with Overmoulded Frame			
5758 33	Cover Plate - 1 Module - Dark Bronze	540	10/100
5758 34	Cover Plate - 2 Module - Dark Bronze	572	10/100
5758 35	Cover Plate - 3 Module - Dark Bronze	608	10/100
5758 36	Cover Plate - 4 Module - Dark Bronze	690	5/50
5758 37	Cover Plate - 6 Module - Dark Bronze	1172	5/30
5758 38	Cover Plate - 8 Module - Dark Bronze	1302	5/30
5758 39	Cover Plate - 2*4 Module - Dark Bronze	1652	2/20
5758 40	Cover Plate - 2*6 Module - Dark Bronze	2146	2/16
5758 41	Cover Plate - 2*8 Module - Dark Bronze	2438	2/16
5758 42	Cover Plate - 3*6 Module - Dark Bronze	2852	2/12
5758 43	Cover Plate - for Shaver Socket-3 Module - Dark Bronze	924	5/50

Mirror Finish Cover Plates with Overmoulded Frame Mirror Black Cover Plates with Overmoulded Frame

5757 03	Cover Plate - 1 Module - Mirror Black	2756	1/5/30
5757 13	Cover Plate - 2 Module - Mirror Black	2948	1/5/30
5757 23	Cover Plate - 3 Module - Mirror Black	3158	1/20
5757 33	Cover Plate - 4 Module - Mirror Black	3354	1/20
5757 43	Cover Plate - 6 Module - Mirror Black	6106	1/5
5757 53	Cover Plate - 8 Module - Mirror Black	6726	1/5
5757 63	Cover Plate - 2*4 Module - Mirror Black	8524	1/10
5757 73	Cover Plate - 2*6 Module - Mirror Black	10486	1/8

Mirror White Cover Plates with Overmoulded Frame

5757 04	Cover Plate - 1 Module - Mirror White	2756	1/5/30
5757 14	Cover Plate - 2 Module - Mirror White	2948	1/5/30
5757 24	Cover Plate - 3 Module - Mirror White	3158	1/20
5757 34	Cover Plate - 4 Module - Mirror White	3354	1/20
5757 44	Cover Plate - 6 Module - Mirror White	6106	1/5
5757 54	Cover Plate - 8 Module - Mirror White	6726	1/5
5757 64	Cover Plate - 2*4 Module - Mirror White	8680	1/10
5757 74	Cover Plate - 2*6 Module - Mirror White	10486	1/8

Arteor™

Square Cover Plates

Cat.Nos	Description	MRP* ₹ / Unit	Pack
Mirror Green Apple Cover Plates with Overmoulded Frame			
5758 44	Cover Plate - 1 Module - Green Apple	2756	1/5/30
5758 45	Cover Plate - 2 Module - Green Apple	2948	1/5/30
5758 46	Cover Plate - 3 Module - Green Apple	3158	1/20
5758 47	Cover Plate - 4 Module - Green Apple	3354	1/20
5758 48	Cover Plate - 6 Module - Green Apple	6106	1/5
5758 49	Cover Plate - 8 Module - Green Apple	6726	1/5
5758 50	Cover Plate - 2*4 Module - Green Apple	8678	1/10
5758 51	Cover Plate - 2*6 Module - Green Apple	10486	1/8
5758 52	Cover Plate - for Shaver Socket-3 Module - Green Apple	4598	1/5/50

Graphic Casual Cover Plates with Overmoulded Frame

5762 91	Cover Plate - 1 Module - Graphic Casual	3346	1/5/30
5763 11	Cover Plate - 2 Module - Graphic Casual	3600	1/5/30
5763 31	Cover Plate - 3 Module - Graphic Casual	3868	1/20
5763 51	Cover Plate - 4 Module - Graphic Casual	4128	1/20
5763 81	Cover Plate - 6 Module - Graphic Casual	7474	1/5
5764 01	Cover Plate - 8 Module - Graphic Casual	8244	1/5
5758 89	Cover Plate - 2*4 Module - Graphic Casual	10380	1/10
5758 90	Cover Plate - 2*6 Module - Graphic Casual	12850	1/8

Silver Baroque Cover Plates with Overmoulded Frame

5758 53	Cover Plate - 1 Module - Silver Baroque	3346	1/5/30
5758 54	Cover Plate - 2 Module - Silver Baroque	3600	1/5/30
5758 55	Cover Plate - 3 Module - Silver Baroque	3868	1/0/20
5758 56	Cover Plate - 4 Module - Silver Baroque	4128	1/0/20
5758 57	Cover Plate - 6 Module - Silver Baroque	7474	1/0/5

* MRP - Maximum Retail Price Inclusive of all taxes including GST.

Bold Cat.Nos are products normally available with Legrand (India) Stockists. **Cat.Nos that are not bold** - delivery within 4 - 8 weeks from the date of order. **Bold packing quantity** is our mandatory packing. Orders to be placed by Legrand (India) Stockist in multiples of the same.

Arteor™

Square Cover Plates

Cat.Nos	Description	MRP* ₹ / Unit	Pack
5758 58	Cover Plate - 8 Module - Silver Baroque	8244	1/0/5
5758 59	Cover Plate - 2*4 Module - Silver Baroque	10380	1/0/10
5758 60	Cover Plate - 2*6 Module - Silver Baroque	12850	1/0/8
5758 61	Cover Plate - for Shaver Socket-3 Module - Silver Baroque	5284	1/5/50

Dark Baroque Cover Plates with Overmoulded Frame

5758 62	Cover Plate - 1 Module - Dark Baroque	3346	1/5/30
5758 63	Cover Plate - 2 Module - Dark Baroque	3600	1/5/30
5758 64	Cover Plate - 3 Module - Dark Baroque	3868	1/0/20
5758 65	Cover Plate - 4 Module - Dark Baroque	4128	1/0/20
5758 66	Cover Plate - 6 Module - Dark Baroque	7474	1/0/5
5758 67	Cover Plate - 8 Module - Dark Baroque	8244	1/0/5
5758 68	Cover Plate - 2*4 Module - Dark Baroque	10378	1/0/10
5758 69	Cover Plate - 2*6 Module - Dark Baroque	12850	1/0/8
5758 70	Cover Plate - for Shaver Socket-3 Module - Dark Baroque	5284	1/5/50

Metal Finish Cover Plates with Overmoulded Frame

Gold Brass Cover Plates with Overmoulded Frame

5762 90	Cover Plate - 1 Module - Gold Brass	4492	1/5/30
5763 10	Cover Plate - 2 Module - Gold Brass	4808	1/5/30
5763 30	Cover Plate - 3 Module - Gold Brass	5172	1/0/20
5763 50	Cover Plate - 4 Module - Gold Brass	5486	1/0/20
5763 80	Cover Plate - 6 Module - Gold Brass	9986	1/0/5
5764 00	Cover Plate - 8 Module - Gold Brass	10976	1/0/5

* MRP - Maximum Retail Price Inclusive of all taxes including GST.

Arteor™

Square Cover Plates

Cat.Nos	Description	MRP* ₹ / Unit	Pack
---------	-------------	------------------	------

Stainless Steel Cover Plates with Overmoulded Frame

5757 06	Cover Plate - 1 Module - Stainless Steel	4492	1/5/30
5757 16	Cover Plate - 2 Module - Stainless Steel	4808	1/5/30
5757 26	Cover Plate - 3 Module - Stainless Steel	5172	1/20
5757 36	Cover Plate - 4 Module - Stainless Steel	5486	1/20
5757 46	Cover Plate - 6 Module - Stainless Steel	9986	1/5
5757 56	Cover Plate - 8 Module - Stainless Steel	10976	1/0/5
5757 66	Cover Plate - 2*4 Module - Stainless Steel	13878	1/0/10
5757 76	Cover Plate - 2*6 Module - Stainless Steel	17104	1/8

Signature Cover Plates with Overmoulded Frame

5758 71	Cover Plate - 1 Module - Cube Plate	8610	1/5/30
5758 72	Cover Plate - 2 Module - Cube Plate	8764	1/5/30
5758 73	Cover Plate - 3 Module - Cube Plate	10024	1/20
5758 74	Cover Plate - 4 Module - Cube Plate	10358	1/20
5758 75	Cover Plate - 6 Module - Cube Plate	13492	1/5
5758 76	Cover Plate - 8 Module - Cube Plate	14158	1/5
5758 77	Cover Plate - 2*4 Module - Cube Plate	21154	1/10
5758 78	Cover Plate - 2*6 Module - Cube Plate	23434	1/8
5758 79	Cover Plate - for Shaver Socket-3 Module - Cube Plate	9610	1/5/50

Bold Cat.Nos are products normally available with Legrand (India) Stockists. **Cat.Nos** that are not bold - delivery within 4 - 8 weeks from the date of order. **Bold packing quantity** is our mandatory packing. Orders to be placed by Legrand (India) Stockist in multiples of the same.

Arteor™

Round Cover Plates

Cat.Nos	Description	MRP* ₹ / Unit	Pack
---------	-------------	------------------	------

Round Cover Plates with Metal Frame

Round - White Cover Plates with Metal Frame

5759 00	Cover Plate - 2 Module - White	498	10/100
5759 10	Cover Plate - 3 Module - White	526	10/100
5759 20	Cover Plate - 4 Module - White	554	5/50
5759 30	Cover Plate - 6 Module - White	1012	5/30
5765 80	Cover Plate - 8 Module - White	1118	5/30
5759 40	Cover Plate - 2*4 Module - White	1180	2/20
5759 50	Cover Plate - 2*6 Module - White	1720	2/16

Round - Pearl Aluminium Cover Plates with Metal Frame

5757 93	Cover Plate - 2 Module - Pearl Aluminium	668	10/100
5757 94	Cover Plate - 3 Module - Pearl Aluminium	722	10/100
5757 95	Cover Plate - 4 Module - Pearl Aluminium	812	5/50
5757 96	Cover Plate - 6 Module - Pearl Aluminium	1382	5/30
5757 97	Cover Plate - 8 Module - Pearl Aluminium	1532	5/30
5757 98	Cover Plate - 2*4 Module - Pearl Aluminium	1932	2/20
5757 99	Cover Plate - 2*6 Module - Pearl Aluminium	2518	2/16

Round - Graphite Cover Plates with Metal Frame

5758 03	Cover Plate - 2 Module - Graphite	668	10/100
5758 04	Cover Plate - 3 Module - Graphite	722	10/100
5758 05	Cover Plate - 4 Module - Graphite	812	5/50
5758 06	Cover Plate - 6 Module - Graphite	1376	5/30
5758 07	Cover Plate - 8 Module - Graphite	1532	5/30
5758 08	Cover Plate - 2*4 Module - Graphite	1932	2/20
5758 09	Cover Plate - 2*6 Module - Graphite	2518	2/16

Round - Magnesium Cover Plates with Metal Frame

5756 23	Cover Plate - 2 Module - Magnesium	668	10/100
5756 24	Cover Plate - 3 Module - Magnesium	722	10/100
5756 25	Cover Plate - 4 Module - Magnesium	812	5/50
5756 26	Cover Plate - 6 Module - Magnesium	1376	5/30
5756 27	Cover Plate - 8 Module - Magnesium	1528	5/30
5756 28	Cover Plate - 2*4 Module - Magnesium	1932	2/20
5756 29	Cover Plate - 2*6 Module - Magnesium	2518	2/16



5759 00



5759 10



5759 30



5759 80



5759 50



5759 41



5759 22

Arteor™

Round Cover Plates

Cat.Nos	Description	MRP* ₹ / Unit	Pack
---------	-------------	------------------	------

Round - Champagne Cover Plates with Metal Frame

5758 91	Cover Plate - 2 Module - Champagne	668	10/100
5758 92	Cover Plate - 3 Module - Champagne	722	10/100
5758 93	Cover Plate - 4 Module - Champagne	812	5/50
5758 94	Cover Plate - 6 Module - Champagne	1376	5/30
5758 95	Cover Plate - 8 Module - Champagne	1532	5/30
5758 96	Cover Plate - 2*4 Module - Champagne	1934	2/20
5758 97	Cover Plate - 2*6 Module - Champagne	2518	2/16

Round - Dark Bronze Cover Plates with Metal Frame

5756 93	Cover Plate - 2 Module - Dark Bronze	668	10/100
5756 94	Cover Plate - 3 Module - Dark Bronze	722	10/100
5756 95	Cover Plate - 4 Module - Dark Bronze	810	5/50
5756 96	Cover Plate - 6 Module - Dark Bronze	1376	5/30
5756 97	Cover Plate - 8 Module - Dark Bronze	1528	5/30
5756 98	Cover Plate - 2*4 Module - Dark Bronze	1932	2/20
5756 99	Cover Plate - 2*6 Module - Dark Bronze	2518	2/16

Round - Pearl Aluminium Cover Plates with Overmoulded frame

5759 01	Cover Plate - 2 Module - Pearl Aluminium	754	10/100
5759 11	Cover Plate - 3 Module - Pearl Aluminium	796	10/100
5759 21	Cover Plate - 4 Module - Pearl Aluminium	842	5/50
5759 31	Cover Plate - 6 Module - Pearl Aluminium	1532	5/30
5765 81	Cover Plate - 8 Module - Pearl Aluminium	1684	5/30
5759 41	Cover Plate - 2*4 Module - Pearl Aluminium	1768	2/20
5759 51	Cover Plate - 2*6 Module - Pearl Aluminium	2616	2/16

Round - Graphite Cover Plates with Overmoulded Frame

5759 02	Cover Plate - 2 Module - Graphite	754	10/100
5759 12	Cover Plate - 3 Module - Graphite	796	10/100
5759 22	Cover Plate - 4 Module - Graphite	842	5/50
5759 32	Cover Plate - 6 Module - Graphite	1532	5/30
5765 82	Cover Plate - 8 Module - Graphite	1684	5/30
5759 42	Cover Plate - 2*4 Module - Graphite	1768	2/20

* MRP - Maximum Retail Price Inclusive of all taxes including GST.

Bold Cat.Nos are products normally available with Legrand (India) Stockists. Cat.Nos that are not bold - delivery within 4 - 8 weeks from the date of order. Bold packing quantity is our mandatory packing. Orders to be placed by Legrand (India) Stockist in multiples of the same.

Arteor™

Round Cover Plates

Cat.Nos	Description	MRP* ₹ / Unit	Pack
---------	-------------	------------------	------

Round - Graphite Cover Plates with Overmoulded Frame

5759 52	Cover Plate - 2*6 Module - Graphite	2616	2/16
---------	-------------------------------------	------	------

Round - Magnesium Cover Plates with Overmoulded Frame

5768 41	Cover Plate - 2 Module - Magnesium	754	10/100
5768 42	Cover Plate - 3 Module - Magnesium	796	10/100
5768 43	Cover Plate - 4 Module - Magnesium	842	5/50
5768 44	Cover Plate - 6 Module - Magnesium	1532	5/30
5768 45	Cover Plate - 8 Module - Magnesium	1684	5/30
5768 46	Cover Plate - 2*4 Module - Magnesium	1768	2/20
5768 47	Cover Plate - 2*6 Module - Magnesium	2616	2/16

Round - Champagne Cover Plates with Overmoulded Frame

5768 48	Cover Plate - 2 Module - Champagne	754	10/100
5768 49	Cover Plate - 3 Module - Champagne	796	10/100
5768 50	Cover Plate - 4 Module - Champagne	842	5/50
5768 51	Cover Plate - 6 Module - Champagne	1532	5/30
5768 52	Cover Plate - 8 Module - Champagne	1684	5/30
5768 53	Cover Plate - 2*4 Module - Champagne	1768	2/20
5768 54	Cover Plate - 2*6 Module - Champagne	2616	2/16

Round - Dark Bronze Cover Plates with Overmoulded Frame

5768 55	Cover Plate - 2 Module - Dark Bronze	754	10/100
5768 56	Cover Plate - 3 Module - Dark Bronze	796	10/100
5768 57	Cover Plate - 4 Module - Dark Bronze	842	5/50
5768 58	Cover Plate - 6 Module - Dark Bronze	1532	5/30
5768 59	Cover Plate - 8 Module - Dark Bronze	1684	5/30
5768 60	Cover Plate - 2*4 Module - Dark Bronze	1768	2/20
5768 61	Cover Plate - 2*6 Module - Dark Bronze	2616	2/16

Round Mirror Finish Cover Plates

Round - Mirror Black Cover Plates with Overmoulded Frame

5759 03	Cover Plate - 2 Module - Mirror Black	3250	1/5/30
5759 13	Cover Plate - 3 Module - Mirror Black	3486	1/20

* MRP - Maximum Retail Price Inclusive of all taxes including GST.

Arteor™

Round Cover Plates

Cat.Nos	Description	MRP* ₹ / Unit	Pack
---------	-------------	------------------	------

Round Mirror Finish Cover Plates

Round - Mirror Black Cover Plates with Overmoulded Frame

5759 23	Cover Plate - 4 Module - Mirror Black	3708	1/20
5759 33	Cover Plate - 6 Module - Mirror Black	6708	1/5
5765 83	Cover Plate - 8 Module - Mirror Black	7408	1/5
5759 43	Cover Plate - 2*4 Module - Mirror Black	8732	1/10
5759 53	Cover Plate - 2*6 Module - Mirror Black	11544	1/8

Round - Mirror White Cover Plates with Overmoulded Frame

5759 04	Cover Plate - 2 Module - Mirror White	3250	1/5/30
5759 14	Cover Plate - 3 Module - Mirror White	3486	1/20
5759 24	Cover Plate - 4 Module - Mirror White	3708	1/20
5759 34	Cover Plate - 6 Module - Mirror White	6708	1/5
5765 84	Cover Plate - 8 Module - Mirror White	7408	1/5
5759 44	Cover Plate - 2*4 Module - Mirror White	8914	1/10
5759 54	Cover Plate - 2*6 Module - Mirror White	11544	1/8

Round - Green Apple Cover Plates with Overmoulded Frame

5768 62	Cover Plate - 2 Module - Green Apple	3250	1/5/30
5768 63	Cover Plate - 3 Module - Green Apple	3486	1/20
5768 64	Cover Plate - 4 Module - Green Apple	3708	1/20
5768 65	Cover Plate - 6 Module - Green Apple	6706	1/5
5768 66	Cover Plate - 8 Module - Green Apple	7408	1/5
5768 67	Cover Plate - 2*4 Module - Green Apple	8910	1/10
5768 68	Cover Plate - 2*6 Module - Green Apple	11544	1/8

Round - Graphic Casual Cover Plates with Overmoulded Frame

5763 01	Cover Plate - 2 Module - Graphic Casual	3972	1/5/30
---------	---	------	--------

Bold Cat.Nos are products normally available with Legrand (India) Stockists. Cat.Nos that are not bold - delivery within 4 - 8 weeks from the date of order. Bold packing quantity is our mandatory packing. Orders to be placed by Legrand (India) Stockist in multiples of the same.

Arteor™

Round Cover Plates

Cat.Nos	Description	MRP* ₹ / Unit	Pack
---------	-------------	------------------	------

Round - Graphic Casual Cover Plates with Overmoulded Frame

5763 21	Cover Plate - 3 Module - Graphic Casual	4252	1/20
5763 41	Cover Plate - 4 Module - Graphic Casual	4538	1/20
5763 61	Cover Plate - 6 Module - Graphic Casual	8224	1/5
5763 91	Cover Plate - 8 Module - Graphic Casual	9056	1/5
5768 97	Cover Plate - 2*4 Module - Graphic Casual	10864	1/10
5768 98	Cover Plate - 2*6 Module - Graphic Casual	14134	1/8

Round - Silver Baroque Cover Plates with Overmoulded Frame

5768 69	Cover Plate - 2 Module - Silver Baroque	3972	1/5/30
5768 70	Cover Plate - 3 Module - Silver Baroque	4252	1/20
5768 71	Cover Plate - 4 Module - Silver Baroque	4538	1/20
5768 72	Cover Plate - 6 Module - Silver Baroque	8224	1/5
5768 73	Cover Plate - 8 Module - Silver Baroque	9056	1/5
5768 74	Cover Plate - 2*4 Module - Silver Baroque	10864	1/10
5768 75	Cover Plate - 2*6 Module - Silver Baroque	14134	1/8

Round - Dark Baroque Cover Plates with Overmoulded Frame

5768 76	Cover Plate - 2 Module - Dark Baroque	3972	1/5/30
5768 77	Cover Plate - 3 Module - Dark Baroque	4252	1/20
5768 78	Cover Plate - 4 Module - Dark Baroque	4538	1/20
5768 79	Cover Plate - 6 Module - Dark Baroque	8224	1/5
5768 80	Cover Plate - 8 Module - Dark Baroque	9056	1/5
5768 81	Cover Plate - 2*4 Module - Dark Baroque	10864	1/10
5768 82	Cover Plate - 2*6 Module - Dark Baroque	14134	1/8

Arteor™

Round Cover Plates

Cat.Nos	Description	MRP* ₹ / Unit	Pack
---------	-------------	------------------	------

Round - Gold Brass Cover Plates with Overmoulded Frame

5763 00	Cover Plate - 2 Module - Gold Brass	5300	1/5/30
5763 20	Cover Plate - 3 Module - Gold Brass	5660	1/20
5763 40	Cover Plate - 4 Module - Gold Brass	6038	1/20
5763 60	Cover Plate - 6 Module - Gold Brass	10970	1/5
5763 90	Cover Plate - 8 Module - Gold Brass	12086	1/5

Round - Stainless Steel Cover Plates with Overmoulded Frame

5759 06	Cover Plate - 2 Module - Stainless Steel	5300	1/5/30
5759 16	Cover Plate - 3 Module - Stainless Steel	5660	1/20
5759 26	Cover Plate - 4 Module - Stainless Steel	6038	1/20
5759 36	Cover Plate - 6 Module - Stainless Steel	10970	1/5
5765 86	Cover Plate - 8 Module - Stainless Steel	12086	1/5
5759 46	Cover Plate - 2*4 Module - Stainless Steel	15280	1/10
5759 56	Cover Plate - 2*6 Module - Stainless Steel	18808	1/8

* MRP - Maximum Retail Price Inclusive of all taxes including GST.

Bold Cat.Nos are products normally available with Legrand (India) Stockists. Cat.Nos that are not bold - delivery within 4 - 8 weeks from the date of order. Bold packing quantity is our mandatory packing. Orders to be placed by Legrand (India) Stockist in multiples of the same.

Arteor™

Round Cover Plates

Cat.Nos	Description	MRP* ₹ / Unit	Pack
Round - Signature Cover Plates with Overmoulded Frame			
5768 83	Cover Plate - 2 Module - Cube Plate	8764	1/5/30
5768 84	Cover Plate - 3 Module - Cube Plate	10652	1/20
5768 85	Cover Plate - 4 Module - Cube Plate	10848	1/20
5768 86	Cover Plate - 6 Module - Cube Plate	13886	1/5
5768 87	Cover Plate - 8 Module - Cube Plate	14732	1/5
5768 88	Cover Plate - 2*4 Module - Cube Plate	20496	1/10
5768 89	Cover Plate - 2*6 Module - Cube Plate	23190	1/8



5768 84

Accessories

Plastic Surface Boxes

5734 91	Plastic Surface Box - 1/2 Module	144	55
5735 20	Plastic Surface Box - 3 Module	172	42
5735 70	Plastic Surface Box - 4 Module	204	27
5735 71	Plastic Surface Box - 6 Module	254	20
5723 94	Plastic Surface Box - 8 Module	286	20
5735 74	Plastic Surface Box - 2*4 Module	350	10
5735 72	Plastic Surface Box - 12/16 Module	900	11
5735 73	Plastic Surface Box - 18/24 Module	952	8



5735 70

* MRP - Maximum Retail Price Inclusive of all taxes including GST.

Arteor™

Mounting Boxes

Cat.Nos	Description	MRP* ₹ / Unit	Pack
Metal Flush Boxes			
6890 07	Metal Flush Box - 1/2 Module	170	40
6890 08	Metal Flush Box - 3 Module	170	40
6890 09	Metal Flush Box - 4 Module	226	40
6890 10	Metal Flush Box - 6 Module	358	40
6890 42	Metal Flush Box - 8 Module	416	40
6890 31	Metal Flush Box - 2*4 Module	414	20
6890 11	Metal Flush Box - 12/16 Module	624	10
6890 12	Metal Flush Box - 18/24 Module	788	10



6890 08



6890 09



6890 12

IP 55 Plexo Box & Accessories

6846 38	Grey Plexo Box & Adaptor with Transparent Flap-3 Module-IP 66	5620	1
---------	---	------	---



6846 38

IP 55 Plexo Box with PVC Membrane

6806 11	Grey Plexo Box & Adaptor with PVC Membrane-1 Module	1240	10
6806 12	Grey Plexo Box & Adaptor with PVC Membrane-2 Module	1266	10
6806 13	Grey Plexo Box & Adaptor with PVC Membrane-3 Module	1684	10
6806 14	Grey Plexo Box & Adaptor with PVC Membrane-4 Module	2526	5



6806 12



6806 13

Bold Cat.Nos are products normally available with Legrand (India) Stockists. **Cat.Nos** that are not bold - delivery within 4 - 8 weeks from the date of order. **Bold packing quantity** is our mandatory packing. Orders to be placed by Legrand (India) Stockist in multiples of the same.

Arteor™

Mounting Boxes

Cat.Nos	Description	MRP* ₹ / Unit	Pack
IP 55 Plexo Box with PVC Membrane			
6806 19	Grey Plexo Box & Adaptor with PVC Membrane-2 Row*4 Module	4096	5
6806 33	Grey Plexo Flush Adaptor with Membrane-3 Module Arteor Box	1350	20

Arteor™

Guarantee

- The Company, at its discretion, will replace products if they have any manufacturing defect within 10 years for switches (without LED lamp) and power sockets. For all other **Arteor™** wiring accessories the guarantee will be 2 years.
- The above guarantee is applicable when the devices are used in Legrand metal flush boxes. Otherwise the guarantee period will be reduced by 50%.
- The guarantee is only applicable when the products are installed as per the Company's instructions and not tampered in any manner.
- The guarantee states the Company's entire liability. It does not extend to cover consequential loss or damage or installation costs arising from defective products.

Our switches are compliant with revised BIS standard (IS 3854:2023) requirements. Also, our switches are covered additionally for use on Self-Ballasted Lamp (SBL) loads.

SBL power rating as per IS3854:2023

Switch Rating	6A, 230V~	10A, 230V~	16A, 230V~	20A, 230V~
SBL power (Watt)	100 W	100 W	200 W	250 W

* MRP - Maximum Retail Price Inclusive of all taxes including GST.

Bold Cat.Nos are products normally available with Legrand (India) Stockists. Cat.Nos that are not bold - delivery within 4 - 8 weeks from the date of order. Bold packing quantity is our mandatory packing. Orders to be placed by Legrand (India) Stockist in multiples of the same.

Myrius™

A Perfect Blend of Design & Convenience



Myrius™ is designed to enhance modern living spaces by combining refined aesthetics with everyday usability. It brings together thoughtful design and intuitive functionality to create a seamless and comfortable user experience.

Features

- In-Mould decoration (IMD) technology enabling customised smart functions
- Integrated smart functionality for enhanced control and convenience
- Wide range of designer finishes to suit diverse interior styles
- Available in 11 premium plate finish options

Benefits

- Elevates interiors with distinctive designer aesthetics
- Enables personalised living through customised smart features
- Offers flexibility in design with a wide range of finishes
- Enhances everyday convenience with intuitive functionality

Scan to know more about the product.

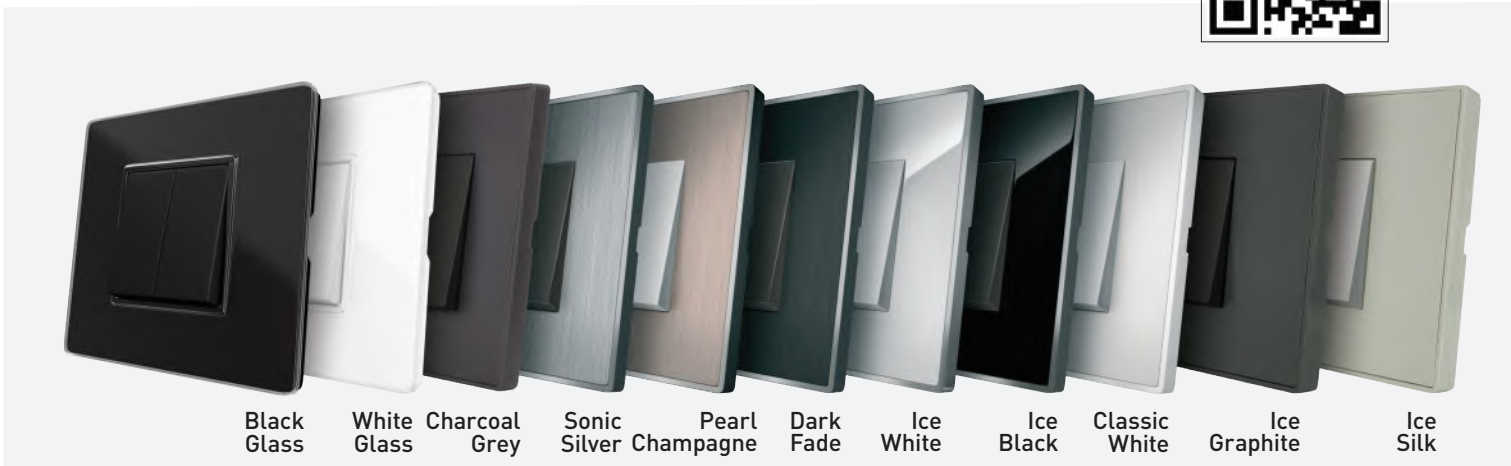

Myrius: The best of both worlds



Myrius™

Premium Glass Finish for Modern Interiors



MYRIUS GLASS FINISH

Myrius™ Glass plate enhances interior spaces with sleek glass finishes and a refined flush design, bringing a modern and sophisticated aesthetic to premium environments.

Features

- 3 mm toughened glass finishes available in white and black
- Plate range from 1 to 18 modules for design flexibility
- Available in multiple colour options

Benefits

- Enhances interior aesthetics with elegant and modern glass finishes
- Adds a modern and sophisticated look to spaces
- Ensures design flexibility across different layouts



Myrius™

Designed for Hygiene.
Built for Everyday
Living.



ANTI-BACTERIAL RANGE

Myrius™ Anti-Bacterial Range is designed to support healthier living by reducing bacterial presence on frequently touched surfaces, combining hygiene with modern design for everyday spaces.

Features

- Silver ion-infused surfaces for antibacterial protection
- Smooth finish for easy cleaning and maintenance
- Certified antibacterial performance
- Contemporary design suitable for modern interiors

Benefits

- Reduces bacterial presence on frequently touched surfaces
- Supports a healthier home environment
- Enhances everyday safety through hygienic materials
- Combines hygiene with modern aesthetics



Myrius™ Cover Plates Cover Plates

Cat.Nos	Description	MRP* ₹ / Unit	Pack
---------	-------------	------------------	------

Switches 6A - 230V AC

6792 00	6A - Switch - 1 Way - 1 Module	160	1/20/200
6792 01	6A - Switch - 2 Way - 1 Module	292	1/20/200
6792 02	6A - Switch - 1 Way - with Indicator - 1 Module	270	1/20/200
6792 03	6A - Switch - 1 Way - with "Light" Marking - 1 Module	230	1/20/200
6792 04	6A - Switch - 1 Way - with "Fan" Marking - 1 Module	230	1/20/200

Switches - 10A - 230V AC

6793 00	10A - Switch - 1 Way - 1 Module	170	20/200
6793 01	10A - Switch - 2 Way - 2 Module	298	20/200
6793 02	10A - Switch - 1 Way - with Indicator - 1 Module	278	20/200
6792 05	10A - Switch - 1 Way - 2 Module	344	1/10/100
6792 06	10A - Switch - 2 Way - 2 Module	408	1/10/100
6792 07	10A - Intermediate Switch - 230V AC - 2 Module	2220	1/10/100
6792 08	10A - Switch - 1 Way - with Indicator - 2 Module	426	1/10/100

Switches - 16A - 230V AC

6792 09	16A - Switch - 1 Way - 1 Module	388	1/20/200
6792 10	16A - Switch - 2 Way - 1 Module	440	1/20/200
6792 11	16A - Switch - 1 Way - with Indicator - 1 Module	468	1/20/200

Switches - 20A - 230V AC

6792 12	20A - Switch - 1 Way - 1 Module	512	1/20/200
6792 13	20A - Switch - DP - 1 Way - 2 Module	784	1/10/100
6792 14	20A - Switch - DP - 1 Way - with Indicator - 2 Module	838	1/10/100
6792 15	20A - Switch - 2 Way - 2 Module	864	1/10/100

Switches - 25A - 230V AC

6792 16	25A - Switch - SP - 1 Way - with Indicator - 1 Module	576	1/20/200
---------	---	-----	----------

Switches - 32A - 230V AC

6792 17	32A - Switch - DP - with Indicator - 2 Module	1284	1/10/100
---------	---	------	----------

Myrius™ Classic White Mechanism

Cat.Nos	Description	MRP* ₹ / Unit	Pack
---------	-------------	------------------	------

Push Button - 6A - 230V AC

6792 18	6A - Push Button - SP - 1 Module	324	1/20/200
6792 19	6A - Push Button - SP - 1 Way - with Indicator - 1 Module	426	1/20/200
6792 20	6A - Bell Push - 1 Way - 1 Module	326	1/20/200
6792 21	6A - Bell Push - 1 Way - with Indicator - 1 Module	426	1/20/200
6792 22	6A - Bell Push - 1 Way - 2 Module	494	1/10/100
6792 23	6A - Bell Push - 1 Way - with Indicator - 2 Module	576	1/10/100

Accessories for Switches

6792 24	Lamp for Switches - 230V AC	80	1/5/50
---------	-----------------------------	----	--------

Indian Standard Socket

6792 35	6A - Socket - with Shutter - 3 Pin - ISI - 2 Module	278	1/20/200
6792 30	6/16A - Socket - with Shutter - ISI - 2 Module	592	1/20/200
6792 29	6/16A - Socket - with Shutter - ISI - 3 Module	708	1/5/50
6792 26	16A - Switch Socket - with Shutter - 3 Pin - 3 Module	1538	1/5/50

Dimmers & Fan Regulators

6792 36	Rotary Dimmer - 400 Watts - 1 Module	1504	5/50
6792 37	Rotary Light Dimmer - 500 Watts - 2 Module	2270	10/100
6792 39	Fan Regulator - 100 Watts - ISI - 1 Module	1168	5/50
6792 40	Fan Regulator - 100 Watts - 360° - ISI - 2 Module	1340	10/100
6792 41	Fan Regulator - 120 Watts - 360° - ISI - 2 Module	1446	10/100
6792 42	Fan Regulator - 70 Watts - ISI - 2 Module	1402	1/10/100
6792 31	Fan Regulator - 8 Step - 100 Watts ISI - 2 Module	1224	10/100
6792 96	Fan Regulator - BLDC - 2 Module [^]	1426	10/100

* MRP - Maximum Retail Price Inclusive of all taxes including GST.

[^] Compatible with Atomberg (Efficio), Havells (Eficiencia neo), Orient (Aerostorm) as per 2023 fan models.

Bold Cat.Nos are products normally available with Legrand (India) Stockists. Cat.Nos that are not bold - delivery within 4 - 8 weeks from the date of order. Bold packing quantity is our mandatory packing. Orders to be placed by Legrand (India) Stockist in multiples of the same.

Myrius™ Classic White Mechanism

Cat.Nos	Description	MRP ₹ / Unit	Pack
---------	-------------	--------------------	------

Emergency Light

6792 43	Emergency Removable LED Lamp - 2 Module	3742	1/10/100
---------	---	------	----------

Skirting Light

6792 48	Skirting Light - with Warm White LED - 3 Module	1132	1/5/25
---------	---	------	--------

Indicator

NEW! 6792 97	Indicator Unit - with Transparent LED - 1 Module	626	1/10/100
---------------------	--	-----	----------

Bell Call Indicator

6792 49	Bell Call Indicator - 1 Module	1492	1/20/200
---------	--------------------------------	------	----------

Buzzer

6792 50	Buzzer - 230V - 1 Module	1378	1/20/200
---------	--------------------------	------	----------

Infrared Sensors

6792 51	Infrared Sensor Switch - 400 Watts - 2 Module	2632	1/50
---------	---	------	------

Remote Unit

6792 52	Remote Control Unit - for Light & Fan - 4 Module	8988	1/5/20
6793 03	Remote Control Hand Unit	794	1/5/30

Hospitality Function Hotel Keycard Switch

6792 53	16A - Key Card Switch - 2 Module	5390	1/10
6792 55	Key Fob for Key Card Switch	234	1/10/100

Hotel "DND and MMR" Functions

6792 56	External DND & MMR Control Unit - with Bell Push - 2 Module	2298	1/10/100
6792 57	Internal DND & MMR Control Unit - 2 Module	1534	1/10/100

Shaver Socket

6792 58	Shaver Socket - 110/230V AC - Monoblock with Plate - 2 Module	4012	1/16
6792 59	Shaver Socket - 110/230V AC - Monoblock with Plate - 4 Module	6552	1/5/20

Tv Sockets

6792 60	TV Co - axial Socket - 1 Module	302	1/20/200
---------	---------------------------------	-----	----------

Data & Voice

6792 62	Telephone Socket - RJ11 - 1 Module	298	1/20/200
6792 63	Telephone Socket - Double RJ11 - 1 Module	460	1/20/200
6792 64	Information Socket - RJ45 - Cat 5E - UTP - Toolless with Shutter - 1 Module	609	1/20/200
6792 65	Information Socket - RJ45 - Cat 6 - UTP - Toolless with Shutter - 1 Module	907	1/20/200
6792 66	Information Socket - RJ45 - Cat 6 - UTP - Toolless with Shutter - 2 Module	925	1/10/100
6797 13	Information Socket - RJ45 - Cat 6A - STP - 1 Module	1065	20/200

Myrius™ Classic White Mechanism

Cat.Nos	Description	MRP ₹ / Unit	Pack
---------	-------------	--------------------	------

Audio Video Connectors

6792 67	Preterminated Audio/Video Connector - 1 Module	2399	1/10
6792 68	Preterminated Projector Connector - 1 Module	2939	1/10
6792 69	Preterminated HDMI Socket - 1 Module	2939	1/10

Sound (Volume Controller)

6792 70	Volume Controller - 2 Module	1795	1/10/100
---------	------------------------------	------	----------

Protectors & Accessories

Motor Starter

6792 71	16A - Motor Starter - 2 Module	952	1/10/100
6792 72	25A - Motor Starter - 2 Module	972	1/10/100

Electronic Function

USB Chargers (IS13252(Part 1) / IEC 60950-1)

6792 88	USB Charger - 1500mA - Type A - 1 Module	2056	1/5/50
6792 89	USB Charger - 3000mA - Type A + C - 2 Module	3180	1/10/100
6797 51	USB Charger - 3000mA/15 Watts - Type A - 1 Module	2376	1/5/50
6797 52	USB Charger - 3000mA/15 Watts - Type A + A - 1 Module	2676	1/5/50
6797 53	USB Charger - 3000mA/15 Watts - Type A + C - 1 Module	3408	1/5/50
6797 54	USB Charger - 3000mA/15 Watts - Type C + C - 1 Module	3722	1/5/50
6797 55	USB Charger - Power Delivery - 20 Watts - Type C - 1 Module	4534	1/5/50
6792 73	USB Charger - Power Delivery - 30 Watts - Type C + C - 2 Module	6878	1/3/30
6797 57	USB Charger - Power Delivery - 45 Watts - Type C - 2 Module	8966	1/3/30
NEW! 6797 59	USB Charger - Power Delivery - 65 Watts - Type C + C - 3 Module	11058	1/5/20

Loud Speakers

6792 98	Ceiling Loudspeaker - 8Ohms - 100mm	3759	1/6
---------	-------------------------------------	------	-----

Sound Diffusion

6792 99	Bluetooth Sound Diffusion - 2 Module	7697	1/10/100
---------	--------------------------------------	------	----------

Rotary Dimmer Universal

6793 04	Rotary LED Light Dimmer - 50 Watts - 1 Module	3110	1/10/120
---------	---	------	----------

* MRP - Maximum Retail Price Inclusive of all taxes including GST.
Red Cat. Nos - New Products

Bold Cat.Nos are products normally available with Legrand (India) Stockists. Cat.Nos that are not bold - delivery within 4 - 8 weeks from the date of order. Bold packing quantity is our mandatory packing. Orders to be placed by Legrand (India) Stockist in multiples of the same.

Myrius™ Classic White Mechanism

Cat.Nos	Description	MRP* ₹ / Unit	Pack
---------	-------------	------------------	------

Touch Switches

6793 08	Touch Switch - 2 Switch - 1 Way - 1000 Watts - 2 Module - Silver	4350	1/50
6793 09	Touch Switch - 1 Way - 1440 Watts - 2 Module - Silver	4350	1/50
6793 10	Touch Switch - 2 Way - 1000 Watts - 2 Module - Silver	5030	1/50
6793 13	Touch Switch - 1 Way - 3000 Watts - 2 Module - Silver	5030	1/50
6793 06	Touch Switch - Bell Push - 1440 Watts - 2 Module - Silver	4350	1/50

Touch Regulator, Curtain & Dimmer

6793 07	Touch Switch - Curtain Controller - 2 Module - Silver	5030	1/50
6793 05	Touch Fan Regulator - 100 Watts - 2 Module - Silver	5030	1/50
6793 15	Universal LED Touch Scroll Dimmer - 300 Watts - 2 Module - Silver	4976	1/50

Reading Light

6793 16	Reading Light LED - 2 Module	3110	1/10
---------	------------------------------	------	------

Accessories

6792 75	Cable Outlet - 8mm - 1 Module	336	1/20/200
6792 76	Blanking Plate - 1 Module	62	1/40/400
6792 77	Blanking Plate - 2 Module	72	1/10/100

Charcoal Grey- Mechanism Switches - 6A - 230V AC

6794 00	6A - Switch - 1 Way - 1 Module	198	1/20/200
6794 01	6A - Switch - 2 Way - 1 Module	324	1/20/200
6794 02	6A - Switch - 1 Way - with Indicator - 1 Module	352	1/20/200
6794 03	6A - Switch - 1 Way - with "Light" Marking - 1 Module	274	1/20/200
6794 04	6A - Switch - 1 Way - with "Fan" Marking - 1 Module	274	1/20/200

Switches - 10A - 230V AC

6794 05	10A - Switch - 1 Way - 2 Module	412	1/10/100
6794 06	10A - Switch - 2 Way - 2 Module	440	1/10/100
6794 07	10A - Intermediate Switch - 230V AC - 2 Module	2558	1/10/100
6794 08	10A - Switch - 1 Way - with Indicator - 2 Module	474	1/10/100

Myrius™ Charcoal Grey Mechanism

Cat.Nos	Description	MRP* ₹ / Unit	Pack
---------	-------------	------------------	------

Switches - 16A - 230V AC

6794 09	16A - Switch - 1 Way - 1 Module	432	1/20/200
6794 10	16A - Switch - 2 Way - 1 Module	526	1/20/200
6794 11	16A - Switch - 1 Way - with Indicator - 1 Module	544	1/20/200

Switches - 20A - 230V AC

6794 12	20A - Switch - 1 Way - 1 Module	582	1/20/200
6794 13	20A - Switch - DP - 1 Way - 2 Module	908	1/10/100
6794 14	20A - Switch - DP - 1 Way - with Indicator - 2 Module	964	1/10/100
6794 15	20A - Switch - 2 Way - 2 Module	992	1/10/100

Switches - 25A - 230V AC

6794 16	25A - Switch - SP - 1 Way - with Indicator - 1 Module	664	1/20/200
---------	---	-----	----------

Switches 32A 230V AC

6794 17	32A - Switch - DP - with Indicator - 2 Module	1480	1/10/100
---------	---	------	----------

Push Button 6A 230V AC

6794 18	6A - Push Button - SP - 1 Way - 1 Module	386	1/20/200
6794 19	6A - Push Button - 1 Way - with Indicator - 1 Module	482	1/20/200
6794 20	6A - Bell Push - 1 Way - 1 Module	360	1/20/200
6794 21	6A - Bell Push - 1 Way - with Indicator - 1 Module	482	1/20/200
6794 22	6A - Bell Push - 1 Way - 2 Module	556	1/10/100
6794 23	6A - Bell Push - 1 Way - with Indicator - 2 Module	664	1/10/100

Indian Standard Socket

6794 35	6A - Socket - with Shutter - 3 Pin - ISI - 2 Module	318	1/20/200
6794 30	6/16A - Socket - with Shutter - ISI - 2 Module	696	1/20/200
6794 29	6/16A - Socket - with Shutter - ISI - 3 Module	822	1/5/50
6794 26	16A - Switched Socket - with Shutter - 3 Pin - 3 Module	1752	1/5/50

* MRP - Maximum Retail Price Inclusive of all taxes including GST.

Bold Cat.Nos are products normally available with Legrand (India) Stockists. Cat.Nos that are not bold - delivery within 4 - 8 weeks from the date of order. Bold packing quantity is our mandatory packing. Orders to be placed by Legrand (India) Stockist in multiples of the same.

Myrius™ Charcoal Grey Mechanism

Cat.Nos	Description	MRP* ₹ / Unit	Pack
---------	-------------	------------------	------

Dimmers & Fan Regulators

6794 36	Rotary Dimmer - 400 Watts - 1 Module	1720	5/50
6794 37	Rotary Light Dimmer - 500 Watts - 2 Module	2612	10/100
6794 39	Fan Regulator - 100 Watts - ISI - 1 Module	1344	5/50
6794 40	Fan Regulator - 100 Watts - 360° - ISI - 2 Module	1522	10/100
6794 41	Fan Regulator - 120 Watts - 360° - ISI - 2 Module	1678	10/100
6794 42	Fan Regulator - 70 Watts - ISI - 2 Module	1620	1/10/100
6794 31	Fan Regulator - 8 Steps - 100 Watts - ISI - 2 Module	1392	10/100
6794 96	Fan Regulator - BLDC - 2 Module ^A	1646	10/100

Skirting Light

6794 48	Skirting Light - with Warm White LED - 3 Module	1296	1/5/25
---------	---	------	--------

Bell Call Indicator

6794 49	Bell Call Indicator - 1 Module	1736	1/20/200
---------	--------------------------------	------	----------

Buzzer

6794 50	Buzzer - 230V - 1 Module	1582	1/20/200
---------	--------------------------	------	----------

Remote Unit

6794 52	Remote Control Unit - for Light & Fan - 4 Module	10332	1/5/20
6793 03	Remote Control Hand Unit	794	1/5/30

Hospitality Function Hotel Keycard Switch

6794 53	16A - Key Card Switch - 2 Module	6200	1/10
6792 55	Key Fob for Key Card Switch	234	1/10/100

Hotel "DND and MMR" Functions

6794 54	External DND & MMR Control Unit - with Bell Push - 2 Module	2636	1/10/100
6794 55	Internal DND & MMR Control Unit - 2 Module	1738	1/10/100

Shaver Socket

6794 58	Shaver Socket - 120/240V AC - Monoblock with Plate - 2 Module	4568	1/16
6794 59	Shaver Socket - 120/230V AC - Monoblock with Plate - 4 Module	7248	1/5/20

Sockets & Connectors

Tv Sockets

6794 60	TV Co - axial Socket - 1 Module	362	1/20/200
---------	---------------------------------	-----	----------

Myrius™ Charcoal Grey Mechanism

Cat.Nos	Description	MRP* ₹ / Unit	Pack
---------	-------------	------------------	------

Data & Voice

6794 62	Telephone Socket - RJ11 - 1 Module	348	1/20/200
6794 63	Telephone Socket - Double RJ11 - 1 Module	534	1/20/200
6794 64	Information Socket - RJ45 - Cat 5E - UTP - Toolless with Shutter - 1 Module	706	1/20/200
6794 65	Information Socket - RJ45 - Cat 6 - UTP - Toolless with Shutter - 1 Module	1042	1/20/200
6794 66	Information Socket - RJ45 - Cat 6 - UTP - Toolless with Shutter - 2 Module	1069	1/10/100
6797 14	Information Socket - RJ45 - Cat 6A - STP - 1 Module	1214	20/200

Audio & Video Connectors

6794 67	Preterminated Audio/Video Connector - 1 Module	2756	1/10
6794 68	Preterminated HDMI Socket - 1 Module	3376	1/10
6794 69	Preterminated Projector Connector - 1 Module	3376	1/10

Sound (Volume Controller)

6794 70	Volume Controller - 2 Module	2083	1/10/100
---------	------------------------------	------	----------

Protectors & Accessories Motor Starter

6794 71	16A - Motor Starter - 2 Module	1098	1/10/100
6794 72	25A - Motor Starter - 2 Module	1122	1/10/100

Electronic Function

USB Chargers (IS13252 (Part 1) / IEC 60950-1)

6794 88	USB Charger - 1500mA - Type A - 1 Module	2358	1/5/100
6794 89	USB Charger - 3000mA - Type A + C - 2 Module	3654	1/10/100
6798 51	USB Charger - 3000mA/15 Watts - Type A - 1 Module	2720	1/5/50
6798 52	USB Charger - 3000mA/15 Watts - Type A + A - 1 Module	3002	1/5/50
6798 53	USB Charger - 3000mA/15 Watts - Type A + C - 1 Module	3826	1/5/50
6798 54	USB Charger - 3000mA/15 Watts - Type C + C - 1 Module	4054	1/5/50
6798 55	USB Charger - Power Delivery - 20 Watts - Type C - 1 Module	5002	1/5/50
6792 74	USB Charger - Power Delivery - 30 Watts - Type C + C - 2 Module	7272	1/3/30
6798 57	USB Charger - Power Delivery - 45 Watts - Type C - 2 Module	9442	1/3/30
6798 59	USB Charger - Power Delivery - 65 Watts - Type C + C - 3 Module	11614	1/5/20

* MRP - Maximum Retail Price Inclusive of all taxes including GST.

^A Compatible with Atomberg (Efficio), Havells (Efficiencia neo), Orient (Aerostorm) as per 2023 fan models.

Red Cat. Nos - New Products

Bold Cat.Nos are products normally available with Legrand (India) Stockists. Cat.Nos that are not bold - delivery within 4 - 8 weeks from the date of order. Bold packing quantity is our mandatory packing. Orders to be placed by Legrand (India) Stockist in multiples of the same.

Myrius™ Classic White Anti Bacterial Mechanism

Cat.Nos	Description	MRP* ₹ / Unit	Pack
---------	-------------	------------------	------

Sound Receiver

6794 97	Bluetooth Sound Diffusion - 2 Module	8854	1/10/100
---------	--------------------------------------	------	----------

Rotary Dimmer Universal

6794 98	Rotary LED Light Dimmer - 50 Watts - 1 Module	3544	1/10/120
---------	---	------	----------

Accessories

6794 75	Cable Outlet - 8mm - 1 Module	392	1/20/200
6794 76	Blanking Plate - 1 Module	68	1/40/400

Classic White - Anti Bacterial Mechanism Switches - 6A - 230V AC

6793 20	6A - Switch - 1 Way - 1 Module - Anti - Bacterial	232	1/20/200
6793 21	6A - Switch - 2 Way - 1 Module - Anti - Bacterial	342	1/20/200
6793 24	6A - Bell Push - 1 Module - Anti - Bacterial	398	1/20/200

Switches - 16A - 230V AC

6793 22	16A - Switch - 1 Way - 1 Module - Anti - Bacterial	468	1/20/200
6793 23	16A - Switch - 2 Way - 1 Module - Anti - Bacterial	544	1/20/200

Indian Standard Socket

6792 38	6A - Socket - with Shutter - 3 Pin - ISI - 2 Module - Anti - Bacterial	348	1/20/200
6793 28	6/16A - Socket - with Shutter - ISI - 2 Module - Anti - Bacterial	812	1/20/200
6793 29	6/16A - Socket - with Shutter - ISI - 3 Module - Anti - Bacterial	874	1/5/50

Fan Regulators

6793 25	Fan Regulator - 120 Watts - 360° - ISI - 2 Module - Anti - Bacterial	1776	10/100
---------	--	------	--------

TV Sockets

6793 30	TV Co - axial Socket - 1 Module - Anti - Bacterial	362	1/20/200
---------	--	-----	----------

Data & Voice

6793 31	Telephone Socket - RJ11 - 1 Module - Anti - Bacterial	362	1/20/200
6793 32	Information Socket - RJ45 - Cat 6 - UTP - 1 Module - Anti - Bacterial	1104	1/20/200

Accessories

6793 33	Blanking Plate - 1 Module - Anti - Bacterial	62	1/40/400
---------	--	----	----------

Myrius™ Cover Plates

Cat.Nos	Description	MRP* ₹ / Unit	Pack
---------	-------------	------------------	------

Cover Plates with Support Frame

Classic White Cover Plates with Support Frame

6795 01	Cover Plate - 1 Module - Classic White	248	20/200
6795 02	Cover Plate - 2 Module - Classic White	258	20/200
6795 03	Cover Plate - 3 Module - Classic White	272	10/100
6795 04	Cover Plate - 4 Module - Classic White	304	10/100
6795 06	Cover Plate - 6 Module - Classic White	526	5/50
6795 08	Cover Plate - 8 Module - Classic White	576	5/50
6795 09	Cover Plate - 2*4 Module - Classic White	732	5/25
6795 10	Cover Plate - 9 Module - Classic White	774	5/50
6795 12	Cover Plate - 12 Module - Classic White	878	1/10
6795 16	Cover Plate - 16 Module - Classic White	1022	1/10
6795 17	Cover Plate - 16 Module (Big) - Classic White	1108	1/10
6795 18	Cover Plate - 18 Module - Classic White	1172	1/10

Charcoal Grey Cover Plates with Support Frame

6797 01	Cover Plate - 1 Module - Charcoal Grey	300	20/200
6797 02	Cover Plate - 2 Module - Charcoal Grey	314	20/200
6797 03	Cover Plate - 3 Module - Charcoal Grey	340	10/100
6797 04	Cover Plate - 4 Module - Charcoal Grey	364	10/100
6797 06	Cover Plate - 6 Module - Charcoal Grey	650	5/50
6797 08	Cover Plate - 8 Module - Charcoal Grey	708	5/50
6797 09	Cover Plate - 2*4 Module - Charcoal Grey	900	5/25
6797 10	Cover Plate - 9 Module - Charcoal Grey	966	5/50
6797 12	Cover Plate - 12 Module - Charcoal Grey	1082	1/10
6797 16	Cover Plate - 16 Module - Charcoal Grey	1252	1/10
6797 17	Cover Plate - 16 Module (Big) - Charcoal Grey	1348	1/10
6797 18	Cover Plate - 18 Module - Charcoal Grey	1440	1/10

Ice White Cover Plates with Support Frame

6795 21	Cover Plate - 1 Module - Ice White	352	1/5/30
6795 22	Cover Plate - 2 Module - Ice White	372	1/5/30
6795 23	Cover Plate - 3 Module - Ice White	396	1/20
6795 24	Cover Plate - 4 Module - Ice White	422	1/20
6795 26	Cover Plate - 6 Module - Ice White	766	1/10
6795 28	Cover Plate - 8 Module - Ice White	834	1/10
6795 29	Cover Plate - 2*4 Module - Ice White	1044	1/5

* MRP - Maximum Retail Price Inclusive of all taxes including GST.

Bold Cat.Nos are products normally available with Legrand (India) Stockists. Cat.Nos that are not bold - delivery within 4 - 8 weeks from the date of order. Bold packing quantity is our mandatory packing. Orders to be placed by Legrand (India) Stockist in multiples of the same.

Myrius™ Cover Plates

Cat.Nos	Description	MRP ₹ / Unit	Pack
6795 32	Cover Plate - 12 Module - Ice White	1270	1/5
6795 36	Cover Plate - 16 Module - Ice White	1478	1/5
6795 37	Cover Plate - 16 Module(Big) - Ice White	1566	1/5
6795 38	Cover Plate - 18 Module - Ice White	1694	1/5

Ice Black Cover Plates with Support Frame

6795 41	Cover Plate - 1 Module - Ice Black	352	1/5/30
6795 42	Cover Plate - 2 Module - Ice Black	372	1/5/30
6795 43	Cover Plate - 3 Module - Ice Black	396	1/20
6795 44	Cover Plate - 4 Module - Ice Black	422	1/20
6795 46	Cover Plate - 6 Module - Ice Black	766	1/10
6795 48	Cover Plate - 8 Module - Ice Black	834	1/10
6795 49	Cover Plate - 2*4 Module - Ice Black	1044	1/5
6795 52	Cover Plate - 12 Module - Ice Black	1270	1/5
6795 56	Cover Plate - 16 Module - Ice Black	1478	1/5
6795 57	Cover Plate - 16 Module(Big) - Ice Black	1566	1/5
6795 58	Cover Plate - 18 Module - Ice Black	1694	1/5

Pearl Champagne Cover Plates with Support Frame

6795 61	Cover Plate - 1 Module - Pearl Champagne	480	1/5/30
6795 62	Cover Plate - 2 Module - Pearl Champagne	508	1/5/30
6795 63	Cover Plate - 3 Module - Pearl Champagne	540	1/20
6795 64	Cover Plate - 4 Module - Pearl Champagne	584	1/20
6795 66	Cover Plate - 6 Module - Pearl Champagne	1044	1/10
6795 68	Cover Plate - 8 Module - Horizontal - Pearl Champagne	1140	1/10
6795 69	Cover Plate - 2*4 Module - Vertical - Pearl Champagne	1428	1/5
6795 72	Cover Plate - 12 Module - Pearl Champagne	1728	1/5
6795 76	Cover Plate - 16 Module - Pearl Champagne	2010	1/5
6795 77	Cover Plate - 16 Module(Big) - Pearl Champagne	2134	1/5
6795 78	Cover Plate - 18 Module - Pearl Champagne	2314	1/5

Sonic Silver Cover Plates with Support Frame

6795 81	Cover Plate - 1 Module - Sonic Silver	480	1/5/30
6795 82	Cover Plate - 2 Module - Sonic Silver	508	1/5/30

Myrius™ Cover Plates

Cat.Nos	Description	MRP ₹ / Unit	Pack
6795 83	Cover Plate - 3 Module - Sonic Silver	540	1/20
6795 84	Cover Plate - 4 Module - Sonic Silver	584	1/20
6795 86	Cover Plate - 6 Module - Sonic Silver	1044	1/10
6795 88	Cover Plate - 8 Module - Horizontal - Sonic Silver	1140	1/10
6795 89	Cover Plate - 2*4 Module - Vertical - Sonic Silver	1428	1/5
6795 92	Cover Plate - 12 Module - Sonic Silver	1728	1/5
6795 96	Cover Plate - 16 Module - Sonic Silver	2010	1/5
6795 97	Cover Plate - 16 Module(Big) - Sonic Silver	2134	1/5
679598	Cover Plate - 18 Module - Sonic Silver	2314	1/5

Dark Fade Cover Plates with Support Frame

6796 01	Cover Plate - 1 Module - Dark Fade	480	1/5/30
6796 02	Cover Plate - 2 Module - Dark Fade	508	1/5/30
6796 03	Cover Plate - 3 Module - Dark Fade	540	1/20
6796 04	Cover Plate - 4 Module - Dark Fade	584	1/20
6796 06	Cover Plate - 6 Module - Dark Fade	1044	1/10
6796 08	Cover Plate - 8 Module - Horizontal - Dark Fade	1140	1/10
6796 09	Cover Plate - 2*4 Module - Vertical - Dark Fade	1428	1/5
6796 12	Cover Plate - 12 Module - Dark Fade	1728	1/5
6796 16	Cover Plate - 16 Module - Dark Fade	2010	1/5
6796 17	Cover Plate - 16 Module(Big) - Dark Fade	2134	1/5
6796 18	Cover Plate - 18 Module - Dark Fade	2314	1/5

Ice Graphite Cover Plates with Support Frame

6797 21	Cover Plate - 1 Module - Ice Graphite	352	1/5/30
6797 22	Cover Plate - 2 Module - Ice Graphite	372	1/5/30
6797 23	Cover Plate - 3 Module - Ice Graphite	396	1/20
6797 24	Cover Plate - 4 Module - Ice Graphite	422	1/20
6797 26	Cover Plate - 6 Module - Ice Graphite	766	1/10
6797 28	Cover Plate - 8 Module - Horizontal - Ice Graphite	834	1/10
6797 29	Cover Plate - 2*4 Module - Vertical - Ice Graphite	1046	1/5
6797 32	Cover Plate - 12 Module - Ice Graphite	1264	1/5
6797 36	Cover Plate - 16 Module - Ice Graphite	1476	1/5
6797 37	Cover Plate - 16 Module(Big) - Ice Graphite	1566	1/5
6797 38	Cover Plate - 18 Module - Ice Graphite	1694	1/5

* MRP - Maximum Retail Price Inclusive of all taxes including GST.

Bold Cat.Nos are products normally available with Legrand (India) Stockists. Cat.Nos that are not bold - delivery within 4 - 8 weeks from the date of order. Bold packing quantity is our mandatory packing. Orders to be placed by Legrand (India) Stockist in multiples of the same.

Myrius™ Cover Plates

Cat.Nos	Description	MRP ₹ / Unit	Pack
---------	-------------	--------------------	------

Ice Silk Cover Plates with Support Frame

6797 41	Cover Plate - 1 Module - Ice Silk	352	1/5/30
6797 42	Cover Plate - 2 Module - Ice Silk	372	1/5/30
6797 43	Cover Plate - 3 Module - Ice Silk	396	1/20
6797 44	Cover Plate - 4 Module - Ice Silk	422	1/20
6797 46	Cover Plate - 6 Module - Ice Silk	766	1/10
6797 48	Cover Plate - 8 Module - Horizontal - Ice Silk	834	1/10
6797 49	Cover Plate - 2*4 Module - Vertical - Ice Silk	1046	1/5
6797 62	Cover Plate - 12 Module - Ice Silk	1264	1/5
6797 56	Cover Plate - 16 Module - Ice Silk	1476	1/5
6797 67	Cover Plate Big - 16 Module(Big) - Ice Silk	1566	1/5
6797 68	Cover Plate - 18 Module - Ice Silk	1694	1/5

White Glass Cover Plates with Support Frame

6798 11	Cover Plate - 1 Module - White Glass	1274	1/5/30
6798 12	Cover Plate - 2 Module - White Glass	1296	1/5/30
6798 13	Cover Plate - 3 Module - White Glass	1370	1/20
6798 14	Cover Plate - 4 Module - White Glass	1542	1/20
6798 16	Cover Plate - 6 Module - White Glass	1686	1/10
6798 18	Cover Plate - 8 Module - Horizontal - White Glass	1826	1/10
6798 19	Cover Plate - 2*4 Module - Vertical - White Glass	2232	1/5
6798 22	Cover Plate - 12 Module - White Glass	2842	1/5
6798 26	Cover Plate - 16 Module - White Glass	5022	1/5
6798 28	Cover Plate - 18 Module - White Glass	6226	1/5

Black Glass Cover Plates with Support Frame

6798 31	Cover Plate - 1 Module - Black Glass	1274	1/5/30
6798 32	Cover Plate - 2 Module - Black Glass	1296	1/5/30
6798 33	Cover Plate - 3 Module - Black Glass	1370	1/20
6798 34	Cover Plate - 4 Module - Black Glass	1542	1/20
6798 36	Cover Plate - 6 Module - Black Glass	1686	1/10
6798 38	Cover Plate - 8 Module - Horizontal - Black Glass	1826	1/10

Myrius™ Cover Plates

Cat.Nos	Description	MRP ₹ / Unit	Pack
---------	-------------	--------------------	------

Black Glass Cover Plates with Support Frame

6798 39	Cover Plate - 2*4 Module - Vertical - Black Glass	2232	1/5
6798 42	Cover Plate - 12 Module - Black Glass	2842	1/5
6798 46	Cover Plate - 16 Module - Black Glass	5022	1/5
6798 48	Cover Plate - 18 Module - Black Glass	6226	1/5

Anti-Bacterial Cover Plates with Support Frame

6793 41	Cover Plate - 1 Module - Anti-Bacterial-Classic White	278	20/200
6793 42	Cover Plate - 2 Module - Anti-Bacterial-Classic White	306	20/200
6793 43	Cover Plate - 3 Module - Anti-Bacterial-Classic White	344	10/100
6793 44	Cover Plate - 4 Module - Anti-Bacterial-Classic White	366	10/100
6793 46	Cover Plate - 6 Module - Anti-Bacterial-Classic White	600	5/50
6793 48	Cover Plate - 8 Module - Horizontal - Anti-Bacterial-Classic White	704	5/50
6793 49	Cover Plate - 2*4 Module - Vertical - Anti-Bacterial-Classic White	880	5/25
6793 50	Cover Plate - 9 Module - Anti-Bacterial-Classic White	912	5/50
6793 52	Cover Plate - 12 Module - Anti-Bacterial-Classic White	1010	10
6793 56	Cover Plate - 16 Module - Anti-Bacterial-Classic White	1196	10
6793 58	Cover Plate - 18 Module - Anti-Bacterial-Classic White	1334	10

Metal Flush Boxes

6890 07	Metal Flush Box - 1/2 Module	170	40
6890 08	Metal Flush Box - 3 Module	170	40
6890 09	Metal Flush Box - 4 Module	226	40
6890 10	Metal Flush Box - 6 Module	358	40
6890 42	Metal Flush Box - 8 Module	416	40
6890 31	Metal Flush Box - 2*4 Module	414	20
6890 29	Metal Flush Box - 9 Module	490	20
6890 11	Metal Flush Box - 12/16 Module	624	10
6890 12	Metal Flush Box - 18/24 Module	788	10

* MRP - Maximum Retail Price Inclusive of all taxes including GST.

Bold Cat.Nos are products normally available with Legrand (India) Stockists. Cat.Nos that are not bold - delivery within 4 - 8 weeks from the date of order. Bold packing quantity is our mandatory packing. Orders to be placed by Legrand (India) Stockist in multiples of the same.

Myrius™ Mounting Boxes

Cat.Nos	Description	MRP* ₹ / Unit	Pack
---------	-------------	---------------------	------

Plastic Surface Boxes

6733 02	Plastic Surface Box - 1/2 Module	100	10/50
6733 03	Plastic Surface Box - 3 Module	114	5/35
6733 04	Plastic Surface Box - 4 Module	134	5/25
6733 06	Plastic Surface Box - 6 Module	172	1/10
6733 08	Plastic Surface Box - 8 Module	254	1/5
6733 05	Plastic Surface Box - 2*4 Module	240	1/5

Metal Surface Boxes

6890 21	Metal Surface Box - 12 Module (2 Rows*6)	600	1/6
6890 22	Metal Surface Box - 18 Module (3 Rows*6)	634	1/4

Myrius™

Guarantee

- The Company, at its discretion, will replace products if they have any manufacturing defect within 10 years for switches (without LED lamp) and power sockets. For all other **Myrius™** wiring accessories the guarantee will be 2 years.
- The above guarantee is applicable when the devices are used in Legrand metal flush boxes. Otherwise the guarantee period will be reduced by 50%.
- The guarantee is only applicable when the products are installed as per the Company's instructions and not tampered in any manner.
- The guarantee states the Company's entire liability. It does not extend to cover consequential loss or damage or installation costs arising from defective products.

Our switches are compliant with revised BIS standard (IS 3854:2023) requirements. Also, our switches are covered additionally for use on Self-Ballasted Lamp (SBL) loads.

SBL power rating as per IS3854:2023

Switch Rating	6A, 230V~	10A, 230V~	16A, 230V~	20A, 230V~
SBL power (Watt)	100 W	100 W	200 W	250 W

* MRP - Maximum Retail Price Inclusive of all taxes including GST.

Bold Cat.Nos are products normally available with Legrand (India) Stockists. Cat.Nos that are not bold - delivery within 4 - 8 weeks from the date of order. Bold packing quantity is our mandatory packing. Orders to be placed by Legrand (India) Stockist in multiples of the same.

Mylinc™

A little touch of genius

Reliable Modular Wiring for Devices



Mylinc™ is a modular wiring accessories range designed and manufactured in India for residential and commercial installations. Combining dependable mechanisms with practical design, it delivers reliability, convenience, and aesthetically consistent electrical solutions.

Features

- Durable mechanisms tested for up to 1 lakh operations
- Installer-friendly design with Linc-Loc™ alignment, front removal, and orientation indicators
- Enhanced safety with finger-proof IP20 terminals and shuttered sockets
- Quality assurance and laser markings, ISI and CE certification

Benefits

- Ensures long-term reliability with certified and durable components
- Simplifies installation with alignment aids and easy access mechanisms
- Enhances electrical safety through protected terminals and compliant designs
- Supports modern spaces with integrated power, lighting, and connectivity solutions

Scan to know more about the product.

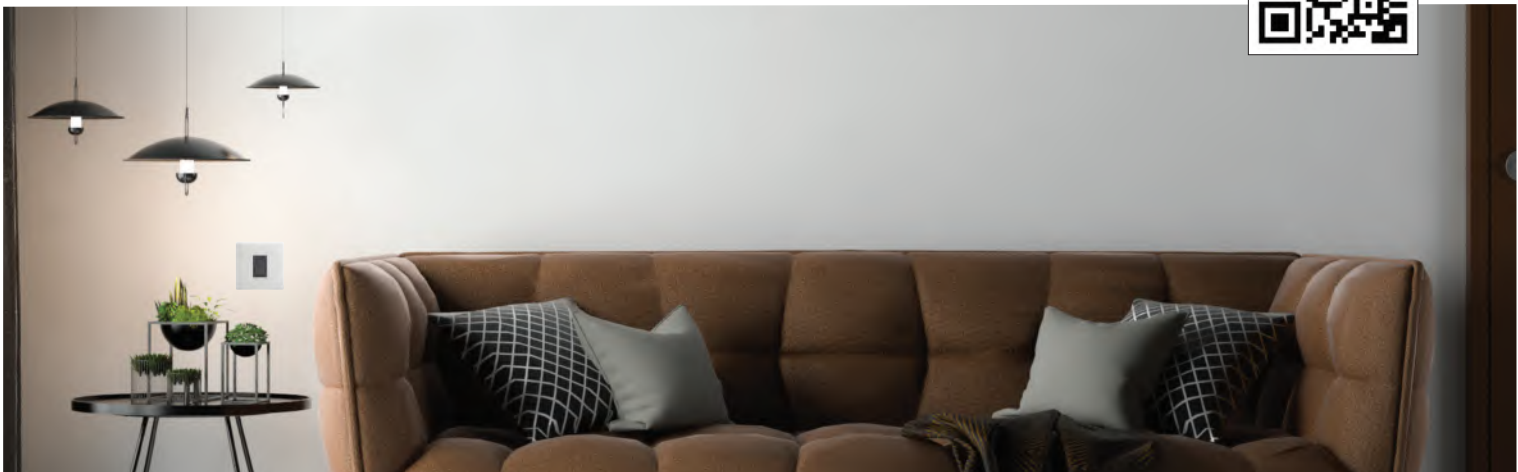

Product Range



Silver Alu



Pearl White



Dark Bronze



Matt Grey



White



Champagne

Myline™ White- Mechanism

Cat.Nos	Description	MRP* ₹ / Unit	Pack
---------	-------------	------------------	------

Switches and Accessories

Switches 6A - 230V AC

6755 01	6A - Switch - SP - 1 Way - 1 Module	112	20/400
6755 02	6A - Switch - SP - 2 Way - 1 Module	226	20/200
6755 03	6A - Switch - SP - 1 Way - with Indicator - 1 Module	254	20/200

Switches - 10A - 230V AC

6755 85	10A - Switch - 1 Way - 1 Module	122	20/400
675593	10A - Switch - 2 Way - 1 Module	236	20/200
675594	10A - Switch - 1 Way - with Indicator - 1 Module	266	20/200

Switches 16A - 230V AC

6755 11	16A - Switch - SP - 1 Way - 1 Module	256	20/200
6755 12	16A - Switch - SP - 2 Way - 1 Module	322	20/200
6755 13	16A - Switch - SP - 1 Way - with Indicator - 1 Module	336	20/200

Switch 25A - 230V AC

6759 68	25A - Switch - with Indicator - 1 Module	518	10/100
---------	--	-----	--------

Switches 32A - 230V AC

6755 26	32A - Switch - DP - 1 Way - with Indicator - 2 Module	764	10/100
---------	---	-----	--------

Push buttons 6A - 230V AC

6755 04	6A - Bell Push - SP - 1 Way - 1 Module	236	20/200
6755 06	6A - Bell Push - SP - 1 Way - with Indicator - 2 Module	468	10/100

Indian Standard Sockets

6755 51	6A - Socket - with Shutter - 3 Pin - ISI - 2 Module	310	20/200
6755 55	6/16A - Socket - with Shutter - 3 Pin - Combine - ISI - 2 Module	476	20/200

Bell Call Indicator & Register - 6A - 230V AC

6755 07	6A - Bell Call Indicator - SP - with Register - 1 Way - 1 Module	1378	20/200
---------	--	------	--------

Lighting Modules

6755 95	Indicator Light Red - 1 Module	326	20/200
6755 96	Indicator Light Orange - 1 Module	326	20/200

Skirting Light

6755 97	Skirting Light - with White LED - 3 Module	1044	10/100
6759 76	Skirting Light - with White LED - 2 Module	696	5/50

Myline™ White- Mechanism

Cat.Nos	Description	MRP* ₹ / Unit	Pack
---------	-------------	------------------	------

Dimmers and Fan Regulators

6755 35	Rotative Dimmer - 60/250 Watts - for Light - 2 Module	868	10/100
6755 33	Dimmer - 400 Watts - for Light - 1 Module	1102	1/5/50
6755 31	Fan Regulator - 100 Watts - Humfree - 0 - 4 Step - 1 Module	794	1/5/50
6759 64	Fan Regulator - 100 Watts - with 360° Rotation - ISI - 2 Module	986	10/100
6755 30	Fan Regulator - 100 Watts - Humfree - 0 - 4 Step - ISI - 2 Module	1062	10/100
6759 77	Fan Regulator - 8 Step ISI - 2 Module	1062	1/10/100
6759 78	Fan Regulator - BLDC - 2 Module [^]	1082	10/100

Buzzer

6755 40	Buzzer - 1 Module	786	20/200
---------	-------------------	-----	--------

Remote Unit

6759 75	Remote Control Unit with Remote - for 4 Switch & Fan Load - 4 Module	5370	1/5/20
---------	--	------	--------

Hospitality function

Hotel "DND and MMR" functions

6759 69	External DND & MMR Control Unit - with Bell Push - 2 Module	492	10/100
6755 57	Internal DND & MMR Control Unit - 2 Module	406	1/10/100

Hotel Keycard Switch

6755 60	15A Key Card Switch - 2 Module	4470	1/10
6730 38	Key Fob for Key Card Switch	298	1/10/100

Motor Starter

6759 65	16A - Motor Starter - 2 Module	848	1/10/100
---------	--------------------------------	-----	----------

Modular MCB (IS : 60898-1:2002)

6759 74	16A - SP - Modular MCB - 1 Module	562	1/10/100
6756 40	20A - SP - Modular MCB - 1 Module	562	1/10/100
6756 41	25A - SP - Modular MCB - 1 Module	562	1/10/100
6756 42	32A - SP - Modular MCB - 1 Module	562	1/10/100

Tv Sockets

6755 46	TV Co - axial Socket - 1 Module	264	20/200
---------	---------------------------------	-----	--------

* MRP - Maximum Retail Price Inclusive of all taxes including GST.

[^]Compatible with Atomberg (Efficio), Havells (Efficiencia neo), Orient (Aerostorm) as per 2023 fan models.

Bold Cat.Nos are products normally available with Legrand (India) Stockists. Cat.Nos that are not bold - delivery within 4 - 8 weeks from the date of order. Bold packing quantity is our mandatory packing. Orders to be placed by Legrand (India) Stockist in multiples of the same.

Mylic™

White- Mechanism

Cat.Nos	Description	MRP* ₹ / Unit	Pack
---------	-------------	------------------	------

Data and Voice

6755 41	Telephone Socket - RJ11 - 1 Module	248	20/200
6755 44	Telephone Socket - Double RJ11 - 1 Module	416	20/200
6759 66	Information Socket - RJ45 - Cat 5E -UTP-with Shutter - 1 Module	562	20/200
6759 67	Information Socket - RJ45 - Cat 6 - UTP-with Shutter - 1 Module	818	20/200
675982	Information Socket - RJ45 - Cat 6A - STP with shutter - 1 Module	929	20/200

USB Chargers (IS13252(Part 1) / IEC 60950-1)

6758 20	USB Charger - 1500mA - Type A - 1 Module	1412	10/100
6755 80	Double USB Charger - 3000mA - Type A + C - 2 Module	3084	1/10/100
6757 95	USB Charger - Power Delivery - 30 Watts - Type C + C - 2 Module	6720	1/3/30
6757 96	USB Charger - Power Delivery - 45 Watts - Type C - 2 Module	8408	1/3/30

Accessories

6755 91	Cable Outlet - 8mm - 1 Module	224	20/200
6755 90	Blanking Plate - 1 Module	64	20/200
6755 92	Spare 12 Screws with Nuts	80	20/200

Modular Cover Plates with Support Frame

White Cover Plates with Support Frame

6755 61	Cover Plate + Support Frame - 1 Module - White	186	20/200
6755 62	Cover Plate + Support Frame - 2 Module - White	186	20/200
6755 63	Cover Plate + Support Frame - 3 Module - White	254	10/100
6755 64	Cover Plate + Support Frame - 4 Module - White	282	10/100
6755 66	Cover Plate + Support Frame - 6 Module - White	350	5/50
6755 67	Cover Plate + Support Frame - Horizontal - 8 Module - White	450	5/50
6755 68	Cover Plate + Support Frame - 2*4 Module - Vertical - White	458	1/25
6755 69	Cover Plate + Support Frame - 9 Module - White	538	5/50
6755 72	Cover Plate + Support Frame - 12 Module - White	660	10
6755 73	Cover Plate + Support Frame - 16 Module - White	770	10
6755 78	Cover Plate + Support Frame - 18 Module - White	1030	10

* MRP - Maximum Retail Price Inclusive of all taxes including GST.

Mylic™

Matt Grey- Mechanism

Cat.Nos	Description	MRP* ₹ / Unit	Pack
---------	-------------	------------------	------

Switches – 6A - 230V AC

6763 01	6A - Switch - SP - 1 Way - 1 Module	132	20/200
6763 02	6A - Switch - SP - 2 Way - 1 Module	244	20/200
6763 03	6A - Switch - SP - 1 Way - with Indicator - 1 Module	286	20/200

Switches – 16A - 230V AC

6763 11	16A - Switch - SP - 1 Way - 1 Module	282	20/200
6763 12	16A - Switch - SP - 2 Way - 1 Module	350	20/200
6763 13	16A - Switch - SP - 1 Way - with Indicator - 1 Module	380	20/200

Switches – 25A - 230V AC

6763 41	25A - Switch - with Indicator - 1 Module	598	10/100
---------	--	-----	--------

Switches – 32A - 230V AC

6763 26	32A - Switch - DP - 1 Way - with Indicator - 2 Module	850	10/100
---------	---	-----	--------

Push Buttons – 6A - 230V AC

6763 04	6A - Bell Push - SP - 1 Way - 1 Module	256	20/200
6763 06	6A - Bell Push - SP - 1 Way - with Indicator - 2 Module	520	10/100

Indian Standard Sockets

6763 27	6A - Socket - with Shutter - 3 Pin - ISI - 2 Module	344	20/200
6763 05	6/16A - Socket - with Shutter - 3 Pin - Combine - ISI - 2 Module	512	20/200

Bell Call Indicator & Register - 6A - 230V AC

6763 07	6A - Bell Call Indicator - SP - with Register - 1 Way - 1 Module	1520	20/200
---------	--	------	--------

Lighting Modules

6763 14	Indicator Light Red - 1 Module	356	20/200
6763 15	Indicator Light Orange - 1 Module	356	20/200

Skirting Light

6763 16	Skirting Light - with White LED - 3 Module	1142	10/100
6763 10	Skirting Light - with White LED - 2 Module	770	5/50

Bold Cat.Nos are products normally available with Legrand (India) Stockists. Cat.Nos that are not bold - delivery within 4 - 8 weeks from the date of order. Bold packing quantity is our mandatory packing. Orders to be placed by Legrand (India) Stockist in multiples of the same.



6755 44



6759 66



6759 67



675982



6758 20



6755 80



6757 95



6757 96



6755 91



6755 90



6755 92



6755 61



6755 62



6755 63



6755 64



6763 01



6763 02



6763 03



6763 11



6763 12



6763 13



6763 41



6763 26



6763 04



6763 06



6763 27



6763 05



6763 07



6763 14



6763 15



6763 16

Myline™ Matt Grey- Mechanism

Cat.Nos	Description	MRP* ₹ / Unit	Pack
Dimmers and Fan Regulators			
6763 17	Rotative Dimmer - 60/250 Watts - for Light - 2 Module	958	10/100
6763 18	Rotative Dimmer - 60/400 Watts - 1 Module	1220	1/5/50
6763 20	Fan Regulator - 100 Watts - Humfree - 0 - 4 Step - 1 Module	868	1/5/50
6763 37	Fan Regulator - 100 Watts - with 360° Rotation - ISI - 2 Module	1084	10/100
6763 19	Fan Regulator - 100 Watts - Humfree - 0 - 4 Step - ISI - 2 Module	1166	10/100
6763 08	Fan Regulator - 8 Step - ISI - 2 Module	1162	1/10/100
6763 09	Fan Regulator - BLDC - 2 Module^	1184	10/100

Buzzer

6763 21	Buzzer - 1 Module	964	20/200
---------	-------------------	-----	--------

Remote Unit

6763 47	Remote Control Unit with Remote - for 4 Switch & Fan Load - 4 Module	5908	1/5/20
---------	--	------	--------

Hospitality Function

Hotel "DND and MMR" functions

6763 42	External DND & MMR Control Unit - with Bell Push - 2 Module	540	10/100
6763 23	Internal DND & MMR Control Unit - 2 Module	472	10/100

Hotel Keycard Switch

6736 24	15A Key Card Switch - 2 Module	4960	1/10
673038	Key Fob for Key Card Switch	298	1/10/100

Protection Devices

Motor Starter

6763 38	16A - Motor Starter - 2 Module	938	1/10/100
---------	--------------------------------	-----	----------

Modular MCB (IS : 60898-1:2002)

6763 46	16A - SP - Modular MCB - 1 Module	628	1/10/100
---------	-----------------------------------	-----	----------

Tv Sockets

6763 32	TV Co - axial Socket - 1 Module	302	20/200
---------	---------------------------------	-----	--------

* MRP - Maximum Retail Price Inclusive of all taxes including GST.
^Compatible with Atomberg (Efficio), Havells (Efficiencia neo), Orient (Aerostorm) as per 2023 fan models.

Myline™ Matt Grey- Mechanism

Cat.Nos	Description	MRP* ₹ / Unit	Pack
Data and Voice			
6763 33	Telephone Socket - RJ11 - 1 Module	270	20/200
6763 34	Telephone Socket - Double RJ11 - 1 Module	446	20/200
6763 39	Information Socket - RJ45 - Cat 5E -UTP-with Shutter - 1 Module	603	20/200
6763 40	Information Socket - RJ45 - Cat 6 - UTP-with Shutter - 1 Module	924	20/200
675983	Information Socket - RJ45 - Cat 6A - STP with shutter - 1 Module	1072	20/200

USB Chargers (IS13252(Part 1) / IEC 60950-1)

6758 21	USB Charger - 1500mA - Type A - 1 Module	1554	10/100
6764 80	Double USB Charger - 3000mA - Type A + C - 2 Module	3538	1/10/100
6766 56	USB Charger - Power Delivery - 30 Watts - Type C + C - 2 Module	7232	1/3/30
6766 57	USB Charger - Power Delivery - 45 Watts - Type C - 2 Module	9402	1/3/30

Accessories

6763 48	Cable Outlet - 8mm - 1 Module	256	20/200
6763 49	Blanking Plate - 1 Module	72	20/200

Bold Cat.Nos are products normally available with Legrand (India) Stockists. Cat.Nos that are not bold - delivery within 4 - 8 weeks from the date of order. Bold packing quantity is our mandatory packing. Orders to be placed by Legrand (India) Stockist in multiples of the same.

Mylinc™ Cover Plate

Cat.Nos	Description	MRP* ₹ / Unit	Pack
Modular Cover Plates with Support Frame			
Matt Grey Cover Plates with Support Frame			
6763 50	Cover Plate + Support Frame - 1 Module - Matt Grey	242	20/200
6763 51	Cover Plate + Support Frame - 2 Module - Matt Grey	242	20/200
6763 52	Cover Plate + Support Frame - 3 Module - Matt Grey	340	10/100
6763 53	Cover Plate + Support Frame - 4 Module - Matt Grey	358	10/100
6763 54	Cover Plate + Support Frame - 6 Module - Matt Grey	456	5/50
6763 55	Cover Plate + Support Frame - 8 Module - Horizontal - Matt Grey	588	5/50
6763 56	Cover Plate + Support Frame - 2*4 Module - Vertical - Matt Grey	602	5/25
6763 57	Cover Plate + Support Frame - 9 Module - Matt Grey	700	5/50
6763 58	Cover Plate + Support Frame - 12 Module - Matt Grey	854	10
6763 59	Cover Plate + Support Frame - 18 Module - Matt Grey	1354	10

Pearl White Cover Plates with Support Frame

6763 60	Cover Plate + Support Frame - 1 Module - Pearl White	230	10/100
6763 61	Cover Plate + Support Frame - 2 Module - Pearl White	230	10/100
6763 62	Cover Plate + Support Frame - 3 Module - Pearl White	304	10/100
6763 63	Cover Plate + Support Frame - 4 Module - Pearl White	332	10/100
6763 64	Cover Plate + Support Frame - 6 Module - Pearl White	436	5/50
6763 65	Cover Plate + Support Frame - 8 Module - Horizontal - Pearl White	550	5/50
6763 66	Cover Plate + Support Frame - 2*4 Module - Vertical - Pearl White	562	5/25
6763 67	Cover Plate + Support Frame - 9 Module - Pearl White	644	5/50
6763 68	Cover Plate + Support Frame - 12 Module - Pearl White	794	5/25
6763 69	Cover Plate + Support Frame - 18 Module - Pearl White	1244	5/25

Mylinc™ Cover Plate

Cat.Nos	Description	MRP* ₹ / Unit	Pack
Champagne Cover Plates with Support Frame			
6763 70	Cover Plate + Support Frame - 1 Module - Champagne	230	10/100
6763 71	Cover Plate + Support Frame - 2 Module - Champagne	230	10/100
6763 72	Cover Plate + Support Frame - 3 Module - Champagne	304	10/100
6763 73	Cover Plate + Support Frame - 4 Module - Champagne	332	10/100
6763 74	Cover Plate + Support Frame - 6 Module - Champagne	436	5/50
6763 75	Cover Plate + Support Frame - 8 Module - Horizontal - Champagne	550	5/50
6763 76	Cover Plate + Support Frame - 2*4 Module - Vertical - Champagne	562	5/25
6763 77	Cover Plate + Support Frame - 9 Module - Champagne	644	5/50
6763 78	Cover Plate + Support Frame - 12 Module - Champagne	794	5/25
6763 79	Cover Plate + Support Frame - 18 Module - Champagne	1244	5/25

Silver Alu Cover Plates with Support Frame

6763 80	Cover Plate + Support Frame - 1 Module - Silver Alu	230	10/100
6763 81	Cover Plate + Support Frame - 2 Module - Silver Alu	230	10/100
6763 82	Cover Plate + Support Frame - 3 Module - Silver Alu	304	10/100
6763 83	Cover Plate + Support Frame - 4 Module - Silver Alu	332	10/100
6763 84	Cover Plate + Support Frame - 6 Module - Silver Alu	436	5/50
6763 85	Cover Plate + Support Frame - 8 Module - Horizontal - Silver Alu	550	5/50
6763 86	Cover Plate + Support Frame - 2*4 Module - Vertical - Silver Alu	562	5/25
6763 87	Cover Plate + Support Frame - 9 Module - Silver Alu	644	5/50
6763 88	Cover Plate + Support Frame - 12 Module - Silver Alu	794	5/25
6763 89	Cover Plate + Support Frame - 18 Module - Silver Alu	1244	5/25

* MRP - Maximum Retail Price Inclusive of all taxes including GST.

Bold Cat.Nos are products normally available with Legrand (India) Stockists. Cat.Nos that are not bold - delivery within 4 - 8 weeks from the date of order. Bold packing quantity is our mandatory packing. Orders to be placed by Legrand (India) Stockist in multiples of the same.

Myline™ Cover Plate

Cat.Nos	Description	MRP* ₹ / Unit	Pack
Dark Bronze Cover Plates with Support Frame			
6763 90	Cover Plate + Support Frame - 1 Module - Dark Bronze	230	10/100
6763 91	Cover Plate + Support Frame - 2 Module - Dark Bronze	230	10/100
6763 92	Cover Plate + Support Frame - 3 Module - Dark Bronze	304	10/100
6763 93	Cover Plate + Support Frame - 4 Module - Dark Bronze	332	10/100
6763 94	Cover Plate + Support Frame - 6 Module - Dark Bronze	436	5/50
6763 95	Cover Plate + Support Frame - 8 Module - Horizontal - Dark Bronze	550	5/50
6763 96	Cover Plate + Support Frame - 2*4 Module - Vertical - Dark Bronze	562	5/25
6763 97	Cover Plate + Support Frame - 9 Module - Dark Bronze	644	5/50
6763 98	Cover Plate + Support Frame - 12 Module - Dark Bronze	794	5/25
6763 99	Cover Plate + Support Frame - 18 Module - Dark Bronze	1244	5/25

Modular White Surrounds

6755 81	Modular Surrounds - 1 Module - White	60	20/200
6755 82	Modular Surrounds - 2 Module - White	96	20/200
6755 83	Modular Surrounds - 3 Module - White	96	10/100
6755 84	Modular Surrounds - 4 Module - White	148	10/100
6755 86	Modular Surrounds - 6 Module - White	216	10/100
6755 89	Modular Surrounds - 9 Module - White	368	10/100

Myline™ Boxes

Cat.Nos	Description	MRP* ₹ / Unit	Pack
Accessories			
Metal Flush Boxes			
6890 07	Metal Flush Box - 1/2 Module	170	40
6890 08	Metal Flush Box - 3 Module	170	40
6890 09	Metal Flush Box - 4 Module	226	40
6890 10	Metal Flush Box - 6 Module	358	40
6890 42	Metal Flush Box - 8 Module	416	40
6890 31	Metal Flush Box - 2*4 Module	414	20
6890 29	Metal Flush Box - 9 Module	490	20
6890 11	Metal Flush Box - 12/16 Module	624	10
6890 13	Metal Flush Box - 16 Module	720	10
6890 12	Metal Flush Box - 18 Module	788	10

Plastic Surface Boxes

6733 02	Plastic Surface Box - 1/2 Module	100	10/50
6733 03	Plastic Surface Box - 3 Module	114	5/35
6733 04	Plastic Surface Box - 4 Module	134	5/25
6733 06	Plastic Surface Box - 6 Module	172	1/10
6733 08	Plastic Surface Box - 8 Module	254	1/5
6733 05	Plastic Surface Box - 2*4 Module	240	1/5
6740 99	Plastic Surface Box - 9 Module	286	1/5

Metal Surface Boxes

6890 21	Metal Surface Box - 12 Module (2 Rows*6)	600	1/6
6890 22	Metal Surface Box - 18 Module (3 Rows*6)	634	1/4

* MRP - Maximum Retail Price Inclusive of all taxes including GST.

Bold Cat.Nos are products normally available with Legrand (India) Stockists. Cat.Nos that are not bold - delivery within 4 - 8 weeks from the date of order. Bold packing quantity is our mandatory packing. Orders to be placed by Legrand (India) Stockist in multiples of the same.

MylicTM

A little touch of genius

A LITTLE TOUCH OF GENIUS



Guarantee

- The Company, at its discretion, will replace products if they have any manufacturing defect within 10 years for switches (without LED lamp) and power sockets. For all other **MylicTM** wiring accessories the guarantee will be 2 years.
- The above guarantee is applicable when the devices are used in Legrand metal flush boxes. Otherwise the guarantee period will be reduced by 50%.
- The guarantee is only applicable when the products are installed as per the Company's instructions and not tampered in any manner.
- The guarantee states the Company's entire liability. It does not extend to cover consequential loss or damage or installation costs arising from defective products.

Our switches are compliant with revised BIS standard (IS 3854:2023) requirements. Also, our switches are covered additionally for use on Self-Ballasted Lamp (SBL) loads.

SBL power rating as per IS3854:2023

Switch Rating	6A, 230V~	10A, 230V~	16A, 230V~	20A, 230V~
SBL power (Watt)	100 W	100 W	200 W	250 W

LyncusTM

Upgrade to new

Elevate Your Home Experience



LyncusTM is a contemporary modular wiring range designed for modern homes. With minimalist styling and versatile modules for power, control, and connectivity, it delivers practical solutions for everyday electrical needs.

Features

- Smart aesthetics with a signature notch that defines modern minimalism
- Switch range from 6–32A with indicator options
- Universally adaptable modules covering lighting, sockets, BLDC Fan regulator, USB charging, data communication, hospitality, and more.
- High durability design rated for long operational life cycles

Benefits

- Ensures dependable performance with high-quality engineering and long-term reliability
- Enhances interiors with a sleek and contemporary design
- Simplifies installation with user-friendly, tool-free fitting
- Enables design customization with a range of premium colour finishes

Scan to know more about the product.

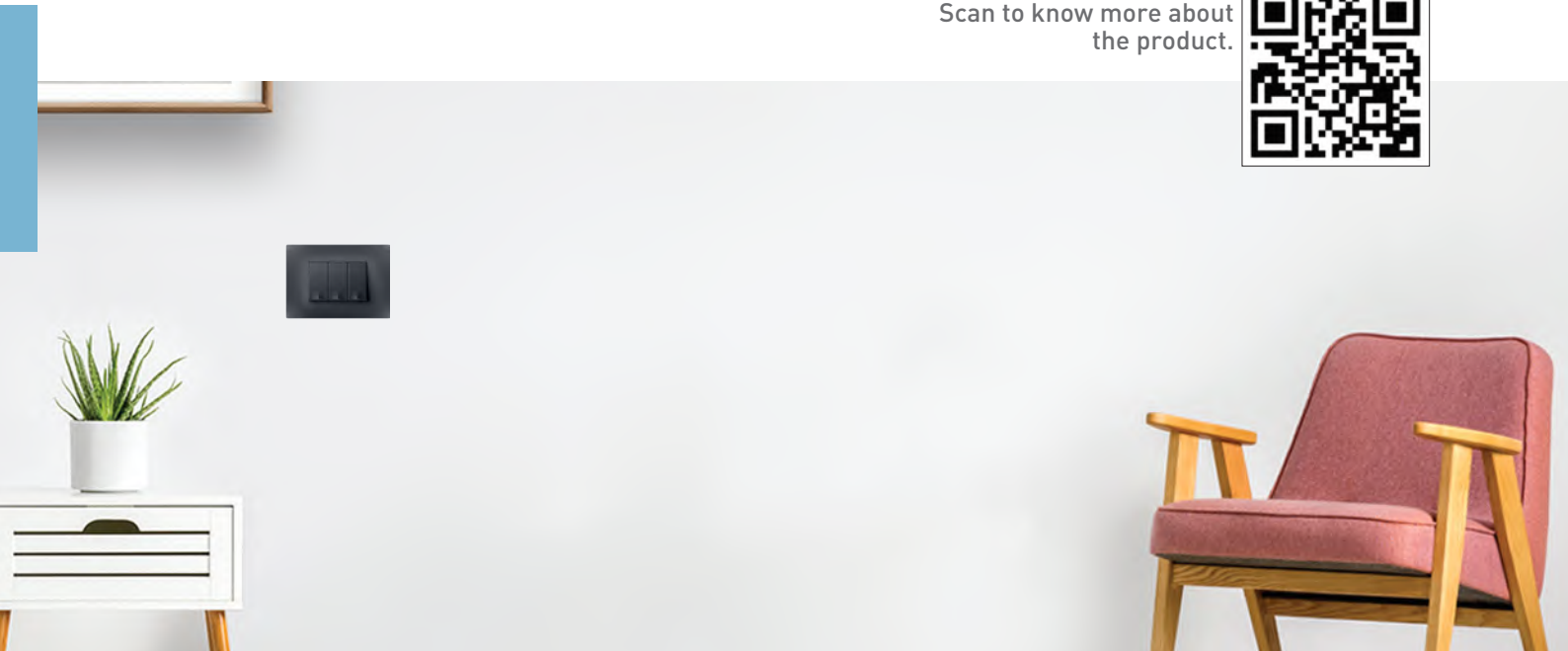

Lyncus^M

Upgrade to new

Upgrade Your Home

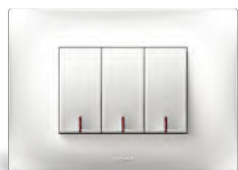

White



Brushed Silver



Alu Sunset



Champagne



Matt Silver



USB Type C
- 20W PD
Fast Charging



USB Type A + C
- 15W



USB Type C + C
- 30W PD
Fast Charging



Remote Control Unit



Bluetooth Sound
Receiver



6/16A Socket
with Shutter (ISI)



Touch Fan
Regulator



Universal
Touch Dimmer

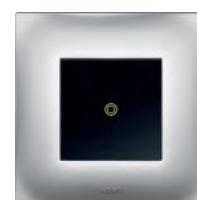

One Way
Touch Switch

Lyncus™

White Mechanism

Cat.Nos	Description	MRP* ₹ / Unit	Pack
---------	-------------	------------------	------

Switches - 6A - 230V AC

6772 00	6A - Switch - 1 Way - 1 Module	98	20/200
6772 01	6A - Switch - 2 Way - 1 Module	204	20/200
6772 02	6A - Switch - 1 Way - with Indicator - 1 Module	204	20/200
6772 03	6A - Switch - 1 Way - with "Light" Marking - 1 Module	184	20/200
6772 04	6A - Switch - 1 Way - with "Fan" Marking - 1 Module	184	20/200

Switches - 10A - 230V AC

6773 01	10A - Switch - 1 Way - 1 Module	106	20/200
6773 02	10A - Switch - 2 Way - 1 Module	208	20/200
6773 07	10A - Switch - 1 Way - with Indicator - 1 Module	208	20/200
6772 05	10A - Switch - 1 Way - 2 Module	244	10/100
6772 06	10A - Switch - 2 Way - 2 Module	292	10/100
6772 07	10A - Intermediate Switch - 2 Module	1666	10/100
6772 08	10A - Switch - 1 Way - with Indicator - 2 Module	320	10/100

Switches - 16A - 230V AC

6772 09	16A - Switch - 1 Way - 1 Module	236	20/200
6772 10	16A - Switch - 2 Way - 1 Module	290	20/200
6772 11	16A - Switch - 1 Way - with Indicator - 1 Module	300	20/200

Switches - 20A - 230V AC

6772 12	20A - Switch - 1 Way - 1 Module	346	20/200
6772 13	20A - Switch - DP - 1 Way - 2 Module	502	10/100
6772 14	20A - Switch - DP - 1 Way - with Indicator - 2 Module	512	10/100
6772 15	20A - Switch - 2 Way - 2 Module	568	10/100

Switches - 25A - 230V AC

6772 16	25A - Switch - SP - 1 Way - with Indicator - 1 Module	358	20/200
---------	---	-----	--------

Switches - 32A - 230V AC

6772 17	32A - Switch - DP - with Indicator - 2 Module	690	10/100
---------	---	-----	--------

Push Button - 6A - 230V AC

6772 18	6A - Push Button - SP - 1 Module	168	20/200
6772 19	6A - Push Button - SP - with Indicator - 1 Module	240	20/200
6772 20	6A - Bell Push - 1 Module	216	20/200
6772 21	6A - Bell Push - with Indicator - 1 Module	254	20/200
6772 22	6A - Bell Push - 2 Module	290	10/100
6772 23	6A - Bell Push - with Indicator - 2 Module	432	10/100

Accessory for Switch with Indicator

6772 24	LED Indicator for Switches	54	5/50
---------	----------------------------	----	------

Lyncus™

White Mechanism

Cat.Nos	Description	MRP* ₹ / Unit	Pack
---------	-------------	------------------	------

Indian Standard Sockets

6772 35	6A - Socket - with Shutter - 3 Pin - ISI - 2 Module	202	20/200
6772 30	6/16A - Socket - with Shutter - ISI - 2 Module	410	20/200
6772 29	6/16A - Socket - with Shutter - ISI - 3 Module	488	5/50
6772 26	16A - Switch + Socket - with Shutter - 3 Pin - 3 Module	772	5/50

Dimmers & Fan Regulators

6772 36	Rotary Light Dimmer - 400 Watts - 1 Module	742	5/50
6772 37	Rotary Light Dimmer - 500 Watts - 2 Module	952	10/100
6772 39	Fan Regulator - 100 Watts - ISI - 1 Module	680	5/50
6772 42	Fan step Regulator - 70 Watts - ISI - 2 Module	920	1/10/100
6772 40	Fan Regulator - 100 Watts - 360° - ISI - 2 Module	844	10/100
6772 41	Fan Regulator - 120 Watts - 360° - ISI - 2 Module	960	10/100
6772 44	Fan Regulator - 8 Step - 100 Watts - ISI - 2 Module	752	10/100
6772 45	Fan Regulator - BLDC - 2 Module [^]	924	10/100

Emergency Light

6772 43	Emergency Removable LED Lamp - 2 Module	3212	20/200
---------	---	------	--------

Skirting Light

6772 48	Skirting Light - with LED - 3 Module	666	10/100
---------	--------------------------------------	-----	--------

Indicator

6772 97	Indicator Unit - with Transparent LED & Colored Labels - 1 Module	470	10/100
---------	---	-----	--------

Bell Call Indicator

6772 49	Bell Call Indicator - 240V - 1 Module	1314	20/200
---------	---------------------------------------	------	--------

Buzzer

6772 50	Buzzer - 230V - 1 Module	752	20/200
---------	--------------------------	-----	--------

Infrared Sensors

6772 51	Infrared Sensor Switch - 400 Watts - 2 Module	1714	20/200
---------	---	------	--------

Remote Unit

6772 52	Remote Control Unit - for Light & Fan - 4 Module	5218	1/5/20
6773 03	Remote Control Hand Unit	838	1/5/30

Hospitality Function

Hotel Keycard Switch

6772 53	15A - Key Card Switch - 2 Module	4150	1/10
6772 55	Key Fob for Key Card Switch	140	10/100

Hotel "DND and MMR" Functions

6772 56	External DND & MMR Control Unit - with Bell Push - 2 Module	460	10/100
6772 57	Internal DND & MMR Control Unit - 2 Module	386	10/100

* MRP - Maximum Retail Price Inclusive of all taxes including GST.

[^] Compatible with Atomberg (Efficio), Havells (Efficiencia neo), Orient (Aerostorm) as per 2023 fan models.

Red Cat. Nos - New Products

Bold Cat.Nos are products normally available with Legrand (India) Stockists. Cat.Nos that are not bold - delivery within 4 - 8 weeks from the date of order. Bold packing quantity is our mandatory packing. Orders to be placed by Legrand (India) Stockist in multiples of the same.

Lyncus™

White Mechanism

Cat.Nos	Description	MRP* ₹ / Unit	Pack
---------	-------------	------------------	------

Shaver socket

6772 58	Shaver Socket - 120/240V - MonoBlock with Plate - 2 Module	3182	20/200
---------	--	------	--------

Sockets & Connectors

Tv Sockets

6772 60	TV Co - axial Socket - 1 Module	230	20/200
---------	---------------------------------	-----	--------

Data & voice

6772 62	Telephone Socket - RJ11 - 1 Module	216	20/200
6772 63	Telephone Socket - Double RJ11 - 1 Module	352	20/200
6772 64	Information Socket - RJ45 - Cat 5 - UTP -with Shutter - 1 Module	530	20/200
6772 65	Information Socket - RJ45 - Cat 6 - UTP -with Shutter - 1 Module	740	20/200
6773 20	Information Socket - RJ45 - CAT6A - STP with shutter - 1 Module	942	20/200

Audio Video Connectors

6772 67	Preterminated Audio/Video Connector - 1 Module	1731	1/10
6772 68	Preterminated HDMI Socket - 1 Module	2121	1/10
6772 69	Preterminated Projector Connector - 1 Module	2121	1/10

Sound (Volume controller)

6772 70	Volume Controller - 2 Module	1361	10/100
---------	------------------------------	------	--------

Protectors and Accessories

Motor Starter

6772 71	16A - Motor Starter - 2 Module	796	1/5/50
6772 72	25A - Motor Starter - 2 Module	796	1/5/50

VSP

6772 74	Voltage Surge Protector - 230V - 1 Module	2654	20/200
---------	---	------	--------

Modular MCB (IS : 608981:2002)

6772 81	16A - SP - Modular MCB - 1 Module	546	1/10/100
6772 82	20A - SP - Modular MCB - 1 Module	546	1/10/100
6772 83	32A - SP - Modular MCB - 1 Module	546	1/10/100

Lyncus™

White Mechanism

Cat.Nos	Description	MRP* ₹ / Unit	Pack
---------	-------------	------------------	------

Electronic Function

USB Chargers (IS13252 (Part 1) / IEC 60950-1)

6772 91	USB Charger - 1500mA - Type A - 1 Module	1356	10/100
6772 89	USB Charger - 3000mA - Type A + C - 2 Module	3028	1/10/100
6777 51	USB Charger - 3000mA/15 Watts - Type A - 1 Module	1986	1/5/50
6777 52	USB Charger - 3000mA/15 Watts - Type A + A - 1 Module	2206	1/5/50
6777 53	USB Charger - 3000mA/15 Watts - Type A + C - 1 Module	2526	1/5/50
6777 54	USB Charger - 3000mA/15 Watts - Type C + C - 1 Module	2762	1/5/50
6777 55	USB Charger - Power Delivery - 20 Watts - Type C - 1 Module	3824	1/5/50
6777 56	USB Charger - Power Delivery - 30 Watts - Type C + C - 2 Module	6562	1/3/30
6777 57	USB Charger - Power Delivery - 45W - Type C - 2 Module	8034	1/3/30
NEW! 6777 59	USB Charger - Power Delivery - 65W - Type C + C - 3 Module	9966	1/5/20

Loud Speakers

6772 98	Loudspeaker for False Ceiling & Plaster Board - 8Ohms - 10 Watts	2741	1/6
---------	--	------	-----

Sound Diffusion

6772 99*	Bluetooth Sound Diffusion - 2 Module	6033	1/10/100
----------	--------------------------------------	------	----------

Rotary Dimmer Universal

6773 04	Rotary LED Light Dimmer - 50 Watts - 1 Module	2740	1/10/100
---------	---	------	----------

Touch Switches

6773 09	6A - Touch Switch - 1 Way - 2 Module - Black	3782	1/50
6773 10	6A - Touch Switch - 2 Way - 2 Module - Black	4370	1/50
6773 13	16A - Touch Switch - 1 Way - 2 Module - Black	4370	1/50
6773 06	6A - Touch Bell Push - 2 Module - Black	3782	1/50

Touch Regulator & Dimmer

6773 05	Touch Fan Regulator - 100 Watts - 2 Module - Black	4370	1/50
6773 15	Universal LED Touch Light Scroll Dimming - 300 Watts - 2 Module - Black	4370	1/50

Reading Light

6773 16	Reading Light LED	2524	20/200
---------	-------------------	------	--------

* MRP - Maximum Retail Price Inclusive of all taxes including GST.
Red Cat. Nos - New Products

Bold Cat.Nos are products normally available with Legrand (India) Stockists. Cat.Nos that are not bold - delivery within 4 - 8 weeks from the date of order. Bold packing quantity is our mandatory packing. Orders to be placed by Legrand (India) Stockist in multiples of the same.

Lyncus™

White Mechanism

Cat.Nos	Description	MRP* ₹ / Unit	Pack
---------	-------------	------------------	------

Accessories

6772 75	Cable Outlet - 8mm - 1 Module	208	20/200
6772 76	Blanking Plate - 1 Module - Classic White	54	40/400
6772 77	Blanking Plate - 2 Module - Classic White	70	10/100

Chic Grey- Mechanism

Switches - 6A - 230V AC

6774 00	6A - Switch - 1 Way - 1 Module	118	20/200
6774 01	6A - Switch - 2 Way - 1 Module	236	20/200
6774 02	6A - Switch - 1 Way - with Indicator - 1 Module	238	20/200
6774 03	6A - Switch - 1 Way - with "Light" Marking - 1 Module	226	20/200
6774 04	6A - Switch - 1 Way - with "Fan" Marking - 1 Module	226	20/200

Switches - 10A - 230V AC

6774 05	10A - Switch - 1 Way - 2 Module	288	10/100
6774 06	10A - Switch - 2 Way - 2 Module	338	10/100
6774 07	10A - Intermediate Switch - 2 Module	1918	10/100
6774 08	10A - Switch - 1 Way - with Indicator - 2 Module	372	10/100

Switches - 16A - 230V AC

6774 09	16A - Switch - 1 Way - 1 Module	260	20/200
6774 10	16A - Switch - 2 Way - 1 Module	334	20/200
6774 11	16A - Switch - 1 Way - with Indicator - 1 Module	346	20/200

Switches - 20A - 230V AC

6774 12	20A - Switch - 1 Way - 1 Module	402	20/200
6774 13	20A - Switch - DP - 1 Way - 2 Module	580	10/100
6774 14	20A - Switch - DP - 1 Way - with Indicator - 2 Module	588	10/100
6774 15	20A - Switch - 2 Way - 2 Module	666	10/100

Switches - 25A - 230V AC

6774 16	25A - Switch - SP - 1 Way - with Indicator - 1 Module	414	20/200
---------	---	-----	--------

Switches - 32A - 230V AC

6774 17	32A - Switch - DP - with Indicator - 2 Module	794	10/100
---------	---	-----	--------

Push Button - 6A - 230V AC

6774 18	6A - Push Button - SP - 1 Module	192	20/200
6774 19	6A - Push Button - SP - with Indicator - 1 Module	272	20/200
6774 20	6A - Bell Push - 1 Module	250	20/200
6774 21	6A - Bell Push - with Indicator - 1 Module	296	20/200
6774 22	6A - Bell Push - 2 Module	334	10/100
6774 23	6A - Bell Push - with Indicator - 2 Module	494	10/100

Lyncus™

Chic Grey Mechanism

Cat.Nos	Description	MRP* ₹ / Unit	Pack
---------	-------------	------------------	------

Indian Standard Sockets

6774 35	6A - Socket - with Shutter - 3 Pin - ISI - 2 Module	232	20/200
6774 30	6/16A - Socket - with Shutter - ISI - 2 Module	474	20/200
6774 29	6/16A - Socket - with Shutter - ISI - 3 Module	564	5/50

Dimmers & Fan Regulators

6774 36	Rotary Light Dimmer - 400 Watts - 1 Module	854	5/50
6774 37	Rotary Light Dimmer - 500 Watts - 2 Module	1090	10/100
6774 39	Fan Regulator - 100 Watts - ISI - 1 Module	788	5/50
6774 42	Fan step Regulator - 70 Watts - ISI - 2 Module	1060	1/10/100
6774 40	Fan Regulator - 100 Watts - 360° - ISI - 2 Module	970	10/100
6774 41	Fan Regulator - 120 Watts - 360° - ISI - 2 Module	1102	10/100
6774 44	Fan Regulator - 8 Step - 100 Watts - ISI - 2 Module	880	10/100
6774 45	Fan Regulator - BLDC - 2 Module^	1070	10/100

Skirting Light

6774 48	Skirting Light - with LED - 3 Module	752	10/100
---------	--------------------------------------	-----	--------

Bell Call Indicator

6774 49	Bell Call Indicator - 240V - 1 Module	1482	20/200
---------	---------------------------------------	------	--------

Buzzer

6774 50	Buzzer - 230V - 1 Module	854	20/200
---------	--------------------------	-----	--------

Remote Unit

6774 52	Remote Control Unit - for Light & Fan - 4 Module	5602	1/5/20
6773 03	Remote Control Hand Unit	838	1/5/30

Hospitality Function

Hotel Keycard Switch

6774 53	15A - Key Card Switch - 2 Module	4682	1/10
6772 55	Key Fob for Key Card Switch	140	10/100

Hotel "DND and MMR" Functions

6774 56	External DND & MMR Control Unit - with Bell Push - 2 Module	528	10/100
6774 57	Internal DND & MMR Control Unit - 2 Module	460	10/100

Shaver Socket

6774 58	Shaver Socket - 120/240V - MonoBlock with Plate - 2 Module	3560	20/200
---------	--	------	--------

TV Sockets

6774 60	TV Co - axial Socket - 1 Module	262	20/200
---------	---------------------------------	-----	--------

* MRP - Maximum Retail Price Inclusive of all taxes including GST.

^Compatible with Atomberg (Efficio), Havells (Eficiencia neo), Orient (Aerostorm) as per 2023 fan models.

Bold Cat.Nos are products normally available with Legrand (India) Stockists. Cat.Nos that are not bold - delivery within 4 - 8 weeks from the date of order. Bold packing quantity is our mandatory packing. Orders to be placed by Legrand (India) Stockist in multiples of the same.

Lyncus™

Chic Grey Mechanism

Cat.Nos	Description	MRP* ₹ / Unit	Pack
---------	-------------	------------------	------

Data & Voice

6774 62	Telephone Socket - RJ11 - 1 Module	246	20/200
6774 63	Telephone Socket - Double RJ11 - 1 Module	416	20/200
6774 64	Information Socket - RJ45 - Cat 5 - UTP -with Shutter - 1 Module	580	20/200
6774 65	Information Socket - RJ45 - Cat 6 - UTP -with Shutter - 1 Module	892	20/200
6773 21	Information Socket - RJ45 - CAT6A - STP with shutter - 1 Module	1023	20/200

Audio Video Sockets

6774 67	Preterminated Audio/Video Connector - 1 Module	1994	1/10
6774 68	Preterminated HDMI Socket - 1 Module	2438	1/10
6774 69	Preterminated Projector Connector - 1 Module	2438	1/10

Sound (volume controller)

6774 70	Volume Controller - 2 Module	1572	1/10/100
---------	------------------------------	------	----------

Electronic Function

USB Chargers (IS13252 (Part 1) / IEC 609501)

6774 91	USB Charger - 1500mA - Type A - 1 Module	1540	1/5/50
6774 89	USB Charger - 3000mA - Type A + C - 2 Module	3480	1/10/100
6779 51	USB Charger - 3000mA/15 Watts - Type A - 1 Module	2214	1/5/50
6779 52	USB Charger - 3000mA/15 Watts - Type A + A - 1 Module	2480	1/5/50
6779 53	USB Charger - 3000mA/15 Watts - Type A + C - 1 Module	2808	1/5/50
6779 54	USB Charger - 3000mA/15 Watts - Type C + C - 1 Module	3066	1/5/50
6779 55	USB Charger - Power Delivery - 20 Watts - Type C - 1 Module	4276	1/5/50
6779 56	USB Charger - Power Delivery - 30 Watts - Type C + C - 2 Module	7188	1/3/30
6779 57	USB Charger - Power Delivery - 45W - Type C - 2 Module	8856	1/3/30
NEW! 6779 59	USB Charger - Power Delivery - 65W - Type C + C - 3 Module	10526	1/5/20

Sound Receiver

6774 99*	Bluetooth Sound Diffusion - 2 Module	6941	1/10/100
----------	--------------------------------------	------	----------

Rotary Dimmer Universal

6774 24	Rotary LED Dimmer - 50 Watts - 1 Module	3474	1/120
---------	---	------	-------

Accessories

6774 75	Cable Outlet - 8mm - 1 Module	246	20/200
6774 76	Blanking Plate - 1 Module	58	40/400

Lyncus™

Plate with Support Frame

Cat.Nos	Description	MRP* ₹ / Unit	Pack
---------	-------------	------------------	------

Cover Plates with Support Frame White Cover Plates with Support Frame

6775 01	Cover Plate + Support Frame - 1 Module - Classic White	170	20/200
6775 02	Cover Plate + Support Frame - 2 Module - Classic White	170	20/200
6775 03	Cover Plate + Support Frame - 3 Module - Classic White	218	10/100
6775 04	Cover Plate + Support Frame - 4 Module - Classic White	254	10/100
6775 06	Cover Plate + Support Frame - 6 Module - Classic White	308	5/50
6775 08	Cover Plate + Support Frame - 8 Module - Horizontal - Classic White	394	5/50
6775 09	Cover Plate + Support Frame - 2*4 Module - Vertical - Classic White	412	5/25
6775 10	Cover Plate + Support Frame - 9 Module - Classic White	438	5/50
6775 12	Cover Plate + Support Frame - 12 Module - Classic White	574	10
6775 16	Cover Plate + Support Frame - 16 Module - Classic White	668	10
6776 17	Cover Plate + Support Frame - 16 Module(Big) - Classic White	680	10
6775 18	Cover Plate + Support Frame - 18 Module - Classic White	902	10

* MRP - Maximum Retail Price Inclusive of all taxes including GST.
Red Cat. Nos - New Products









Bold Cat.Nos are products normally available with Legrand (India) Stockists. Cat.Nos that are not bold - delivery within 4 - 8 weeks from the date of order. Bold packing quantity is our mandatory packing. Orders to be placed by Legrand (India) Stockist in multiples of the same.

Lyncus™

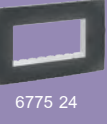
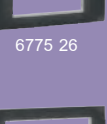
Plate with Support Frame

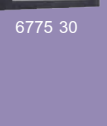
Cat.Nos	Description	MRP* ₹ / Unit	Pack
---------	-------------	---------------------	------

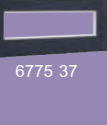
Chic Grey Cover Plates with Support Frame









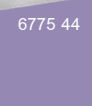
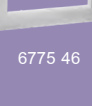

 6775 21	Cover Plate + Support Frame - 1 Module - Chic Grey	218	20/200
 6775 22	Cover Plate + Support Frame - 2 Module - Chic Grey	218	20/200
 6775 23	Cover Plate + Support Frame - 3 Module - Chic Grey	304	10/100
 6775 24	Cover Plate + Support Frame - 4 Module - Chic Grey	322	10/100
 6775 26	Cover Plate + Support Frame - 6 Module - Chic Grey	396	5/50
 6775 28	Cover Plate + Support Frame - 8 Module - Horizontal - Chic Grey	540	5/50
 6775 29	Cover Plate + Support Frame - 2*4 Module - Vertical - Chic Grey	540	5/25
 6775 30	Cover Plate + Support Frame - 9 Module - Chic Grey	582	5/50
 6775 32	Cover Plate + Support Frame - 12 Module - Chic Grey	754	10
 6775 36	Cover Plate + Support Frame - 16 Module - Chic Grey	868	10
 6776 37	Cover Plate + Support Frame - 16 Module (Big) - Chic Grey	874	10
 6775 38	Cover Plate + Support Frame - 18 Module - Chic Grey	1184	10

Lyncus™

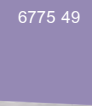
Plate with Support Frame

Cat.Nos	Description	MRP* ₹ / Unit	Pack
---------	-------------	---------------------	------

Brushed Silver Cover Plates with Support Frame

 6775 41	Cover Plate + Support Frame - 1 Module - Brushed Silver	224	20/200
 6775 42	Cover Plate + Support Frame - 2 Module - Brushed Silver	224	20/200
 6775 43	Cover Plate + Support Frame - 3 Module - Brushed Silver	322	10/100
 6775 44	Cover Plate + Support Frame - 4 Module - Brushed Silver	332	10/100
 6775 46	Cover Plate + Support Frame - 6 Module - Brushed Silver	426	5/50
 6775 48	Cover Plate + Support Frame - 8 Module - Horizontal - Brushed Silver	552	5/50
 6775 49	Cover Plate + Support Frame - 2*4 Module - Vertical - Brushed Silver	552	5/25
 6775 50	Cover Plate + Support Frame - 9 Module - Brushed Silver	606	5/50
 6775 52	Cover Plate + Support Frame - 12 Module - Brushed Silver	790	10
 6775 56	Cover Plate + Support Frame - 16 Module - Brushed Silver	914	10
 6776 57	Cover Plate + Support Frame - 16 Module (Big) - Brushed Silver	926	10
 6775 58	Cover Plate + Support Frame - 18 Module - Brushed Silver	1244	10

* MRP - Maximum Retail Price Inclusive of all taxes including GST.

Bold Cat.Nos are products normally available with Legrand (India) Stockists. Cat.Nos that are not bold - delivery within 4 - 8 weeks from the date of order. Bold packing quantity is our mandatory packing. Orders to be placed by Legrand (India) Stockist in multiples of the same.

Lyncus™







Plate with Support Frame

Cat.Nos	Description	MRP* ₹ / Unit	Pack
Alu Sun Set Cover Plates with Support Frame			
 6775 61	Cover Plate + Support Frame - 1 Module - Alu SunSet	220	20/200
 6775 62	Cover Plate + Support Frame - 2 Module - Alu SunSet	220	20/200
 6775 63	Cover Plate + Support Frame - 3 Module - Alu SunSet	304	10/100
 6775 64	Cover Plate + Support Frame - 4 Module - Alu SunSet	330	10/100
 6775 66	Cover Plate + Support Frame - 6 Module - Alu SunSet	418	5/50
 6775 68	Cover Plate + Support Frame - 8 Module - Horizontal - Alu SunSet	540	5/50
 6775 69	Cover Plate + Support Frame - 2*4 Module - Vertical - Alu SunSet	544	5/25
 6775 70	Cover Plate + Support Frame - 9 Module - Alu SunSet	582	5/50
 6775 72	Cover Plate + Support Frame - 12 Module - Alu SunSet	768	10
 6775 76	Cover Plate + Support Frame - 16 Module - Alu SunSet	888	10
 6776 77	Cover Plate + Support Frame - 16 Module(Big) - Alu SunSet	894	10
 6775 78	Cover Plate + Support Frame - 18 Module - Alu SunSet	1220	10

* MRP - Maximum Retail Price Inclusive of all taxes including GST.

Lyncus™

Plate with Support Frame

Cat.Nos	Description	MRP* ₹ / Unit	Pack
Champagne Cover Plates with Support Frame			
 6775 81	Cover Plate + Support Frame - 1 Module - Champagne	220	20/200
 6775 82	Cover Plate + Support Frame - 2 Module - Champagne	220	20/200
 6775 83	Cover Plate + Support Frame - 3 Module - Champagne	304	10/100
 6775 84	Cover Plate + Support Frame - 4 Module - Champagne	330	10/100
 6775 86	Cover Plate + Support Frame - 6 Module - Champagne	418	5/50
 6775 88	Cover Plate + Support Frame - 8 Module - Horizontal - Champagne	540	5/50
 6775 89	Cover Plate + Support Frame - 2*4 Module - Vertical - Champagne	544	5/25
 6775 90	Cover Plate + Support Frame - 9 Module - Champagne	582	5/50
 6775 92	Cover Plate + Support Frame - 12 Module - Champagne	768	10
 6775 96	Cover Plate + Support Frame - 16 Module - Champagne	888	10
 6776 97	Cover Plate + Support Frame - 16 Module(Big) - Champagne	894	10
 6775 98	Cover Plate + Support Frame - 18 Module - Champagne	1220	10

Bold Cat.Nos are products normally available with Legrand (India) Stockists. Cat.Nos that are not bold - delivery within 4 - 8 weeks from the date of order. Bold packing quantity is our mandatory packing. Orders to be placed by Legrand (India) Stockist in multiples of the same.

Lyncus™

Plate with Support Frame

Cat.Nos	Description	MRP* ₹ / Unit	Pack
Matt Silver Cover Plates with Support Frame			
6776 01	Cover Plate + Support Frame - 1 Module - Matt Silver	220	20/200
6776 02	Cover Plate + Support Frame - 2 Module - Matt Silver	220	20/200
6776 03	Cover Plate + Support Frame - 3 Module - Matt Silver	304	10/100
6776 04	Cover Plate + Support Frame - 4 Module - Matt Silver	330	10/100
6776 06	Cover Plate + Support Frame - 6 Module - Matt Silver	418	5/50
6776 08	Cover Plate + Support Frame - 8 Module - Horizontal - Matt Silver	540	5/50
6776 09	Cover Plate + Support Frame - 2*4 Module - Vertical - Matt Silver	544	5/25
6776 10	Cover Plate + Support Frame - 9 Module - Matt Silver	582	5/50
6776 12	Cover Plate + Support Frame - 12 Module - Matt Silver	768	10
6776 16	Cover Plate + Support Frame - 16 Module - Matt Silver	888	10
6776 67	Cover Plate + Support Frame - 16 Module(Big) - Matt Silver	894	10
6776 18	Cover Plate + Support Frame - 18 Module - Matt Silver	1220	10

Accessories

Metal Flush Boxes

6890 07	Metal Flush Box - 1/2 Module	170	40
6890 08	Metal Flush Box - 3 Module	170	40
6890 09	Metal Flush Box - 4 Module	226	40
6890 10	Metal Flush Box - 6 Module	358	40
6890 42	Metal Flush Box - 8 Module	416	40
6890 31	Metal Flush Box - 2*4 Module	414	20
6890 29	Metal Flush Box - 9 Module	490	20
6890 11	Metal Flush Box - 12/16 Module	624	10
6890 13	Metal Flush Box - 16 Module	720	10
6890 12	Metal Flush Box - 18 Module	788	10

* MRP - Maximum Retail Price Inclusive of all taxes including GST.

Lyncus™

Boxes

Cat.Nos	Description	MRP* ₹ / Unit	Pack
---------	-------------	------------------	------

Plastic Surface Boxes

6733 02	Plastic Surface Box - 1/2 Module	100	10/50
6733 03	Plastic Surface Box - 3 Module	114	5/35
6733 04	Plastic Surface Box - 4 Module	134	5/25
6733 06	Plastic Surface Box - 6 Module	172	1/10
6733 08	Plastic Surface Box - 8 Module	254	1/5
6733 05	Plastic Surface Box - 2*4 Module	240	1/5
6740 99	Plastic Surface Box - 9 Module	286	1/5

Metal Surface Boxes

6890 21	Metal Surface Box - 12 Module (2 Rows*6)	600	1/6
6890 22	Metal Surface Box - 18 Module (3 Rows*6)	634	1/4

Bold Cat.Nos are products normally available with Legrand (India) Stockists. Cat.Nos that are not bold - delivery within 4 - 8 weeks from the date of order. Bold packing quantity is our mandatory packing. Orders to be placed by Legrand (India) Stockist in multiples of the same.

LyncusTM

Change to today

Guarantee

- The Company, at its discretion, will replace products if they have any manufacturing defect within 10 years for switches (without LED lamp) and power sockets. For all other **LyncusTM** wiring accessories the guarantee will be 2 years.
- The above guarantee is applicable when the devices are used in Legrand metal flush boxes. Otherwise the guarantee period will be reduced by 50%.
- The guarantee is only applicable when the products are installed as per the Company's instructions and not tampered in any manner.
- The guarantee states the Company's entire liability. It does not extend to cover consequential loss or damage or installation costs arising from defective products.

Our switches are compliant with revised BIS standard (IS 3854:2023 requirements). Also, our switches are covered additionally for use on Self-Ballasted Lamp (SBL) loads.

SBL power rating as per IS3854:2023

Switch Rating	6A, 230V~	10A, 230V~	16A, 230V~	20A, 230V~
SBL power (Watt)	100 W	100 W	200 W	250 W

Allzy™

The All-Rounder Switch Range



Allzy™ is a versatile modular switch range designed for modern Indian homes and workplaces. Combining stylish finishes, versatile modules, and dependable performance, it delivers convenient solutions for power, charging, connectivity, and everyday control.

Features

- Durable switch mechanisms tested for 1 lakh on/off operations
- Comprehensive switch range upto 32A rating with low-noise rockers, regulators and dimmers
- 6A, 6/16A sockets shuttered also offering complete USB charging needs for everyday usage
- Connectivity modules RJ11, RJ45, HDMI, AV and projector sockets
- Convenience & hospitality controls such as remote control units, switches, and MMR modules

Benefits

- Enhances interiors with five stylish plate finishes and dual mechanism colours
- Ensures dependable safety with shuttered sockets, certified components, and durable performance testing
- Enables seamless connectivity for communication, entertainment, and presentations
- Improves convenience through rapid USB charging solutions



Colour Plates:



Scan to know more about the product.

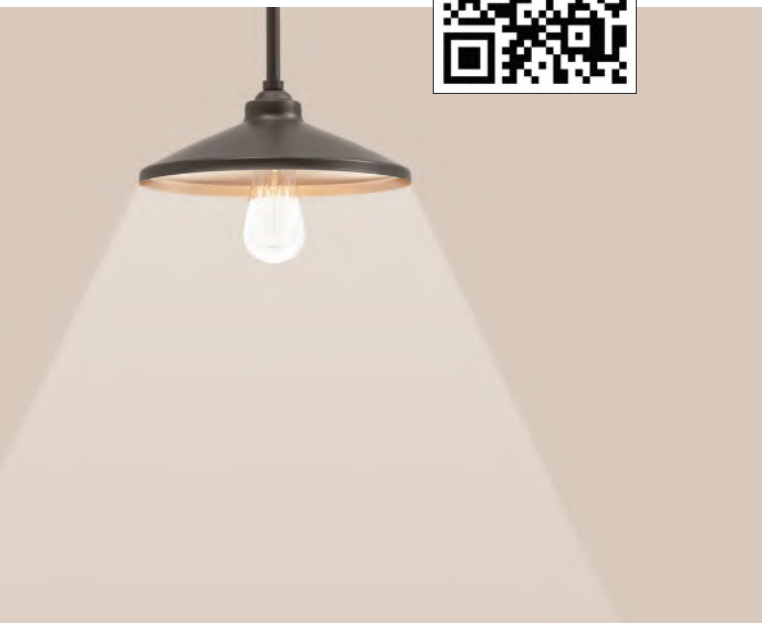

Allzy

The All-rounder Switch

Live the Advantage
of an All-Rounder.

Range

SWITCHES



6A Switch 1W-
Light Marking



6A Switch 1W-
Fan Marking



20A DP Switch 1W-
Indicator Marking



6A Bell Push 1W-
Indicator Marking



Gold- Plate & Frame



Aluminium Champagne-
Plate & Frame



Rose Gold-Plate & Frame



White-Plate & Frame



Matt Black-Plate & Frame

SOCKETS



6A 3 Pin Socket with Shutter
- ISI Mark



6/16A Socket with shutter
- ISI Mark

ELECTRONICS



Fan Regulator 8 step 100W
- ISI Mark



Fan Regulator 360° 100W
- ISI Mark



Rotary Dimmer 500W



Remote Control Unit

USB



Type A + C
3A, 1M

Type A + C 3A, 2M

Type C 20W PD, 1M

Type C + C 30W PD,
2M

Type C 45W PD, 2M*

Type C + C 65W PD, 3M*

**45 & 65W COMPATIBLE FOR LAPTOP CHARGING*

VOICE & DATA COMMUNICATIONS



Double RJ11 Telephone
Socket (with Shutter)

RJ11 Telephone Socket
(with Shutter)

RJ45 Cat6 UTP Socket
(with Shutter)

AUDIO VIDEO CONNECTOR



Preterminated
Audio Video Connector

Preterminated
HDMI Socket

PROTECTION



Power Unit with 20A MCB &
16A Plug

32A Modular MCB DP

16A Motor starter

HOSPITALITY



Key card 15A switch-
Card 230V

32A DP Key tag switch
(Mechanical)

Shaver Socket 120/230V
AC with plate

DND & MMR indicator-
6A bell push (Outside)

DND & MMR (Inside)

Allzy™

White - Mechanism

Cat.Nos	Description	MRP* ₹ / Unit	Pack
---------	-------------	------------------	------

Switches 6A - 230V AC

6811 00	6A - Switch - SP - 1 Way - 1 Module	54	20/400
6811 11	6A - Switch - SP - 2 Way - 1 Module	122	20/200
6811 02	6A - Switch - SP - 1 Way - with Indicator - 1 Module	108	20/200
6811 03	6A - Switch - SP - 1 Way - with "Light" Marking - 1 Module	110	20/200
6811 04	6A - Switch - SP - 1 Way - with "Fan" Marking - 1 Module	110	20/200

Switches - 10A - 230V AC

6811 74	10A - Switch - 1 Way - 1 Module	58	20/200
6811 75	10A - Switch - 2 Way - 1 Module	124	20/200
6811 76	10A - Switch - 1 Way - with Indicator - 1 Module	108	20/200

Switches - 16A - 230V AC

6811 01	16A - Switch - SP - 1 Way - 1 Module	146	20/200
6811 12	16A - Switch - SP - 2 Way - 1 Module	212	20/200
6811 05	16A - Switch - SP - 1 Way - with Indicator - 1 Module	190	20/200

Switches - 20A - 230V AC

6811 07	20A - Switch - SP - 1 Way - 1 Module	174	20/200
6811 08	20A - Switch - SP - 1 Way - with Indicator - 1 Module	230	20/200
6811 13	20A - Switch - SP - 1 Way - with Indicator - 2 Module	262	10/100
6811 15	20A - Switch - DP - 1 Way - with Indicator - 2 Module	268	10/100

Switches - 25A - 230V AC

6811 06	25A - Switch - SP - 1 Way - with Indicator - 1 Module	244	20/200
---------	---	-----	--------

Switches - 32A - 230V AC

6811 16	32A - Switch - DP - 1 Way - with Indicator - 2 Module	356	10/100
---------	---	-----	--------

Push Button - 6A - 230V AC

6811 09	6A - Bell Push - SP - 1 Way - 1 Module	120	20/200
6811 10	6A - Bell Push - SP - 1 Way - with Indicator - 1 Module	146	20/200
6811 14	6A - Bell Push - SP - 1 Way - with Indicator - 2 Module	222	10/100

Accessory for Switch with Indicator

6811 37	LED Indicator for Switch (Red)	50	1/5/50
---------	--------------------------------	----	--------

Indian Standard Sockets

6811 24	6A - Socket - with Shutter - 3 Pin - ISI - 2 Module	188	20/200
6811 22	6/16A - Socket - with Shutter - ISI - 2 Module	270	20/200

Allzy™

White - Mechanism

Cat.Nos	Description	MRP* ₹ / Unit	Pack
---------	-------------	------------------	------

Dimmers & Fan Regulators

6811 43	Rotary Dimmer - 400 Watts - 1 Module	578	5/50
6811 44	Rotary Dimmer - 500 Watts - 2 Module	752	10/100
6811 40	Fan Regulator - 4 Step - 100 Watts - ISI - 1 Module	570	5/50
6811 41	Fan Regulator - 100 Watts - with 360° Rotation - ISI - 2 Module	658	10/100
6811 42	Fan Regulator - 8 Step - 100 Watts - ISI - 2 Module	718	1/10/100
6811 99	Fan Regulator - BLDC - 2 Module ^A	670	1/10/100

Skirting Light

6811 50	Skirting Light - 2 Module	470	10/50
---------	---------------------------	-----	-------

Indicator

6811 38	Flat Indicator Red - 1 Module	190	20/200
---------	-------------------------------	-----	--------

Bell Call Indicator

6811 46	Bell Call Indicator - 1 Module	816	20/200
---------	--------------------------------	-----	--------

Buzzer

6811 39	Buzzer - 230V - 1 Module	364	20/200
---------	--------------------------	-----	--------

Remote Unit

6811 54	Remote Control Unit - for Light & Fan - 4 Module	5126	1/5/20
---------	--	------	--------

Hospitality Function

Hotel Keycard Switch

6811 17	32A - DP - Key Tag Switch (Mechanical) - 2 Module	594	1/10
6811 79	Keytag for (681117) WH	276	10/100
6811 47	15A - Key Card Switch with Key Fob - Monoblock	2864	1/10

Hotel "DND and MMR" Functions

6811 48	Internal DND & MMR Control Unit - 2 Module	370	10/100
6811 49	External DND & MMR Control Unit - with Bell Push - 2 Module	436	10/100

Shaver Socket

6811 55	Shaver Socket - 120V/230V - with Plate - 4 Module	5384	1/5/20
---------	---	------	--------

Tv Sockets

6811 33	TV Co - axial Socket - 1 Module	134	20/200
---------	---------------------------------	-----	--------

Data & Voice

6811 30	Telephone Socket - RJ11 - with Shutter - 1 Module	140	20/200
6811 31	Telephone Socket - Double RJ11 - with Shutter - 1 Module	212	20/200
6811 32	Information Socket - RJ45 - Cat 6 - UTP - with Shutter - 1 Module	729	20/200

Audio Video Connectors

6811 34	Preterminated HDMI Socket - 1 Module	1380	1/10
6811 35	Preterminated Audio/Video Connector - 1 Module	1376	1/10
6811 36	Preterminated Projector Connector - 1 Module	1791	1/10

Sound (Electronic Bell)

6811 45	Electronic Bell - 2 Module	408	10/100
---------	----------------------------	-----	--------

Protectors and Accessories

Motor Starter

6811 66	16A - Motor Starter - 2 Module	666	1/10/100
6811 67	25A - Motor Starter - 2 Module	666	1/10/100

* MRP - Maximum Retail Price Inclusive of all taxes including GST.
^ACompatible with Atomberg (Efficio), Havells (Efficiencia neo), Orient (Aerostorm) as per 2023 fan models.

Bold Cat.Nos are products normally available with Legrand (India) Stockists. Cat.Nos that are not bold - delivery within 4 - 8 weeks from the date of order. Bold packing quantity is our mandatory packing. Orders to be placed by Legrand (India) Stockist in multiples of the same.

Allzy™

White - Mechanism

Cat.Nos	Description	MRP* ₹ / Unit	Pack
---------	-------------	------------------	------

Modular MCB (IS : 608981:2002)

6811 56	6A - Modular MCB - SP - 1 Module	502	1/10/100
6811 57	10A - Modular MCB - SP - 1 Module	502	1/10/100
6811 58	16A - Modular MCB - SP - 1 Module	502	1/10/100
6811 59	20A - Modular MCB - SP - 1 Module	502	1/10/100
6811 60	25A - Modular MCB - SP - 1 Module	502	1/10/100
6811 61	32A - Modular MCB - SP - 1 Module	502	1/10/100
6811 62	16A - Modular MCB - DP - 2 Module	954	1/10/100
6811 63	20A - Modular MCB - DP - 2 Module	954	1/10/100
6811 64	25A - Modular MCB - DP - 2 Module	954	1/10/100
6811 65	32A - Modular MCB - DP - 2 Module	954	1/10/100

Power Unit

6811 27	Power Unit with 20A SP MCB & 16A Plug - 3 Module	1484	1/10
6811 28	Power Unit with 25A SP MCB & 16A Plug - 3 Module	1588	1/10

Electronic Function

USB Chargers (IS13252 (Part 1) / IEC 60950-1)

6811 52	USB Charger - 1500mA - Type A - 1 Module	1116	10/100
6811 51	USB Charger - 3000mA - Type A+ A - 2 Module	1782	10/100
6811 70	USB Charger - 3000mA - Type A + C - 2 Module	2164	10/100
6811 80	USB Charger - 3000mA/15 Watts - Type A - 1 Module	1740	1/5/50
6811 81	USB Charger - 3000mA/15 Watts - Type A + A - 1 Module	1918	1/5/50
6811 82	USB Charger - 3000mA/15 Watts - Type A + C - 1 Module	2446	1/5/50
6811 83	USB Charger - 3000mA/15 Watts - Type C + C - 1 Module	2670	1/5/50
6811 84	USB Charger - Power Delivery - 20 Watts - Type C - 1 Module	3244	1/5/50
6811 85	USB Charger - Power Delivery - 30 Watts - Type C + C - 2 Module	6158	1/3/30
6811 86	USB Charger - Power Delivery - 45 Watts - Type C - 2 Module	7756	1/3/30
NEW! 6811 96	USB Charger - Power Delivery - 65 Watts - Type C + C - 3 Module	9824	1/5/20

Accessories

6811 68	Cable Outlet - 8MM - 1 Module	112	20/200
6811 69	Blanking Plate - 1 Module	34	40/400

Matt Black Mechanism

Switches 6A - 230 V AC

6812 00	6A - Switch - SP - 1 Way - 1 Module	58	20/400
6812 11	6A - Switch - SP - 2 Way - 1 Module	138	20/200
6812 02	6A - Switch - SP - 1 Way - with Indicator - 1 Module	118	20/200
6812 03	6A - Switch - SP - 1 Way - with "Light" Marking - 1 Module	124	20/200
6812 04	6A - Switch - SP - 1 Way - with "Fan" Marking - 1 Module	124	20/200

Allzy™

Matt Black - Mechanism

Cat.Nos	Description	MRP* ₹ / Unit	Pack
---------	-------------	------------------	------

Switches 16A - 230 V AC

6812 01	16A - Switch - SP - 1 Way - 1 Module	166	20/200
6812 12	16A - Switch - SP - 2 Way - 1 Module	242	20/200
6812 05	16A - Switch - SP - 1 Way - with Indicator - 1 Module	220	20/200

Switches 20A - 230V AC

6812 07	20A - Switch - SP - 1 Way - 1 Module	204	20/200
6812 08	20A - Switch - SP - 1 Way - with Indicator - 1 Module	268	20/200
6812 13	20A - Switch - SP - 1 Way - with Indicator - 2 Module	300	10/100
6812 15	20A - Switch - DP - 1 Way - with Indicator - 2 Module	300	10/100

Switches 25A - 230 V AC

6812 06	25A - Switch - SP - 1 Way - with Indicator - 1 Module	276	20/200
---------	---	-----	--------

Switches 32A - 230 V AC

6812 16	32A - Switch - DP - 1 Way - with Indicator - 2 Module	410	10/100
---------	---	-----	--------

Push Button 6A - 230 V AC

6812 09	6A - Bell Push - SP - 1 Way - 1 Module	136	20/200
6812 10	6A - Bell Push - SP - 1 Way - with Indicator - 1 Module	166	20/200
6812 14	6A - Bell Push - SP - 1 Way - with Indicator - 2 Module	256	10/100

Indian Standard Sockets

6812 24	6A - Socket - with Shutter - 3 Pin - ISI - 2 Module	226	20/200
6812 22	6/16A - Socket - with Shutter - ISI - 2 Module	306	20/200

Dimmers & Fan Regulators

6812 43	Rotary Dimmer - 400 Watts - 1 Module	662	5/50
6812 44	Rotary Dimmer - 500 Watts - 2 Module	858	10/100
6812 40	Fan Regulator - 4 Step - 100 Watts - ISI - 1 Module	660	5/50
6812 41	Fan Regulator - 100 Watts - with 360° Rotation - ISI - 2 Module	750	10/100
6812 42	Fan Regulator - 8 Step - 100 Watts - ISI - 2 Module	848	1/10/100
6812 99	Fan Regulator - BLDC - 2 Module^	764	10/100

Skirting Light

6812 50	Skirting Light - 2 Module	536	1/10/50
---------	---------------------------	-----	---------

Indicator

6812 38	Flat Indicator Red - 1 Module	210	20/200
---------	-------------------------------	-----	--------

Buzzer

6812 39	Buzzer - 230V - 1 Module	414	20/200
---------	--------------------------	-----	--------

Remote Unit

6812 54	Remote Control Unit - for Light & Fan - 4 Module	5440	1/5/20
---------	--	------	--------

Hospitality Function

Hotel Keycard Switch

6812 17	32A - DP - Key Tag Switch (Mechanical) - 2 Module	676	1/10
6812 79	Keytag for (681217) MB	310	10/100
6812 47	15A - Key Card Switch with Key Fob - Monoblock	3598	1/10

Hotel "DND and MMR" Functions

6812 48	Internal DND & MMR Control Unit - 2 Module	456	10/100
6812 49	External DND & CMR Control Unit - with Bell Push - 2 Module	516	10/100

* MRP - Maximum Retail Price Inclusive of all taxes including GST.

^Compatible with Atomberg (Efficio), Havells (Efficiencia neo), Orient (Aerostorm) as per 2023 fan models.

Red Cat.Nos - new products

Bold Cat.Nos are products normally available with Legrand (India) Stockists. Cat.Nos that are not bold - delivery within 4 - 8 weeks from the date of order. Bold packing quantity is our mandatory packing. Orders to be placed by Legrand (India) Stockist in multiples of the same.

Allzy™

Matt Black - Mechanism

Cat.Nos	Description	MRP* ₹ / Unit	Pack
---------	-------------	------------------	------

Shaver Socket

6812 55	Shaver Socket - 120V/230V - with Plate - 4 Module	6140	1/5/20
---------	---	------	--------

Tv Sockets

6812 33	TV Co - axial Socket - 1 Module	154	20/200
---------	---------------------------------	-----	--------

Data & Voice

6812 30	Telephone Socket - RJ11 - with Shutter - 1 Module	166	20/200
6812 31	Telephone Socket - Double RJ11 - with Shutter - 1 Module	236	20/200
6812 32	Information Socket - RJ45 - Cat 6 - UTP - with Shutter - 1 Module	857	20/200

Audio Video Connectors

6812 34	Preterminated HDMI Socket - 1 Module	1571	1/10
6812 35	Preterminated Audio/Video Connector - 1 Module	1570	1/10
6812 36	Preterminated Projector Connector - 1 Module	2040	1/10

Protectors & Accessories

Motor Starter

6812 66	16A - Motor Starter - 2 Module	766	1/10/100
6812 67	25A - Motor Starter - 2 Module	766	1/10/100

Modular MCB (IS : 608981:2002)

6812 56	6A - Modular MCB - SP - 1 Module	572	1/10/100
6812 57	10A - Modular MCB - SP - 1 Module	572	1/10/100
6812 58	16A - Modular MCB - SP - 1 Module	572	1/10/100
6812 59	20A - Modular MCB - SP - 1 Module	572	1/10/100
6812 60	25A - Modular MCB - SP - 1 Module	572	1/10/100
6812 61	32A - Modular MCB - SP - 1 Module	572	1/10/100

Power Unit

6812 27	Power Unit with 20A SP MCB & 16A Plug - 3 Module	1688	1/10
6812 28	Power Unit with 25A SP MCB & 16A Plug - 3 Module	1812	1/10

Electronic Function

USB Chargers (IS13252 (Part 1) / IEC 60950-1)

6812 52	USB Charger - 1500mA - Type A - 1 Module	1402	10/100
6812 51	USB Charger - 3000mA - Type A + A - 2 Module	2072	10/100
6812 70	USB Charger - 3000mA - Type A + C - 2 Module	2470	10/100
6812 80	USB Charger - 3000mA/15 Watts - Type A - 1 Module	1918	1/5/50
6812 81	USB Charger - 3000mA/15 Watts - Type A + A - 1 Module	2124	1/5/50
6812 82	USB Charger - 3000mA/15 Watts - Type A + C - 1 Module	2644	1/5/50
6812 83	USB Charger - 3000mA/15 Watts - Type C + C - 1 Module	2892	1/5/50
6812 84	USB Charger - Power Delivery - 20 Watts - Type C - 1 Module	3656	1/5/50
6812 85	USB Charger - Power Delivery - 30 Watts - Type C + C - 2 Module	6630	1/3/30
6812 86	USB Charger - Power Delivery - 45 Watts - Type C - 2 Module	8552	1/3/30
NEW! 6812 96	USB Charger - Power Delivery - 65 Watts - Type C + C - 3 Module	10474	1/5/20

* MRP - Maximum Retail Price Inclusive of all taxes including GST.
Red Cat. Nos - New Products

Allzy™

Matt Black - Mechanism

Cat.Nos	Description	MRP* ₹ / Unit	Pack
---------	-------------	------------------	------

Accessories

6812 68	Cable Outlet - 8MM - 1 Module	128	20/200
6812 69	Blanking Plate - 1 Module	40	40/400

Cover Plates with Support Frame

White Cover Plates with Support Frame

6813 00	Cover Plate + Frame - 1 Module - White	144	20/200
6813 01	Cover Plate + Frame - 2 Module - White	144	20/200
6813 02	Cover Plate + Frame - 3 Module - White	204	10/100
6813 03	Cover Plate + Frame - 4 Module - White	216	10/100
6813 04	Cover Plate + Frame - 6 Module - White	296	5/50
6813 05	Cover Plate + Frame - 8 Module - Horizontal-White	362	5/50
6813 06	Cover Plate + Frame - 2*4 Module - Vertical-White	362	5/25
6813 07	Cover Plate + Frame - 9 Module - White	420	5/50
6813 08	Cover Plate + Frame - 12 Module - White	520	10
6813 09	Cover Plate + Frame - 16 Module - White	556	10
6813 10	Cover Plate + Frame - 18 Module - White	594	10

Matt Black Cover Plates With Support Frame

6813 11	Cover Plate with Frame - 1 Module - Matt Black	184	20/200
6813 12	Cover Plate with Frame - 2 Module - Matt Black	184	20/200
6813 13	Cover Plate with Frame - 3 Module - Matt Black	242	10/100
6813 14	Cover Plate with Frame - 4 Module - Matt Black	278	10/100
6813 15	Cover Plate with Frame - 6 Module - Matt Black	378	5/50
6813 16	Cover Plate with Frame - 8 Module - Horizontal-Matt Black	416	5/50
6813 17	Cover Plate with Frame - 2*4 Module - Vertical-Matt Black	416	5/25
6813 18	Cover Plate with Frame - 9 Module - Matt Black	502	5/50
6813 19	Cover Plate with Frame - 12 Module - Matt Black	606	10
6813 20	Cover Plate with Frame - 16 Module - Matt Black	690	10
6813 21	Cover Plate with Frame - 18 Module - Matt Black	734	10

Gold Cover Plates with Support Frame

6813 33	Cover Plate with Frame - 1 Module - Gold	194	20/200
6813 34	Cover Plate with Frame - 2 Module - Gold	194	20/200
6813 35	Cover Plate with Frame - 3 Module - Gold	262	10/100
6813 36	Cover Plate with Frame - 4 Module - Gold	284	10/100
6813 37	Cover Plate with Frame - 6 Module - Gold	420	5/50
6813 38	Cover Plate with Frame - 8 Module - Horizontal-Gold	468	5/50
6813 39	Cover Plate with Frame - 2*4 Module - Vertical-Gold	468	5/25
6813 40	Cover Plate with Frame - 9 Module - Gold	562	5/50
6813 41	Cover Plate with Frame - 12 Module - Gold	676	10
6813 42	Cover Plate with Frame - 16 Module - Gold	734	10
6813 43	Cover Plate with Frame - 18 Module - Gold	778	10

Bold Cat.Nos are products normally available with Legrand (India) Stockists. Cat.Nos that are not bold - delivery within 4 - 8 weeks from the date of order. Bold packing quantity is our mandatory packing. Orders to be placed by Legrand (India) Stockist in multiples of the same.

Allzy™

Cover Plates

Cat.Nos	Description	MRP* ₹ / Unit	Pack
---------	-------------	------------------	------

Aluminium Champagne Cover Plates with Support Frame

6813 44	Cover Plate with Frame - 1 Module - Aluminium Champagne	194	20/200
6813 45	Cover Plate with Frame - 2 Module - Aluminium Champagne	194	20/200
6813 46	Cover Plate with Frame - 3 Module - Aluminium Champagne	262	10/100
6813 47	Cover Plate with Frame - 4 Module - Aluminium Champagne	284	10/100
6813 48	Cover Plate with Frame - 6 Module - Aluminium Champagne	420	5/50
6813 49	Cover Plate with Frame - 8 Module - Horizontal- Aluminium Champagne	468	5/50
6813 50	Cover Plate with Frame - 2*4 Module - Vertical- Aluminium Champagne	468	5/25
6813 51	Cover Plate with Frame - 9 Module - Aluminium Champagne	562	5/50
6813 52	Cover Plate with Frame - 12 Module - Aluminium Champagne	676	10
6813 53	Cover Plate with Frame - 16 Module - Aluminium Champagne	734	10
6813 54	Cover Plate with Frame - 18 Module - Aluminium Champagne	778	10

Rose Gold Cover Plates with Support Frame

6813 55	Cover Plate with Frame - 1 Module - Rose Gold	194	20/200
6813 56	Cover Plate with Frame - 2 Module - Rose Gold	194	20/200
6813 57	Cover Plate with Frame - 3 Module - Rose Gold	262	10/100
6813 58	Cover Plate with Frame - 4 Module - Rose Gold	284	10/100
6813 59	Cover Plate with Frame - 6 Module - Rose Gold	420	5/50
6813 60	Cover Plate with Frame - 8 Module - Horizontal-Rose Gold	468	5/50
6813 61	Cover Plate with Frame - 2*4 Module - Vertical-Rose Gold	468	5/25
6813 62	Cover Plate with Frame - 9 Module - Rose Gold	562	5/50
6813 63	Cover Plate with Frame - 12 Module - Rose Gold	676	10
6813 64	Cover Plate with Frame - 16 Module - Rose Gold	734	10
6813 65	Cover Plate with Frame - 18 Module - Rose Gold	778	10

* MRP - Maximum Retail Price Inclusive of all taxes including GST.

Allzy™

Mounting Boxes

Cat.Nos	Description	MRP* ₹ / Unit	Pack
---------	-------------	------------------	------

Accessories

Metal Flush Boxes

6890 60	Metal Flush Box - 1 & 2 Module	88	40
6890 61	Metal Flush Box - 3 Module	116	40
6890 62	Metal Flush Box - 4 Module	140	40
6890 63	Metal Flush Box - 6 Module	222	40
6890 65	Metal Flush Box - 8 Module	278	40
6890 64	Metal Flush Box - 8 (2 Rows*4) Module	278	20
6890 66	Metal Flush Box - 12 (2 Rows*6) Module	386	10
6890 67	Metal Flush Box - 16 (2 Rows*8) Module	436	10
6890 68	Metal Flush Box - 18 Module	498	10

Plastic Surface Boxes

6890 70	Plastic Surface Box - 1 & 2 Module	70	50
6890 71	Plastic Surface Box - 3 Module	86	35
6890 72	Plastic Surface Box - 4 Module	112	25
6890 73	Plastic Surface Box - 6 Module	168	10
6813 70	Plastic Surface Box - 8 Module	254	10
6890 74	Plastic Surface Box - 8 (2 Rows*4) Module	230	10
6890 76	Plastic Surface Box - 12 (2 Rows*6) Module	280	10
6890 77	Plastic Surface Box - 16 (2 Rows*8) Module	330	10

Metal Surface Box

6890 78	Metal Surface Box - 18 Module	350	10
---------	-------------------------------	-----	----

Our switches are compliant with revised BIS standard (IS 3854:2023 requirements). Also, our switches are covered additionally for use on Self-Ballasted Lamp (SBL) loads.

SBL power rating as per IS3854:2023

Switch Rating	6A, 230V~	10A, 230V~	16A, 230V~	20A, 230V~
SBL power (Watt)	100 W	100 W	200 W	250 W

Bold Cat.Nos are products normally available with Legrand (India) Stockists. Cat.Nos that are not bold - delivery within 4 - 8 weeks from the date of order. Bold packing quantity is our mandatory packing. Orders to be placed by Legrand (India) Stockist in multiples of the same.

Workstation Power and Data Solutions

Flexible Power and Data Access for Modern Workspaces

Legrand Workstation Solutions provide a complete and integrated approach to power and data distribution for modern office environments. Combining floor boxes, raised and screed floor systems, pop-up desk units, and perimeter trunking, the range is designed to deliver seamless connectivity, organized cable management, and flexible workstation layouts. Engineered for both performance and aesthetics, these solutions ensure easy installation, scalability, and adaptability to evolving workspace needs—making them ideal for dynamic offices, commercial spaces, and collaborative environments.

Features

- Comprehensive solution for power, AV & data distribution
- Compatible with perimeter, desk, raised access floors and screed floor systems
- Designed for fast installation with high reliability, robustness, and flexibility
- Engineered for strength, supporting superior load capacities for demanding environments

Benefits

- Ensures organized and efficient power and data distribution across office spaces
- Enables flexible workstation layouts with easily accessible floor and desk outlets
- Improves workspace aesthetics with concealed and flush-mounted installations
- Supports scalable infrastructure for high-density workstation environments and future expansion



Alongside the Incara™ range, Legrand provides additional workspace solutions such as trunking systems, raised floor boxes, metal and aluminium floor outlets, desk grommets, and underfloor distribution to support scalable office infrastructure.

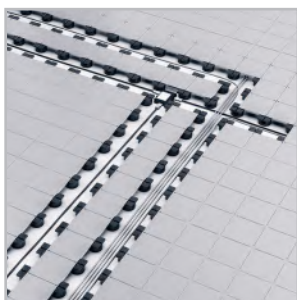

Soluflex cable floor system



Raceways : PVC & Metal (GI)

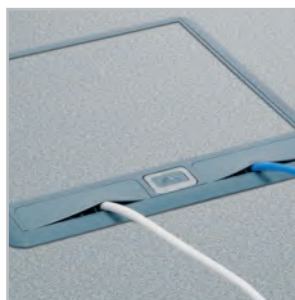

Floor boxes



Dlp trunking system:
Snap-on, Mini & PVC, Aluminium

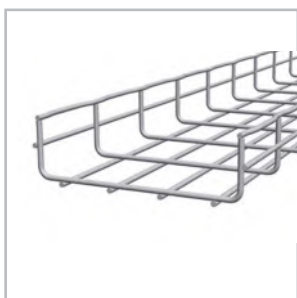

Cablofil wire mesh cable trays

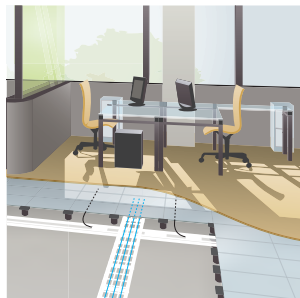

Raised access floor systems



Screed floor system



Wall and ceiling systems

Scan to know more about the product.



Incara Top Access

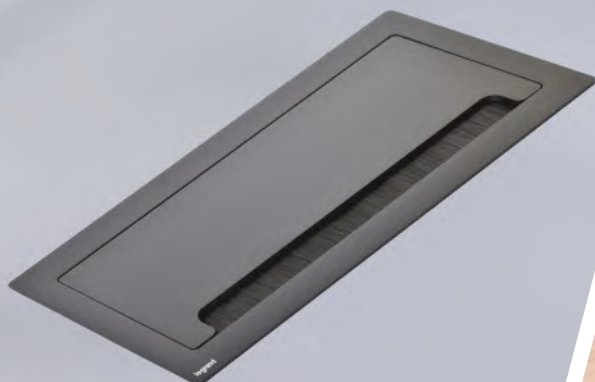

Disq 80



Disq 60

INCARA™ Pop-up Box

Elegant Design with Seamless Connectivity



Incara™ Pop-up provides convenient access to power, data, and charging for laptops, smartphones, tablets, and AV equipment directly at the workspace. Its patented design integrates discreetly into furniture, offering smooth damper operation and premium finishes that blend seamlessly with modern interiors.

Features

- Extra-slim pop-up design compatible with 15–40 mm desktops
- Multiple module configurations available in 3, 4, 8, and 2x4 formats. Also available 4 module in IP44 option
- Premium finishes including White, Black, Aluminium, and Brushed Aluminium
- Compatible with 250+ Arteor & Advance modules, including USB-C PD up to 63/65W

Benefits

- Improves workspace efficiency with easy access to power and connectivity
- Maintains a clean desk aesthetic with discreet, flush integration into furniture
- Ensures reliable daily use with robust construction and protection options
- Adapts to evolving technology needs through modular configuration and fast charging support

Now Available with
Arteor™ Advance Modules



Scan to know more about
the product.



INCARA™ Flip-up Box

Elegant Connectivity for Premium Meeting Rooms



Incara™ Flip-up is a premium tabletop connectivity solution designed for modern meeting rooms. Its fully metal construction and patented push-to-open mechanism allow the unit to rise smoothly while the cover slides discreetly inside even with devices plugged in providing seamless access to power, data, and AV connections.

Features

- Patented push-to-open flip mechanism with smooth, dual-sided access
- Robust all-metal construction with premium finish
- Quick, tool-free installation for 15–40 mm desktops
- Pre-equipped Arteor modules including sockets, USB-C charging, HDMI, and RJ45

Benefits

- Enhances meeting room aesthetics with discreet, integrated connectivity
- Improves collaboration through easy access to power and data from both sides
- Reduces installation time with fast and secure mounting design
- Supports modern AV setups with versatile power, data, and charging options



Now Available with
Arteor™ Advance Modules

Scan to know more about
the product.



INCARA™ Top Access

Discreet Cable Management for Meeting Tables



Incara™ Top Access provides a practical solution for organizing power modules and cables beneath meeting tables. With a flush-mounted lid and integrated storage basket, it keeps worktops clear while allowing easy access to chargers, power strips, and connectivity modules in modern meeting and collaboration spaces.

Features

- Integrated metal storage basket for power strips and excess cabling
- Two width options: 295 mm and 385 mm for different table sizes
- Premium finishes: White, Black, and Metal to match furniture styles
- Flush-mount lid with soft-close damper for 10–40 mm desktops

Benefits

- Keeps meeting tables organised by concealing cables and adapters
- Maintains a clean, professional workspace appearance
- Simplifies cable routing with dedicated under-desk storage
- Supports flexible integration with office power and connectivity modules



Scan to know more about the product.

Incara™ Flip up

Cat.Nos	Description	MRP* ₹ / Unit	Pack
---------	-------------	------------------	------

Max. power: 3680 W at 230 VA
 6A switch d IS 3854 : 1997
 6A sockets IS 1293: 2019
 USB IEC 60950 1
 IS 13252(Part 1)
 Protection IK 07 & IP 30
 For flush mounting in furniture,
 Compatible for desk thickness 15 to 40
Incara™ Flip up Pre Equipped (Arteor Advance)

6540 24	Flip-up 8M SW 2 SKT USB C+C 1 HDMI	37480	1
6540 25	Flip-up 8M SW 2 SKT USB C+C 1 RJ45 1 HDMI	38376	1
6540 26	Flip-up 12M SW 4 SKT USB C+C 1 HDMI	41476	1
6540 27	Flip-up 12M SW 4 SKT USB C+C 1 RJ45 1 HDMI	42338	1

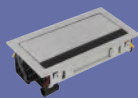

6540 24

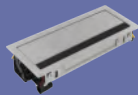

6540 27

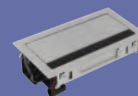

6540 22

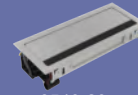

6540 23

Incara™ Flip Up (Empty)

To be equipped version of the Incara Flip up is compatible with Arteor Advance accessories, which need to be purchased separately.

6540 22	Flip-up 8M To Be Equipped Version	32181	1
6540 23	Flip-up 12M To Be Equipped Version	34437	1

Incara™ Top Access (Empty)

Easy storage for an office module, Desktop Power Center, Legrand UI with Surface Box DLP with accessories or equivalent product that can accommodate chargers and wires.

Resistance to impacts: IK 07
 Operating temperature: from 5°C to +35°C

For Flush Mounting In Furniture, Compatible Table Thickness 10 To 40

6548 70	Top Access 295MM Wide Aluminium	11033	1
6548 71	Top Access 295MM Wide White	12851	1
6548 72	Top Access 295MM Wide Black	12332	1
6548 73	Top Access 395MM Wide Aluminium	14667	1
6548 74	Top Access 395MM Wide White	16420	1
6548 75	Top Access 395MM Wide Black	15706	1

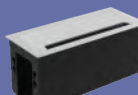

6548 70

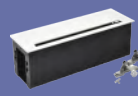

6548 73

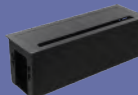

6548 75

Incara™ Pop Up (Empty)

Cat.Nos	Description	MRP* ₹ / Unit	Pack
---------	-------------	------------------	------

Resistance to Impact: IK 07
 IP 44 for 6 548 12 & IP 20 for the others
 Operating temperature: from 5°C to +35°C
 Conform to standard BS 5733
 Compatible with Arteor accessories, which need to be purchased separately.
 Switch d IS 3854 : 1997
 Sockets IS 1293: 2019
 USB IEC 60950 1
 Switch lasts 100000 & Socket for 10000 plug ins
 Fire resistant up to 850°C for 30 seconds.

For Flush Mounting In Furniture, Compatible Desktop Thickness 15 to 40.

6548 45	Pop-up 3M Brushed Aluminium	4568	1
6548 46	Pop-up 3M White	3714	1
6548 47	Pop-up 3M Black	3714	1
6548 48	Pop-up 3M Aluminium	3714	1
6548 00	Pop-up 4M Brushed Aluminium	5740	1
6548 01	Pop-up 4M White	5219	1
6548 02	Pop-up 4M Black	5219	1
6548 03	Pop-up 4M Aluminium	5219	1
6548 12	IP 44 Pop-up 4M Brushed Aluminium	8944	1
6548 08	Pop-up 8M Brushed Aluminium	11673	1
6548 09	Pop-up 8M White	10613	1
6548 10	Pop-up 8M Black	10613	1
6548 11	Pop-up 8M Aluminium	10613	1
6548 04	Pop-up 2x4M Brushed Al	12257	1
6548 05	Pop-up 2x4M Wh	11143	1
6548 06	Pop-up 2x4M Black	11143	1
6548 07	Pop-up 2x4M Al	11143	1



6548 46



6548 48



6548 00



6548 01



6548 03



6548 10



6548 04

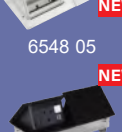

6548 05

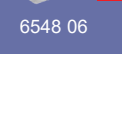

6548 06

* MRP - Maximum Retail Price Inclusive of all taxes including GST.
 Red Cat.Nos - new products

Bold Cat.Nos are products normally available with Legrand (India) Stockists.
 Cat.Nos that are not bold - delivery within 4 - 8 weeks from the date of order.
 Bold packing quantity is our mandatory packing. Orders to be placed by Legrand (India) Stockist in multiples of the same.

NEW!

Desktop Power Center

Practical Power for Modern Workspaces



Desktop Power Center (DPC) brings power and connectivity right to your fingertips. Designed for modern workspaces, it delivers seamless access to power, charging, AV, and data—while keeping desks clean, organized, and clutter-free. Fully customizable with power sockets, USB chargers, and connectivity modules, DPC adapts effortlessly to your workspace needs with style and efficiency

Features

- Modular 6M and 8M configurations with 3-pin 6A sockets and optional USB charging
- Flexible mounting options for on-desk, under-desk, or wall installation
- Child-safe IP20 sockets tested for up to 10,000 plug cycles
- IS-certified switch socket design with maximum load capacity up to 1440 W

Benefits

- Provides convenient power access directly at the workspace
- Keeps desks organised by reducing cable clutter
- Enhances user safety with child-protected outlets
- Simplifies installation with versatile mounting options



Scan to know more about the product.



Desktop Power Center

Cat.Nos	Description	MRP* ₹ / Unit	Pack
---------	-------------	------------------	------

Switch IS 3854 : 1997
Sockets IS 1293: 2019
USB IEC 60950 1
Switch lasts 100000 & Socket for 10000 plug ins
Fire resistant up to 850°C for 30 seconds.
Input : 100 240V 50 60Hz/250 mA
Output 5V 1500mA
Power rating 1440W Max
3 PIN Socket 6A 230V IP 20 Rated

Desktop Power Center supplied With L Bracket Kit

1.5 meter cord and a 3 pin plug for easy connection to power



6550 20



6550 22



6550 24



6550 21



6550 23



6550 25



6550 27

6550 20	6M DPC SKT White	1348	1
6550 22	8M DPC SKT White	1753	1
6550 24	6M DPC SKT ChicGrey	1660	1
6550 26	8M DPC SKT ChicGrey	2092	1

Desktop Power Center with USB Type A

6550 21	6M DPC SKT USB A White	2159	1
6550 23	8M DPC SKT USB A White	2966	1
6550 25	6M DPC SKT USB A ChicGrey	2495	1
6550 27	8M DPC SKT USB A ChicGrey	3412	1

Desktop Power Center with USB Type A + C Ports

6550 21AC	6M DPC SKT USB A+C White	3647	1
6550 23AC	8M DPC SKT USB A+C White	3861	1
6550 25AC	6M DPC SKT USB A+C ChicGrey	3740	1
6550 27AC	8M DPC SKT USB A+C ChicGrey	3981	1



6550 21AC



6550 23AC



6550 25AC



6550 27AC

Desktop Power Center

Cat.Nos	Description	MRP* ₹ / Unit	Pack
---------	-------------	------------------	------

Desktop Power Center (Empty)

To be equipped version of the DPC comes without the cord, installation kit, and accessories. It is compatible with Lyncus accessories, which need to be purchased separately.



6550 30



6550 31



6550 32



6550 33

6550 30	6M DPC (To Be Equipped) White	673	1
6550 31	6M DPC (To Be Equipped) ChicGrey	774	1
6550 32	8M DPC (To Be Equipped) White	878	1
6550 33	8M DPC (To Be Equipped) ChicGrey	1009	1

Desktop Power Center DPC Accessories

The accessories come with three installation kits, each containing a different bracket: the Angle L Bracket, Flat I Bracket, and Wall Mount T Bracket. The L Bracket is included with the product, while the I Bracket and T Bracket are available for purchase separately.



026988W



6550 36



6550 37



6550 38

0269 88W	Cord with 3 Pin (BIS) Wh 1.5Mtr	■	1
0269 88B	Cord with 3 Pin (BIS) Black 1.5Mtr	■	1
6550 36	DPC Angle L-Bracket		1
6550 37	DPC Flat I-Bracket		1
6550 38	DPC Wall T-Bracket		1

* MRP - Maximum Retail Price Inclusive of all taxes including GST.
■ Price available on request.

Bold Cat.Nos are products normally available with Legrand (India) Stockists. Cat.Nos that are not bold - delivery within 4 - 8 weeks from the date of order. Bold packing quantity is our mandatory packing. Orders to be placed by Legrand (India) Stockist in multiples of the same.

NEW!

DISQ 60 and DISQ 80

Compact Desk Power for Modern Workspaces



DISQ 60 & DISQ 80 bring smart, desk-integrated power, USB, and data right where you need it. Built for modern workspaces, they blend seamlessly into desks and meeting tables—delivering instant connectivity while keeping surfaces sleek, clean, and clutter-free.

Features

- Circular desk-mounted design for seamless integration into desks and meeting tables
- Integrated power and USB charging for laptops and everyday office devices
- Power sockets compliant with IS 1293 and USB compliant with IS 13252 standards
- Durable construction with IK07 impact resistance for reliable daily use

Benefits

- Provides convenient power and charging access directly at the workspace
- Maintains clean desk aesthetics with minimal visual footprint
- Reduces cable clutter and dependence on external chargers or power strips
- Supports efficient and organised workspaces in offices and meeting rooms



Everything you need.
Right where you work



Disq 60

INCARA DISQ 60 delivers sleek, discreet access to power or USB charging with quick, hassle-free installation.

- Ultimate flexibility – mount horizontally or vertically on any surface, from desks to sofas and lockers, with a patented system that fits even ultra-thin panels (1 mm).



Disq 80

INCARA DISQ 80 combines power, data, and charging in one compact solution for modern, mobile users.

- Ideal for individual workstations, delivering seamless and efficient connectivity.
- Smart retrofit design – easily replaces existing cable outlets (80 mm Ø cut-out).
- Flexible configurations with 6 UTP sockets or cable outlets for quick, hassle-free access.

* MRP - Maximum Retail Price Inclusive of all taxes including GST.
Red Cat.Nos - new products

NEW! Disq 60 and Disq 80

Cat.Nos	Description	MRP* ₹ / Unit	Pack
---------	-------------	------------------	------

Supply voltage: 250V~
Frequency: 50/60 Hz
Sockets complies with IS 1293
USB complies with IS 13252
Resistance to impact: IK 07
Operating temperature: from -5°C to +35°C
Storage temperature: from -10°C to +70°C



6540 32



6540 29



6540 30



6540 31



6540 33



6540 36



6540 37



6540 39



6540 40

6540 32	DISQ 60 1 6A SKT WH	3530	1
6540 29	DISQ 60 1 6A SKT BL	3530	1
6540 30	DISQ 60 1 USB A+C WH	6270	1
6540 31	DISQ 60 1 USB A+C BL	6270	1
6540 33	DISQ 80 1 6A SKT USB C 15W CABLE OUTLET WH	6240	1
6540 36	DISQ 80 1 6A SKT USB C 15W CABLE OUTLET BL	6240	1
6540 34	DISQ 80 1 6A SKT USB A+C 15W RJ45 CAT6 WH	6550	1
6540 37	DISQ 80 1 6A SKT USB A+C 15W RJ45 CAT6 BL	6550	1
6540 39	DISQ 80 1 6A SKT USB C 15W CABLE OUTLET BL-METAL	6730	1
6540 40	DISQ 80 1 6A SKT USB C 15W RJ45 CAT6 BL-METAL	7070	1

Bold Cat.Nos are products normally available with Legrand (India) Stockists. Cat.Nos that are not bold - delivery within 4 - 8 weeks from the date of order. Bold packing quantity is our mandatory packing. Orders to be placed by Legrand (India) Stockist in multiples of the same.

POP-UP BOXES For Floor

Seamless Floor Design, Superior Protection



Pop-up Boxes for Floor provide discreet floor-mounted access to power, data, and AV connections in modern workspaces. With a slim profile, soft-opening mechanism, and durable construction, they integrate smoothly into floor systems while ensuring reliable connectivity for offices and collaborative environments.

Features

- Extra-slim floor box design with corrosion-resistant, halogen-free construction
- Soft-opening cover with damper and push-slide locking mechanism
- Modular configuration for power, audio, video, and data using Arteor modules
- Robust protection: IP40 rating and IK07 impact resistance for high-traffic areas

Benefits

- Maintains clean floor aesthetics with discreet connectivity access
- Reduces cable clutter by providing power and data at floor level
- Ensures durable performance in high-use commercial environments
- Enhances user convenience with smooth and secure opening operation



Scan to know more about
the product.



Pop Up Box

Cat.Nos	Description	MRP* ₹ / Unit	Pack
---------	-------------	------------------	------

Pop Up Flush Mounting Boxes For Floor To Be Equipped

Installation accessories should be considered additionally along with the pop up box.

For installation, use flush mounting boxes for concrete floors or kits for raised access floors.

To be equipped with Arteor accessories.

3 modules

0540 10	Pop-up 3M Aluminium	3795	1
0540 15	Pop-up 3M Brass	4963	1
0540 20	Pop-up 3M Stainless Steel	5015	1



0540 15



0540 20

4 Modules

0540 11	Pop-up 4M Aluminium	5094	1
0540 16	Pop-up 4M Brass	5872	1
0540 21	Pop-up 4M Stainless Steel	6357	1
0540 26	Pop-up 4M Matt Black	5650	1
0540 31	Pop-up 4M Glossy White	5783	1



0540 16



0540 21



0540 26



0540 31

6 (2 x 3) Modules

0540 12	Pop-up 6M Aluminium	8516	1
0540 17	Pop-up 6M Brass	10649	1
0540 22	Pop-up 6M Stainless Steel	11042	1



0540 12

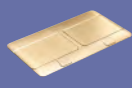

0540 17



0540 22



0540 18



0540 23



0540 28



0540 33



0540 06



0540 00

Pop Up Box

Cat.Nos	Description	MRP* ₹ / Unit	Pack
---------	-------------	------------------	------

8 (2 x 4) Modules

0540 13	Pop-up 8M Aluminium	10546	1
0540 18	Pop-up 8M Brass	12779	1
0540 23	Pop-up 8M Stainless Steel	13595	1
0540 28	Pop-up 8M Matt Black	12141	1
0540 33	Pop-up 8M Glossy White	12211	1

Installation Kits For Raised Access Floors

Include an empty receptacle and fixing brackets for raised access floor tiles Compatible with:

- Cat. 6 data cabling
- Audio/video cabling

0540 05	Installation Kit 3M Pop-up	1576	1
0540 06	Installation Kit 4M Pop-up	1892	1
0540 07	Installation Kit 6M Pop-up	2623	1
0540 08	Installation Kit 8M Pop-up	3238	1

For Installation Of Pop-Up Floor Boxes In Concrete Floors

Equipped with knockouts for \varnothing 20 and \varnothing 25 mm conduits

Metal Flush-Mounting Boxes

0540 00	Back Box Concrete 3M Pop-up	408	1
0540 01	Back Box Concrete 4M Pop-up	540	1
0540 02	Back Box Concrete 6M Pop-up	863	1
0540 03	Back Box Concrete 8M Pop-up	1085	1

* MRP - Maximum Retail Price Inclusive of all taxes including GST.

Bold Cat.Nos are products normally available with Legrand (India) Stockists. Cat.Nos that are not bold - delivery within 4 - 8 weeks from the date of order. Bold packing quantity is our mandatory packing. Orders to be placed by Legrand (India) Stockist in multiples of the same.

Floor Boxes

A Perfect Fit in any Commercial Space



Designed for project managers, consultants, architects, and end users alike, this modern solution is crafted for evolving spaces and dynamic environments. It blends seamlessly into contemporary architecture, enhancing the overall look and feel of any interior.

Features

- Modular 45 mm system for maximum flexibility
- Multiple sizes & capacities (8 to 24 modules)
- Horizontal & vertical configurations for smart space use
- Premium finish options (plastic / stainless steel, flush or frame)

Benefits

- Faster installation, lower labour cost (tool-free snap-in system)
- Seamless integration with any floor finish (clean, modern look)
- Fully customizable for power, data & multimedia needs
- Reliable & compliant for long-term performance and safety

Scan to know more about the product.



Frame & lid version
Plastic LID



Frame & lid version
Stainless steel finish



Flush lid version
Stainless steel finish

Floor Solution

Cat.Nos	Description	MRP* ₹ / Unit	Pack
---------	-------------	------------------	------

Selection Chart

Back Box	+	Lid & Trim	+	Support Plate
Floor Box for Raised Floor				
6896 38	+	689631	+	689662/ 689617/ 689678
Floor Box for screed Floor (3 Compartment)				
6896 34	+	689631	+	689662/ 689617/ 689678
Floor Box for screed Floor (4 Compartment)				
6896 45	+	689641	+	89662/ 689617/ 689678
Floor box for Tiles/Marble				
0896 04	+	689652/689655/689656+	+	689662/ 689617/ 689678
50 Reduced Height Floor Box				
0880 73	+	088070	+	689662/ 689617/ 689678

Regular Floor Boxes Range

Floor Boxes for Raised & Screed Floor (3-CMP)

6896 38	RF Backbox for 3-CPM (For Carpet)	6141	1
6896 34	SF Backbox For 3-CPM (For Carpet)	9612	1
6896 31	265X265 Lid & Trim Carpet 8MM 3-CPM	4684	5

Regular Floor Boxes for Screed Floor (4-CMP)

6896 45	Backbox for 4-CPM	10541	1
6896 41	Lid & Trim 4-CPM	5067	1

Stainless Steel Insert for Lid

For a metal finish on lid
To be used instead of fitting carpet onto the Lid

6896 92	SS Insert For Lid	5700	1
---------	-------------------	------	---

Floor Solution

Cat.Nos	Description	MRP* ₹ / Unit	Pack
---------	-------------	------------------	------

Floor Boxes for Tile / Marble

0896 04	Backbox (For Tile)	7917	1
6896 52	Floor Box Tile 15 To 22MM	39710	1
6896 55	Lid/Trim Grey Painted Headband Tile 8 To 15MM	10891	5
6896 56	Lid/Trim SS Headband Tile 8 To 15MM	12520	5

Reduced Height Vertical Floor Box - 50mm

0880 73	Back Box (Use With 088070)	11683	1
0880 70	Lid & Trim 50 To 70 MM	11537	1
0880 72	SS Insert PL For 50MM FB	7351	5

Support Plates for Regular Floor Boxes

77 mm with plate

689662L	Blank Plate	497	12
6896 17	Support Plate Myrius 8M	532	1
6896 78	Support Plate Waved	1538	5

NEW! Heavy Duty Floor Boxes IP40

0880 80	Boite encastrable réglable 55-125	19284	1
0880 86	4 screws for height extension feet	3750	1
0880 88	Foam block for height extension	8200	1
0896 82	Heavy load support 15KN	65750	1
0896 85	Access trap for junction	54752	1
0896 86	Floor box with direct central exit	116549	1
0896 87	Cable exit accessory - IP52	62273	1

Bold Cat.Nos are products normally available with Legrand (India) Stockists. Cat.Nos that are not bold - delivery within 4 - 8 weeks from the date of order. Bold packing quantity is our mandatory packing. Orders to be placed by Legrand (India) Stockist in multiples of the same.

* MRP - Maximum Retail Price Inclusive of all taxes including GST. For regular floor boxes height adjustment is 65-90mm without accessories and 77-90mm with accessories.
Red Cat.Nos - new products



6896 38 +
6896 31



6896 34 +
6896 31

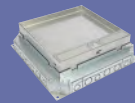

0896 04 +
6896 52

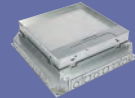

0896 04 +
6896 55

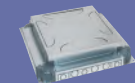

0880 73

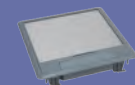

0880 70

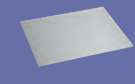

0880 72

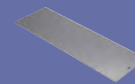

689662L



6896 17

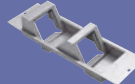

6896 78

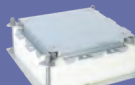

0880 80



0896 82



0896 87

Floor Solution

Cat.Nos	Description	MRP* ₹ / Unit	Pack
---------	-------------	------------------	------

NEW! New Floor Boxes

Plastic Grey Lid and Trim

0807 09	Frame & Lid Plastic Screed 12 M Hz	6150	1
0807 10	Frame & Lid Plastic Screed 18 M Hz	6680	1
0807 11	Frame & Lid Plastic Screed 24 M Hz	7970	1
0807 12	Frame & Lid Plastic Screed 8 M Vt	7760	1
0807 13	Frame & Lid Plastic Screed 12 M Vt	9540	1
0807 14	Frame & Lid Plastic Screed 16 M Vt	11340	1



NEW! Metal SS Finish Lid and Trim

0807 27	Frame & Lid Metal Screed 12 M Hz	26520	1
0807 28	Frame & Lid Metal Screed 18 M Hz	27430	1
0807 29	Frame & Lid Metal Screed 24 M Hz	28930	1
0807 30	Frame & Lid Metal Screed 8 M Vt	28180	1
0807 31	Frame & Lid Metal Screed 12 M Vt	30400	1
0807 32	Frame & Lid Metal Screed 16 M Vt	32410	1



NEW! Flush Metal SS Finish Lid & Trim

0807 45	Flush Concrete Floor 12 Modules Hz	29450	1
0807 46	Flush Concrete Floor 18 Modules Hz	35420	1
0807 47	Flush Concrete Floor 24 Modules Hz	36560	1
0807 48	Flush Concrete Floor 8 Modules Vt	31000	1
0807 49	Flush Concrete Floor 12 Modules Vt	38390	1



Floor Solution

Cat.Nos	Description	MRP* ₹ / Unit	Pack
---------	-------------	------------------	------

0807 50	Flush Concrete Floor 16 Modules Vt	39900	1
---------	------------------------------------	-------	---



Universal Adjustable Backbox

0880 80	Universal Back Box 55-125MM	19284	1
---------	-----------------------------	-------	---

Mounting Adaptors For Screed Floor

0880 81	Adaptation Plate for 8/12M	4173	1
0880 82	Adaptation Plate for 12/18M	4512	1
0880 83	Adaptation Plate for 16/24M	4830	1



Auto-Adjusting Backbox

0880 90	Back Box 8/12M 65-90MM	5772	1
0880 91	Back Box 12/18M 65-90MM	6998	1
0880 92	Back Box 16/24M 65-90MM	8213	1



NEW! Reno Back Box

0881 90	Reno Back Box for Std Fb 8/12m	4650	1
0881 91	Reno Backbox for Std Fb 12/18m	5160	1
0881 92	Reno Backbox for Std Fb 16/24m	5070	1



Finish Plates

0880 15	SS Plate Grey Lid 8/12M	5667	1
0880 16	SS Plate Grey Lid 12/18M	5802	1
0880 17	SS Plate Grey Lid 16/24M	7872	1

* MRP - Maximum Retail Price Inclusive of all taxes including GST.
Red Cat.Nos - new products

Bold Cat.Nos are products normally available with Legrand (India) Stockists. Cat.Nos that are not bold - delivery within 4 - 8 weeks from the date of order. Bold packing quantity is our mandatory packing. Orders to be placed by Legrand (India) Stockist in multiples of the same.

Floor Solution



Cat.Nos	Description	MRP* ₹ / Unit	Pack
0880 45	SS Plate Metal Lid 8/12M	8426	1
0880 46	SS Plate Metal Lid 12/18M	9670	1
0880 47	SS Plate Metal Lid 16/24M	10994	1

Floor Boxes 3 Module

Conform to EN 50 085 2.2 and EN 60670 23

IP 20/IK07

Compression test, 500N / 1cm² during 1 min :

Comply with norm CEI 60670 23 (2004)



0896 44	Floor Box 3M	2499	1
0896 49	Flush Mounting Box 3M	1663	1

IP66 Floor Box

IP66 Floor box complies with the IEC 60670 1 and IEC 60670 23 standards.

Resistance to loads: with the cover closed: 10000 N

Resistance to impacts: IK 09 with the cover closed

Self extinguishing : + 650° C / 30 s for parts made of insulating materials.









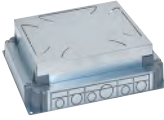

0880 61	IP66/IK09 Screwed SS Floor Box	27291	1
0880 64	IP66/IK09 Hinged CVR SS Floor Box	32052	1
0880 69	Back Box IP66 Floor, Min Screed Height 65	5237	1
0880 62	IP55 Cable Exit Accessory	30401	1
0893 07	Floor Access Unit Circular	11683	1

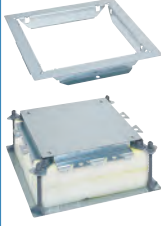
* MRP - Maximum Retail Price Inclusive of all taxes including GST.
Red Cat.Nos - new products

Bold Cat.Nos are products normally available with Legrand (India) Stockists.
Cat.Nos that are not bold - delivery within 4 - 8 weeks from the date of order.
Bold packing quantity is our mandatory packing. Orders to be placed by Legrand (India) Stockist in multiples of the same.



Frame and Lid Floor Boxes for Concrete Floor Selection Chart

FLOOR BOX TYPE	FLOOR BOX CAPACITY	FLOOR BOX CAT.NOS	BACKBOX TO SELECT ACCORDING TO CONCRETE SCREED DEPTH					FINISHING PLATES (OPTIONAL)		
										
SOCKETS IN HORIZONTAL POSITION			77 - 90⁽¹⁾⁽²⁾ mm	80 - 110⁽²⁾ mm	76 - 125⁽²⁾ mm	110 - 170 mm	150 - 250 mm			
PLASTIC FRAME AND LID 	12 (3 x 4) modules	0 807 09	0 880 90	0 881 90	0 880 80 + 0 880 81	+	0 880 88 + 0 880 86	+	0 880 88	0 880 15
	18 (3 x 6) modules	0 807 10	0 880 91	0 881 91	0 880 80 + 0 880 82					0 880 16
	24 (3 x 8) modules	0 807 11	0 880 92	0 881 92	0 880 80 + 0 880 83					0 880 17
METAL FRAME AND LID 	12 (3 x 4) modules	0 807 27	0 880 90	0 881 90	0 880 80 + 0 880 81	+	0 880 88 + 0 880 86	+	0 880 88	0 880 45
	18 (3 x 6) modules	0 807 28	0 880 91	0 881 91	0 880 80 + 0 880 82					0 880 46
	24 (3 x 8) modules	0 807 29	0 880 92	0 881 92	0 880 80 + 0 880 83					0 880 47
SOCKETS IN VERTICAL POSITION			69 - 90⁽¹⁾ mm	72 - 110 mm	68 - 125 mm	110 - 170 mm	150 - 250 mm			
PLASTIC FRAME AND LID 	8 (2 x 4) modules	0 807 12	0 880 90	0 881 90	0 880 80 + 0 880 81	+	0 880 88 + 0 880 86	+	0 880 88	0 880 15
	12 (2 x 6) modules	0 807 13	0 880 91	0 881 91	0 880 80 + 0 880 82					0 880 16
	16 (2 x 8) modules	0 807 14	0 880 92	0 881 92	0 880 80 + 0 880 83					0 880 17
METAL FRAME AND LID 	8 (2 x 4) modules	0 807 30	0 880 90	0 881 90	0 880 80 + 0 880 81	+	0 880 88 + 0 880 86	+	0 880 88	0 880 45
	12 (2 x 6) modules	0 807 31	0 880 91	0 881 91	0 880 80 + 0 880 82					0 880 46
	16 (2 x 8) modules	0 807 32	0 880 92	0 881 92	0 880 80 + 0 880 83					0 880 47















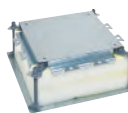

1: From 90 mm to 200 mm with the fixing kit for elevating and leveling Cat.No 0 807 55

2: Minimum dimensions when used with straight plugs

Frame and Lid Floor Boxes for Concrete Floor Selection Chart

FLOOR BOX TYPE	FLOOR BOX CAPACITY	FLOOR BOX CAT.NOS	BACKBOX TO SELECT ACCORDING TO CONCRETE SCREED DEPTH				FINISHING PLATES (OPTIONAL)
			89 - 90 ⁽¹⁾⁽²⁾ mm	88 - 122 ⁽²⁾ mm	110 - 170 mm	150 - 250 mm	
SOCKETS IN HORIZONTAL POSITION			89 - 90⁽¹⁾⁽²⁾ mm	88 - 122⁽²⁾ mm	110 - 170 mm	150 - 250 mm	
	12 (3 x 4) modules	0 807 45	0 880 90	0 880 80 + 0 880 81	+	0 880 88 + 0 880 86 + 0 881 42	0 881 45
	18 (3 x 6) modules	0 807 46	0 880 91	0 880 80 + 0 880 82			0 881 46
	24 (3 x 8) modules	0 807 47	0 880 92	0 880 80 + 0 880 83			0 881 47
SOCKETS IN VERTICAL POSITION			82 - 90⁽¹⁾ mm	81 - 122 mm	110 - 170 mm	150 - 250 mm	
	8 (2 x 4) modules	0 807 48	0 880 90	0 880 80 + 0 880 81	+	0 880 88 + 0 880 86 + 0 881 42	0 881 45
	12 (2 x 6) modules	0 807 49	0 880 91	0 880 80 + 0 880 82			0 881 46
	16 (2 x 8) modules	0 807 50	0 880 92	0 880 80 + 0 880 83			0 881 47

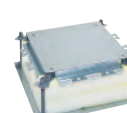
Mouting Principle

	=		OR		OR		+		OR		OR		+	
Floor box with sockets in horizontal position		Type : Standard Frame : Horizontal Lid : Plastic Grey		Type : Standard Frame : Horizontal Lid : SS Finish		Type : Flush Frame : Horizontal Lid : SS Finish		Regular Back Box		Box (Plastic) (Not compatible with Flush type Lid)		Universal adjustable Back Box		Arteor Accessories
	=		OR		OR		+		OR		OR		+	
Floor box with sockets in vertical position		Type : Standard Frame : Vertical Lid : Plastic Grey		Type : Standard Frame : Vertical Lid : SS Finish		Type : Flush Frame : Vertical Lid : SS Finish		Regular Back Box		Box (Plastic) (Not compatible with Flush type Lid)		Universal adjustable Back Box		Arteor Accessories

DLP™ Mini-Trunking

Flexible and Aesthetic Cable Management Solution



DLP™ Mini-Trunking offers a practical solution for organized cable routing, protection, and distribution in electrical installations. Its modular design enables neat cable management while supporting easy integration of wiring accessories across residential, commercial, and service environments.

Features

- Flexible system to adapt to every kind of wall-building configuration
- A new aesthetics, colour : RAL 9003 brilliant white
- A RoHS product = lead free product
- High resistance against UV to limit the change of the colour during the life of the installation
- Non-Flame Propagating; material : high impact self-extinguishing

Benefits

- Simplifies installation with clip-on assembly and easy maintenance access
- Ensures organized cable routing with safe separation of circuits
- Provides durable protection with IP40 enclosure and IK07 impact resistance
- Delivers a clean aesthetic finish suitable for visible installations

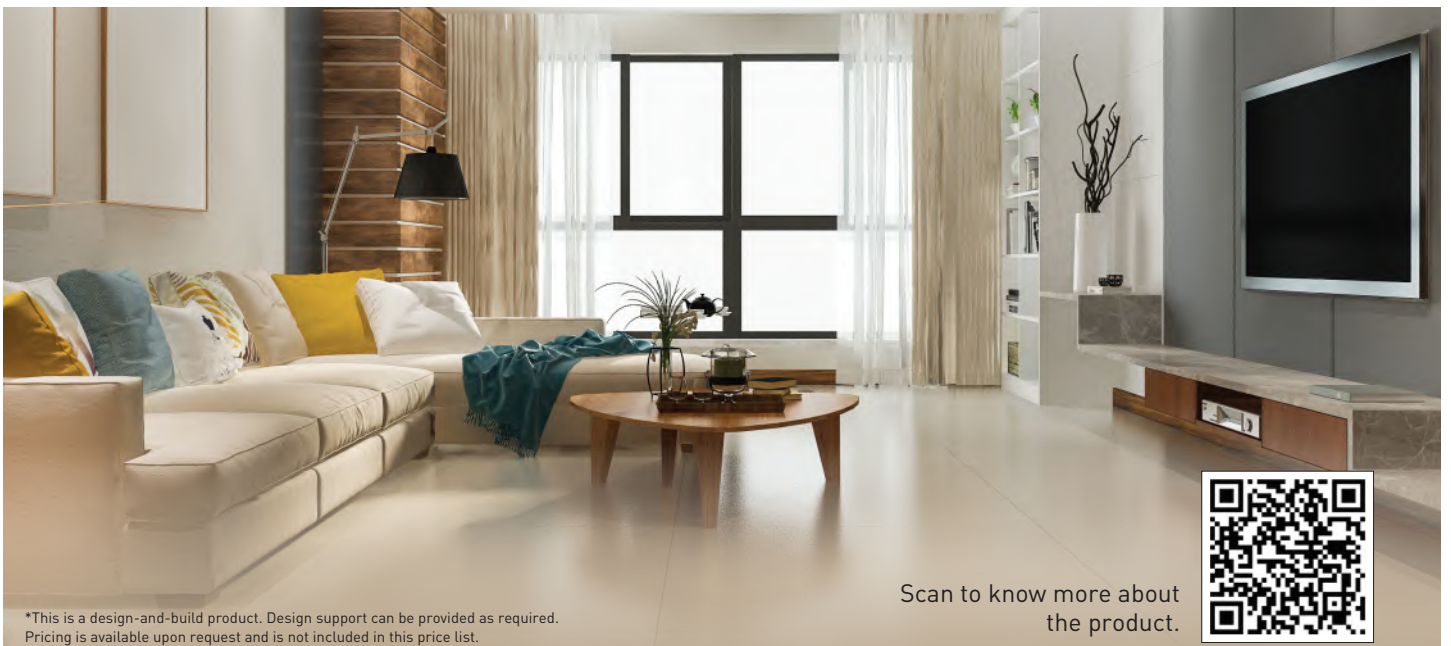

*This is a design-and-build product. Design support can be provided as required. Pricing is available upon request and is not included in this price list.

Scan to know more about
the product.



Cat.Nos	Description	MRP* ₹ / Unit	Pack
DLP Mini Trunking			
Mini-trunking system			
Standard length 2 meters; Price per meter			
Mini-trunking - 32 x 12.5 mm			
0300 15	Mini TRK 32X125 White	202	80 ⁽¹⁾
Finishing Accessories			
0312 03	End Cap For 32X125	112	20/400
0302 51	Int/Ext Angle For 32X125	154	10/100
0302 53	Flat Angle For 32X125	166	10/100
0302 54	Flat Junction For 32X125	217	10/200
0336 03	White 32X10/125 Cover Gasket	218	20
Mini-Trunking - 32 x 16 mm			
0308 04	Mini TRK 32X16 White 210	269	60 ⁽¹⁾
Finishing Accessories			
0312 07	End Cap For 32X16	163	10
0333 25	Int/Ext Angle For 32X16	217	10
Mini-Trunking - 32 x 20 mm			
0300 17	Mini TRK 32X20 White 210	352	50 ⁽¹⁾
Finishing Accessories			
0312 09	End Cap For 32X20	234	10
0302 71	Int/Ext Angle For 32X20	217	10
0302 73	Flat Angle For 32X20	272	10
0302 74	Flat Junction For 32X20	459	10
0336 04	White 32X16/20 Cover Gasket	315	20

DLP Mini Trunking Systems

For Cable Distribution

Selection Chart for DLP Mini Trunking

	Length	Finishing Accessories				Junction Elements
WHITE	2 m	End cap	Internal angle	External angle	Flat angle	Flat junction
32 x 12.5	0300 15	0312 03	0302 51	0302 51	0302 53	0302 54
32 x 16	0308 04	0312 07	0333 25	0333 25	0333 27	0333 30
32 x 20	0300 17	0312 09	0302 71	0302 71	0302 73	0302 74

Bold Cat.Nos are products normally available with Legrand (India) Stockists. Cat.Nos that are not bold - delivery within 4 - 8 weeks from the date of order. Bold packing quantity is our mandatory packing. Orders to be placed by Legrand (India) Stockist in multiples of the same.

DLP-S

UNIVERSAL TRUNKING

FOR THE ESSENTIALS

- Traditional installation method with modular or with universal supports
- Compatible with all types of 45 mm mechanisms (like Arteor)

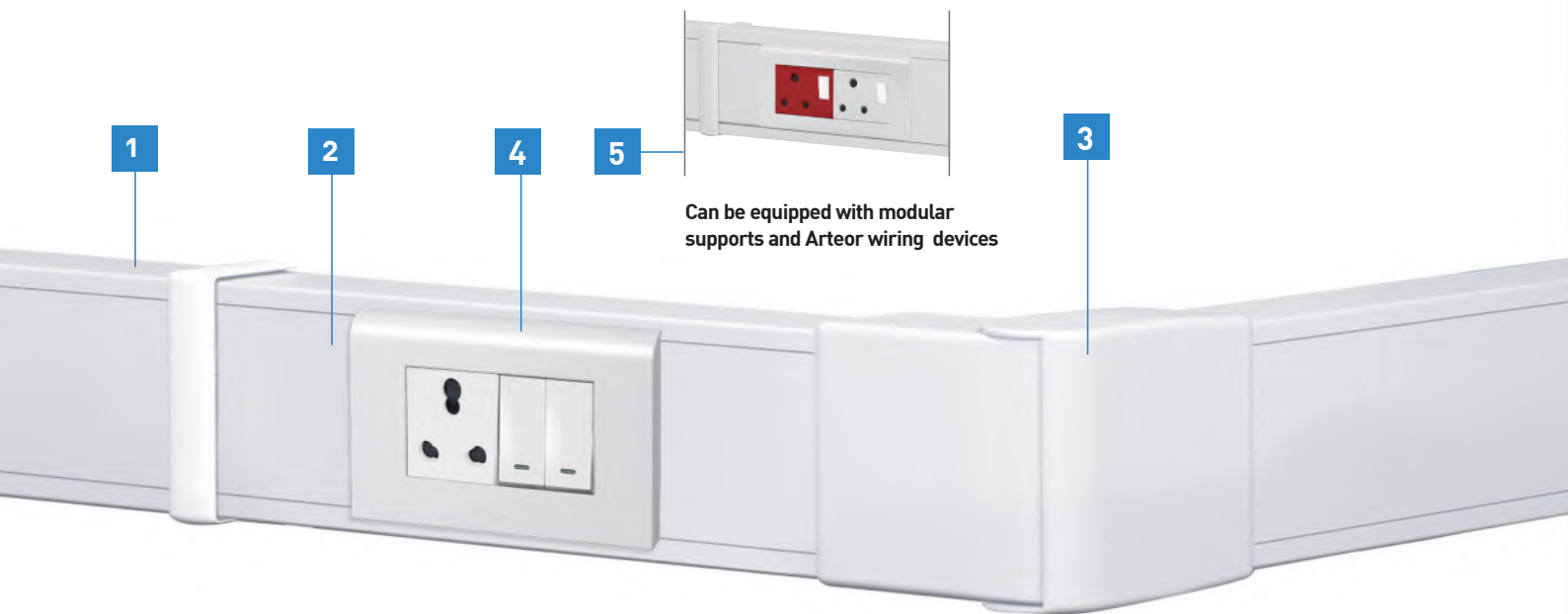

1 Rigid profiles with perforations



2 Self-guiding cover

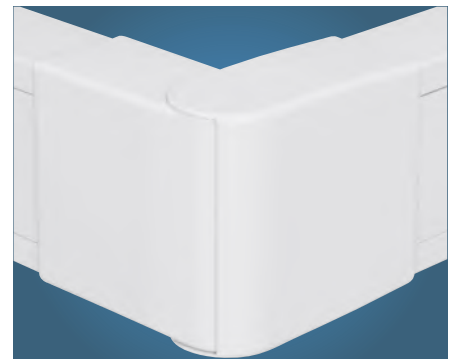

3 Ready to install accessories



Scan to know more about the product.



4 Myrius single module switch with brackets

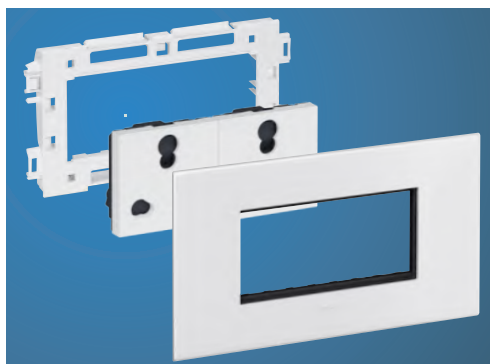

5 Arteor sockets and modular support

DLP-S Universal Trunking

Cat.Nos	Description	MRP* ₹ / Unit	Pack
---------	-------------	------------------	------

Standard length 2 meters; Price per meter Trunking

Body with cover

6380 38	DLP-S TRK+CVR 100X502M	1435	12 ⁽¹⁾
---------	------------------------	------	-------------------

Partition

6380 08	DLP-S Separation Partition	336	32 ⁽¹⁾
---------	----------------------------	-----	-------------------

Joints

6380 36	DLP-S Body Joint 100X50	160	10
6380 01	DLP-S Cover Joint 75	237	50

Angles and end caps

Variable angles

6380 31	DLP-S Variable Int Angle 100X50	700	10
6380 32	DLP-S Variable Ext Angle 100X50	700	10

Fixed angles

6380 11	DLP-S Int Angle For 100X50	362	20
6380 12	DLP-S Ext Angle For 100X50	372	20

Flat angle

6380 13	DLP-S Flat Angle For 100X50	803	16
---------	-----------------------------	-----	----

End cap

6380 35	DLP-S End Cap 100X50	204	20
---------	----------------------	-----	----

Bracket

6380 05	DLP-S Bracket CV80	169	10/100
---------	--------------------	-----	--------

Junction

6380 34	DLP-S Tee 100X50	1763	5
---------	------------------	------	---

Supports for Mounting Wiring Accessories

Arteor™ & Myrius supports

Clip-on supports which can be fitted side by side
Supplied with finishing plate

6380 71	DLP-S 2 Modules Frame	440	10
6380 72	DLP-S 4 Modules Frame	640	5
6380 73	DLP-S 6 Modules Frame	759	5

* MRP - Maximum Retail Price Inclusive of all taxes including GST.

Bold Cat.Nos are products normally available with Legrand (India) Stockists. Cat.Nos that are not bold - delivery within 4 - 8 weeks from the date of order. Bold packing quantity is our mandatory packing. Orders to be placed by Legrand (India) Stockist in multiples of the same.

P17 Tempra Pro IP 44 - LV 16 and 32 A - Sockets and Plugs

Cat.Nos	Description	MRP* ₹ / Unit	Pack
---------	-------------	------------------	------

Surface Mounting Sockets

5551 54	200/250 VA, 16 A 2P+E	971	10
5551 58	380/415 VA, 16 A 3P+E	1197	10
5551 59	380/415 VA, 16 A 3P+N+E	1268	10
5552 54	200/250 VA, 32 A 2P+E	1213	5
5552 58	380/415 VA, 32 A 3P+E	1518	10
5552 59	380/415 VA, 32 A 3P+N+E	1610	10

Panel Mounting Sockets Inclined Outlet

5551 84	200/250 VA, 16 A 2P+E	602	10
5551 88	380/415 VA, 16 A 3P+E	885	10
5551 89	380/415 VA, 16 A 3P+N+E	933	10
5552 84	200/250 VA, 32 A 2P+E	926	10
5552 88	380/415 VA, 32 A 3P+E	1170	10
5552 89	380/415 VA, 32 A 3P+N+E	1240	10

Mobile Sockets

5551 04	200/250 VA, 16 A 2P+E	784	10
5551 08	380/415 VA, 16 A 3P+E	873	10
5551 09	380/415 VA, 16 A 3P+N+E	926	10
5552 14	200/250 VA, 32 A 2P+E	1040	10
5552 18	380/415 VA, 32 A 3P+E	1249	10
5552 19	380/415 VA, 32 A 3P+N+E	1320	10

Straight Plugs

5551 24	200/250 VA, 16 A 2P+E	556	10
5551 28	380/415 VA, 16 A 3P+E	682	10
5551 29	380/415 VA, 16 A 3P+N+E	716	10
5552 34	200/250 VA, 32 A 2P+E	837	10
5552 38	380/415 VA, 32 A 3P+E	955	10
5552 39	380/415 VA, 32 A 3P+N+E	1012	10

P17 Tempra - Domestic Pin Configuration 16 A - 250 VA

Flush-Mounting Boxes

0577 21	For 2 panel mounting sockets With single fixing centres 70 x 70 mm - 16 A	5499	3
0577 22	For 1 panel mounting socket With single fixing centres 70 x 70 mm - 16 or 32 A (32 A to be fixed horizontally)	3300	3

P17 Tempra Pro IP 66/67 LV 16 and 32 A

Cat.Nos	Polarity	MRP* ₹ / Unit	Pack
---------	----------	------------------	------

Surface Mounting Sockets

5553 54	200/250 V~, 16 A 2P+E	1623	5
5553 58	380/415 V~, 16 A 3P+E	1806	5
5553 59	380/415 V~, 16 A 3P+N+E	1965	5
5554 54	200/250 V~, 32 A 2P+E	1924	5
5554 55	200/250 V~, 32 A 3P+E	3324	5
5554 59	380/415 V~, 32 A 3P+N+E	3602	5

Panel Mounting Sockets

5553 84	200/250 V~, 16 A 2P+E	1188	5
5553 88	380/415 V~, 16 A 3P+E	1263	5
5553 89	380/415 V~, 16 A 3P+N+E	1343	5
5554 84	200/250 V~, 32 A 2P+E	1507	5
5554 88	380/415 V~, 32 A 3P+E	1726	5
5554 89	380/415 V~, 32 A 3P+N+E	1833	5

Mobile Sockets

5553 04	200/250 V~, 16 A 2P+E	1452	5
5553 08	380/415 V~, 16 A 3P+E	1806	5
5553 09	380/415 V~, 16 A 3P+N+E	1917	5
5554 14	200/250 V~, 32 A 2P+E	1995	5
5554 18	380/415 V~, 32 A 3P+E	2132	5
5554 19	380/415 V~, 32 A 3P+N+E	2264	5

Straight Plugs

5553 24	200/250 V~, 16 A 2P+E	1263	5
5553 28	380/415 V~, 16 A 3P+E	1386	5
5553 29	380/415 V~, 16 A 3P+N+E	1473	5
5554 34	200/250 V~, 32 A 2P+E	1710	5
5554 38	380/415 V~, 32 A 3P+E	1797	5
5554 39	380/415 V~, 32 A 3P+N+E	1906	5

Metra Plugs And Sockets

Plugs

Ivory

6500 22	240 V, 10 A, 2P+E	260	1/5/100
6500 28	240 V, 20 A, 2P+E	273	1/5/100

Grey

6500 02	240 V, 10 A, 2P+E	260	1/5/100
6500 08	240 V, 20 A, 2P+E	273	1/5/100
6500 10	440 V, 20 A, 3P+E	364	1/5/100
6500 16	440 V, 32 A, 3P+E	685	1/5/100

Sockets

6500 03	240 V, 10 A, 2P+E With blue cap	264	1/5/100
6500 23	240 V, 10 A, 2P+E With ivory cap	264	1/5/100

Sockets

6500 09	240 V, 20 A, 2P+E With blue cap	303	1/5/100
6500 29	240 V, 20 A, 2P+E With ivory cap	303	1/5/100
6500 11	440 V, 20 A, 3P+E With red cap	407	1/5/100
6500 17	440 V, 32 A, 3P+E With red cap	685	1/5/100

* MRP - Maximum Retail Price Inclusive of all taxes including GST.

Bold Cat.Nos are products normally available with Legrand (India) Stockists. Cat.Nos that are not bold - delivery within 4 - 8 weeks from the date of order. Bold packing quantity is our mandatory packing. Orders to be placed by Legrand (India) Stockist in multiples of the same.

Warranty policy

Legrand warrants to the original purchaser that the Products (excluding any third party products purchased through Legrand, for which no warranties are made) will be free from defects in material and workmanship, under normal use and regular service, and preventative maintenance for a period of 18 months from the date of shipment or 12 months from the date of installation whichever is earlier. Should any failure to conform with this warranty be found during the Warranty Period, you must notify Legrand of your claim within thirty (30) days of discovery, and within the Warranty Period. Your failure to give notice of claims of breach of warranty within the Warranty Period shall be deemed an absolute and unconditional waiver of claims for such defects. Legrand will have no responsibility to honour claims received after the date the applicable Warranty Period expires. The invoice / bill in original must be produced without which warranty claim shall not be entertained.

This warranty does not cover the following:

- Defect caused due to misuse, alteration, faulty installation, faulty electrical systems, negligent maintenance or misapplication of the product.
- Failure of product or components due to any act of nature; lightning strike, floods, hurricanes, tornadoes, etc. beyond the control of human being.
- Legrand does not warrant any third party products or associated hardware or their performance or suitability for use and application. Such items are provided "as-is".

Extended warranty policy is applicable for following products,

1. DX³ & RX³ MCB – 5 years if mounted inside Legrand DB
2. Arteor™ Advance, Arteor™, Myrius™, Mylinc™, Lyncus™, Allzy™, switches (without neon lamp) & Power sockets – 10 years
3. Arteor™ Advance, Arteor™, Myrius™, Mylinc™, Lyncus™, Allzy™, other products – 2 years

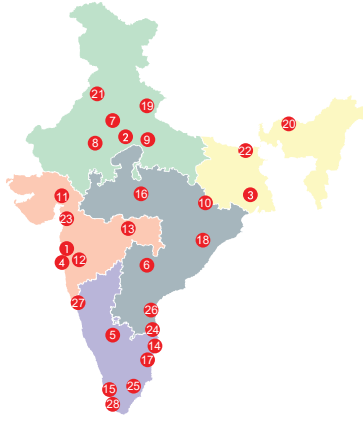

Head offices

- 61 & 62, 6th Floor,
Kalpataru Square, Kondivita Road,
Off Andheri-Kurla Road, Andheri (E),
MUMBAI – 400 059.
Tel.: (022) 3041 6200
Fax : (022) 3041 6201
Website : www.legrand.co.in

Regional sales offices

- B-225, 4th Floor, Okhla Industrial Area, Phase -1,
NEW DELHI – 110020.
Tel.: (011) 3990 2200 **INNOVAL**
- Ecocenter Ambuja Neotia,
Block - EM-04, 12th Floor,
Unit - 1203, Sector - V, Salt Lake,
KOLKATA – 700 091.
Tel.: (033) 4021 3535 / 3536 **INNOVAL**
- C/203, Corporate Avenue, Atul Projects,
Near Mirador Hotel, Chakala,
Andheri - Ghatkopar Link Road,
Andheri - (E), **MUMBAI** – 400 099.
Tel.: (022) 6230 1000 **INNOVAL**
- Ferozes Manor, 1st Floor, No. 58,
Bowring Hospital Road,
BANGALORE – 560 001.
Tel.: (080) 80682 20000 **INNOVAL**
- Prestige Phoenix, 1st Floor,
Survey number 199,
Door No. 6-3-1219/J/101 & 102,
Begumpet, **HYDERABAD**,
Telangana - 500 016
Tel.: (040) 4567 1717/2341 4398/234 14367 **INNOVAL**

Branch offices

- Bestech Business Tower
Unit no. 203, 2nd floor
Tower -B, Sector -66,
MOHALI- 160 062
Tel.: (0172) 5019 008/ 4635 145 **INNOVAL**
- 128, Mohan Nagar besides
Ridhi Siddhi Flyover, **JAIPUR** - 302019
Tel.: 0141-220 8665 **INNOVAL**
- 209-A, 2nd Floor, Cyber Heights,
Opp. Indira Gandhi Pratishthan,
Vibhuti Khand, Gomti Nagar,
LUCKNOW – 226 010.
Tel.: (0522) 457 5427 **INNOVAL**
- 202 & 203, Sunrise, Forum 100,
Burdwan Compound, Lalpur,
RANCHI - 834 001.
Tel.: (651) 660 5400
- A 101-102, Mondeal Heights,
Besides Novotel Hotel, Sarkhej
Gandhinagar Highway (S G Highway),
AHMEDABAD – 380 015.
Tel.: (079) 6134 0555 **INNOVAL**
- 8th Floor, Pinnacle Park Avenue,
Opp. Law College, Law College Road
Next To German Bakery,
Shivaji Nagar, **PUNE** - 411004.
Tel.: (020) 6729 5601 / 600 **INNOVAL**
- Plot No.95, 2nd Floor, Shreyash
Heights, VIP Road, Ramdaspath,
NAGPUR – 440 010.
Tel.: (0712) 2440 900
- 10 B, Prestige Center Court, Office Block,
Vijaya Forum Mall, #183,N.S.K. Salai,
Vadapalani, **CHENNAI** – 600 026.
Tel.: (044) 6612 2800 **INNOVAL**
- J. B. Manjooran Estate,
Door No. 37/3484, 3rd Floor,
Bye Pass Junction, Edappally,
COCHIN – 682 024.
Tel.: (0484) 2801921/6604700 **INNOVAL**
- 204-205, Megapolis Square,
579, M G Road,
INDORE – 452 001.
Tel.: (0731) 49998 91/92/93
- MF-2, Datta's Lords House,
Jamma Chettu Street, Mogalrajapuram,
VIJAYAWADA – 520 010.
Tel.: (0866) 2482393/6393

- Plot No. 359, Saheed Nagar,
2nd Floor,
BHUBANESWAR – 751 007.
Tel.: (0674) 2540 623
- Unit - 1 & 2, Vijay Park,
Main Chakrata Road,
DEHRADUN- 248 001.
Uttarakhand.
Tel.: (0135) 661 6100 **INNOVAL**
- Office No, 509, Sri Kamakhya
Tower, 5th Floor, G S Road,
Christian Basti,
GUWAHATI, Assam - 781006.

Area offices

- SCO 50-51, 2nd Floor Lodhi Club
Road Shaheed Bhagat Singh
Nagar, **LUDHIANA** – 141 013.
Tel.: (0161) 463 8439 **INNOVAL**
- 94, Udhm Singh Sarani,
Ground Floor, Ashrampara,
SILIGURI – 734 001.
Tel.: (353) 264 1067
- A-207, Universal Business
Center, Near Madhvan Circle,
L.P. Savani Road, Adajan,
SURAT - 395 009.
Tel.: (0261) 263 3861 **INNOVAL**
- Aparna Towers, 1st Floor, 2/3,
Bypass Road,
MADURAI – 625 010.
Telefax : (0452) 230 8414
- 43-9-205, 3rd Floor, Plot No. 10,
Subbalakshmi Nagar,
Opp. More Super Market,
VISAKHAPATNAM – 530 016.
Tel.: (0891) 273 5652/9363 **INNOVAL**
- B-5, 1st Floor, Thirumalai Towers,
723, Avanashi Road,
COIMBATORE – 641 018.
Tel.: (0422) 668 3200/222 3634 **INNOVAL**
- 515 & 516, Gera Imperium Grand,
Patto centre ,
Panaji **GOA** – 403 001 **INNOVAL**
- TC 25/3254/6, 1st Floor, Cordial Bharathi
Nanthancodu, **Thiruvanthapuram**,
KERALA- 695 003
Tel.: (0471) 354 5052/353 8935 **INNOVAL**
- 2nd Floor, GND Chambers,
Agrasen Chowk, Samta Colony,
RAIPUR - 492001,Chattisgarh
Tel.: (0771) 4052 400

Technical assistance from Legrand

Telephonic technical assistance for selection of products, technical information, guidance, wiring diagrams and estimation is now made available to you at each Regional Office. Contact the Technical Officer of Legrand at the following telephone numbers

- New Delhi** : Tel.: (011) 3990 2200
Kolkata : Tel.: (033) 4021 3535
Mumbai : Tel.: (022) 6230 1000
Chennai : Tel.: (044) 6612 2800
Hyderabad : Tel.: (040) 4567 1717

For other places, contact the nearest
Regional / Branch / Area offices

customer.care@legrand.co.in

