



# INCARA™



MULTI-FUNCTIONAL,  
ERGONOMIC & SIMPLE TO  
INSTALL SOLUTIONS  
TO LIVE, WORK AND MEET

#LegrandImprovingLives

 **legrand**®



# INCARA



LEGRAND IMPROVING LIVES .....	2/3
INTRODUCING INCARA .....	4/5
INCARA™ DISQ 60.....	6/7
Recharge anywhere, at any time	
INCARA™ DISQ 80.....	8/9
Essential functions for mobile users	
INCARA™ POP-UP .....	10/11
Attractive appearance and easy to use	
INCARA™ FLIP-UP .....	12/13
The premium solution for meeting rooms	
INCARA™ TOP ACCESS .....	14/15
The essential solution for meeting rooms	
INSTALLATION LOCATIONS .....	16/17
CONFIGURED SOLUTIONS .....	18/19
SELECTION GUIDE.....	20/21
CATALOGUE PAGES .....	22/30



# We improve lives

## ABOUT US

Legrand Group is a global specialist in electrical and digital building infrastructure, offering smart solutions across the residential, commercial, hospitality, and industrial sectors. This strong capability has positioned Legrand as the preferred choice of discerning customers in nearly 180 countries worldwide.

### PURPOSE-LED

Our purpose is to improve lives by transforming the spaces where people live, work and meet by delivering electrical and digital infrastructures and connected solutions that are simple, innovative and sustainable.

### CUSTOMER-DRIVEN

Guided by its philosophy of “Listen, Design, Make, and Support”, Legrand closely tracks evolving lifestyles and customer needs. The Group designs high value-added products that seamlessly integrate advanced technology, ergonomic excellence, and refined aesthetics. Through smart ideas, sleek designs, and intuitive simplicity, Legrand aims to help every customer experience a simpler, better quality of life

### CONTINUOUS INNOVATION

Over 2200 people work at our engineering and design offices, innovating simple and sustainable solutions.

### PRODUCT DESIGN – A LEVER FOR DIFFERENTIATION

Design is integral to our overall strategy and lies at the core of everything we do at Legrand. More than aesthetics alone, design is about enhancing the overall customer experience.



# Eco-design: Integrating circular economy principles

## LEGRAND GROUP: FOUR MAIN AREAS OF ACTION TO IMPROVE LIVES

Legrand's corporate social responsibility (CSR) is based on four focal areas which guide and structure its commitments. Published in March 2022, the 2022-2024 CSR roadmap details the 15 priorities the Group has set itself to meet its CSR commitments and challenges, and defines the objectives to be achieved :



LEGRAND HAS BEEN AWARDED THE ECOVADIS PLATINUM MEDAL, THE HIGHEST DISTINCTION AWARDED TO THE TOP 1% OF THE BEST PERFORMING COMPANIES IN TERMS OF CSR AMONG ALL COMPANIES ASSESSED BY ECOVADIS.



### PROMOTE DIVERSITY AND INCLUSION

- Gender diversity
- 'Diversity & Inclusion' labelling
- Employability of Early-in-careers
- Diversity and inclusion among suppliers

### REDUCE OUR CARBON FOOTPRINT

- CO<sub>2</sub> emissions avoided for our customers
- Direct and indirect CO<sub>2</sub> emissions (scopes 1 & 2)
- Indirect CO<sub>2</sub> emissions (scope 3)

### DEVELOP A CIRCULAR ECONOMY

- Use of recycled materials
- Phase out single-use plastic
- Environmental declarations

### BE A RESPONSIBLE BUSINESS

- Customer satisfaction
- Business ethics/compliance
- Employability and skills development
- Safe workplace
- Expanded social coverage

FIND OUT MORE ABOUT OUR CSR STRATEGY

> [www.legrandgroup.com](http://www.legrandgroup.com)

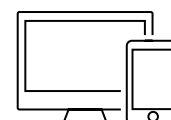

# Introducing Incara

**Incara** is a range of functional and ergonomic wiring devices designed for modern, flexible workspaces from offices and co-working environments to hotels, cafés, airports, and other shared spaces. Developed with both the professional installer and end-user in mind, **Incara** ensures ease of installation, seamless integration, and intuitive day-to-day use. The solutions can be effortlessly incorporated into a wide variety of furniture, enabling immediate access to power and data exactly where it is needed.

With Legrand's expertise in wiring accessories, Incara combines proven quality with a versatile range of functions and finishes. This flexibility allows for easy customisation, ensuring that each installation meets specific workspace requirements. Designed to support evolving work environments, **Incara** enables users to stay connected and productive with minimal effort, delivering both performance and convenience in a refined, modern form.



# Sustainability & environmental performance

## ECO-DESIGN

**Incara** is designed to reduce environmental impact across the product lifecycle, with optimized material use, efficient logistics, and recyclable packaging wherever possible.

## PRODUCT ENVIRONMENTAL PROFILE

With Product Environmental Profiles (PEP), **Incara** provides measurable and transparent data on environmental impact, enabling informed and responsible decision-making.



## A SCALABLE AND SUSTAINABLE SOLUTION

Built with modular functionality, **Incara** allows configurations to be upgraded or replaced as needs evolve. Power and charging options can be adapted without replacing the entire system. This approach extends product lifespan and supports efficient resource use, while enabling better management of workspace power requirements.



## COLOURS, MATERIALS, AND FINISHES

We take our inspiration from a wide variety of sources, including the worlds of electronics, fashion and transport, to design functional products with lasting appeal that are adapted to the environment in which they are used. Made from materials selected for their appearance and performance (impact resistant plastics, high quality aluminium), the **Incara** range offers five different categories of finish.

### TIMELESS

Firm favourites with universal appeal

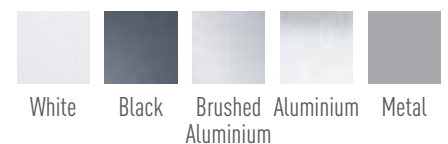

INCARA™

# Disq 60

Recharge anywhere,  
at any time



# Disq 60

**Incara Disq 60** is designed to integrate effortlessly into any environment, combining a clean, flush-mounted design with quick installation and easy access to power and USB charging for everyday convenience.

## MULTIPLE APPLICATIONS

Incara Disq 60 is based on a standard 60 mm cut-out, enabling easy integration. It can be installed both horizontally and vertically on any type of support. The patented Legrand system ensures a secure fit even in thin panels (minimum 1 mm), while the supplied cord equipped with Wieland connector enables quick and reliable connectivity.

## WIDE SELECTION OF FINISHES

Understated, discreet products and finishes that blend in seamlessly with any working environment. The flush socket (patented Legrand system) looks more attractive and is easy to clean.

## TIMELESS FINISHES

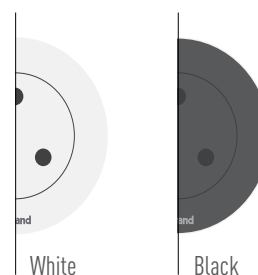

## ESSENTIAL FUNCTIONS WITHIN EASY REACH

2P+E sockets or 15 W USB A+C charger to meet the connection needs of mobile users quickly and easily.

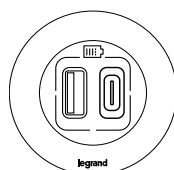

USB A+C charger

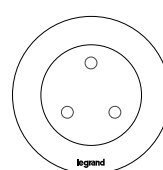

Power socket 6 A



INCARA™

# Disq 80

Essential functions  
for mobile users



# Disq 80

Incara Disq 80 is designed to install effortlessly into modern workspaces, combining essential power, USB charging, and data connectivity in a single compact unit, ensuring seamless access for mobile users.

## QUICK INSTALLATION

The Incara Disq 80 module replaces the existing cable outlet in the furniture (80 mm Ø cut-out).

Supplied with Terminal box for termination



## MODERN DESIGN AND FINISHES

Product designed to blend in seamlessly with any office furniture. The flush socket (patented Legrand system) looks more attractive and is easy to clean.

## TIMELESS FINISHES

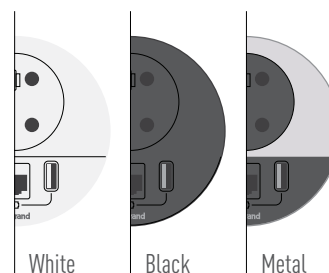

## ESSENTIAL FUNCTIONS IN A COMPACT SPACE

2P+E sockets, 15 W USB A+C charger and RJ 45 Cat. 6 UTP socket or cable outlet to meet the connection needs of mobile users quickly and easily.

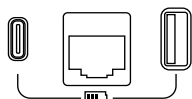

USB A+C charger and RJ 45 socket

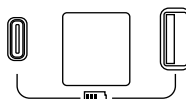

USB A+C charger and Internet Cable Outlet

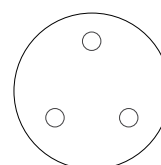

Power socket 6 A



INCARA™

# Pop-up

Attractive appearance  
and easy to use



# Pop-up

**Incara Pop-up** provides real ease of use and quick connection for mobile devices: laptops, smartphones, tablets, audio and video systems, etc. Users have a choice of both power and data connections within easy reach.

## KNOW MORE

Incara Pop-up can take a wide range of functions available in the Arteor Advance range, thus complying with specific requirements, such as fast charging of portable devices. Arteor Advance 30,45, 63/65W USB Type-C Power Delivery chargers are specifically designed to charge all devices even faster. They can optimise charging by automatically selecting the most suitable voltage for the device battery.



USB Type C+C  
White 63/65W Charger

## SLEEK DESIGN

Extra-slim format to blend discreetly into the furniture. The flush-mounted part takes up little space, even allowing installation above a drawer.



## ELEGANT FINISHES

A set of finishes in harmony with both the furniture and the décor.

## TIMELESS FINISHES



## FUNCTIONALITY AND FLEXIBILITY

Available 3, 4, 2x4 and 8-module versions to be equipped.



## SAFETY AND EASE OF USE

Wide button and cover with damper for smooth opening (patented Legrand system). IP44 version (with closed cover) for good protection in the event of accidental contact with liquids, on pop-ups with 4 and 8 modules.



INCARA™

# Flip-up

The premium solution  
for meeting rooms



# FLIP-UP

**I**ncara Flip-up is a premium solution for meeting rooms with its elegant and crisp appearance. Sockets fit discreetly under its cover, even with your devices plugged in.

## EXCELLENT STRENGTH AND EASE OF USE

With its simple push-to-open mechanism, the cover slides inside the product and the socket unit rises up (patented Legrand system). Access to the sockets is on both sides, making it an ideal solution for meeting rooms.

## 100% METAL FINISH

Metal cover, frame and cable gland plate for a sleek design which blends in harmoniously and creates a unique result.

The equipment is available in empty as well as preconfigured version.

## COLOURS

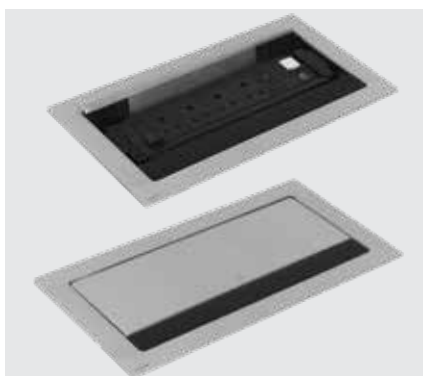
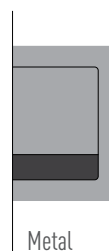

The retractable system has been tested up to 18,000 operations. Incara Flip-up is available in 8 or 12 modules.

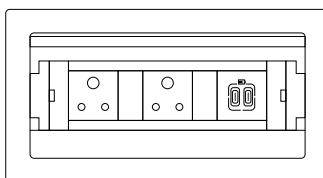

8 modules

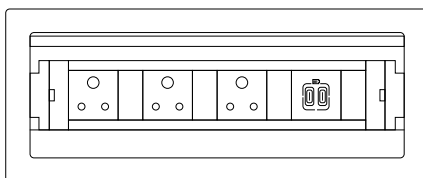

12 modules

## KNOW MORE

The quick-fixing system saves a great deal of installation time (Legrand patented system). No tools required.



INCARA™

# Top Access

The essential solution  
for meeting rooms



# Top Access

**Incara Top Access** enables discreet, easy storage for Desktop Power Center, Legrand surface box with accessories, DLP with accessories or equivalent product that can accommodate chargers and wires.

## SIMPLICITY OF USE

With its integral basket, Incara Top Access can accommodate and conceal all electrification solutions. To ensure soft closing, the cover is fitted with a damper.

Available in 2 sizes:

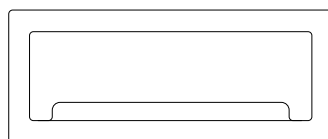

295 mm wide

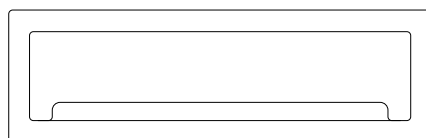

385 mm wide

## AVAILABLE FINISHES

A choice of three finishes for seamless integration in workspaces.

## TIMELESS FINISHES

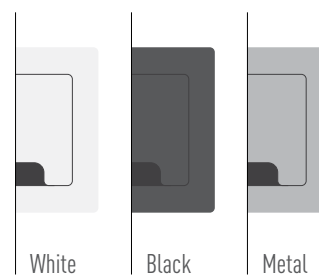

## KNOW MORE

Incara Top Access is equipped with integral basket. Desktop Power Center, Legrand surface box with accessories, DLP with accessories or equivalent product that can accommodate chargers and wires.



# Installation Locations



OFFICES	Incara Disq 60	Incara Disq 80
COLLABORATIVE SPACES	☆	•
SHARED OFFICES	-	☆
PRIVATE OFFICES	-	•
ACOUSTIC BOOTHS	•	•
MEETING ROOMS	-	•
HOTELS		
COMMON AREAS	☆	•
BEDROOMS	•	☆
MEETING ROOMS	-	•
PUBLIC SPACES		
EDUCATION	•	☆
LIBRARY	☆	•
TRANSPORT	•	☆
CAFÉ	•	•
SHOPS	☆	•
RESIDENTIAL		
KITCHEN	•	-
HOME OFFICE	-	☆



Incara Pop-up	Incara Pop-up (IP44)	Incara Flip-up	Incara Top Access
•	•	-	-
•	•	-	-
☆	☆	-	•
•	-	-	-
☆	•	☆	☆
•	-	-	-
•	-	-	-
•	•	☆	☆
•	-	•	•
•	-	•	•
•	•	-	-
-	☆	-	-
•	-	-	-
☆	☆	-	-
•	•	-	-

# INCARA™

# Configured Solutions

## TO MEET ALL YOUR NEEDS

The configuration and customisation options available with the Incara range mean that it can be adapted to any environment or application, meeting your most challenging requirements.

- Choose the colours to suit your furniture or customise your work spaces
- Configure the products from among 250+ Arteor Advance programme functions
- Adapt the type of power supply, the length of the power cord or the dimensions of your products

### TOP ACCESS

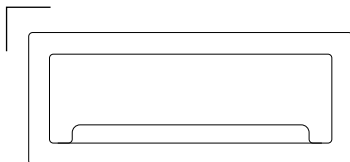

295 mm wide

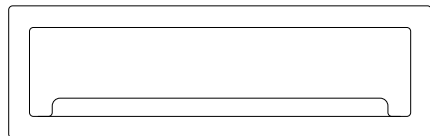

385 mm wide

### FLIP UP

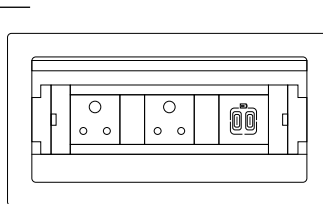

8 modules

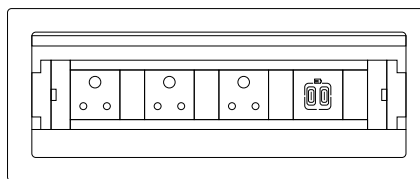

12 modules

### DISQ

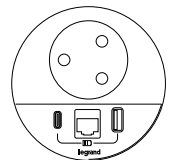

Disq-80

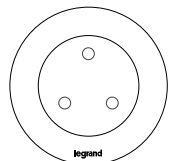

Disq-60

### POP UP

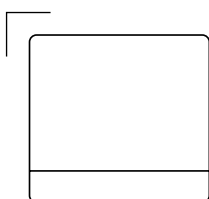

3 modules

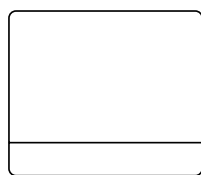

4 modules

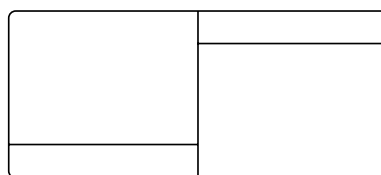

2X4 modules

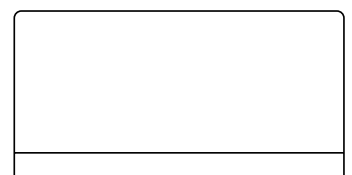

8 modules

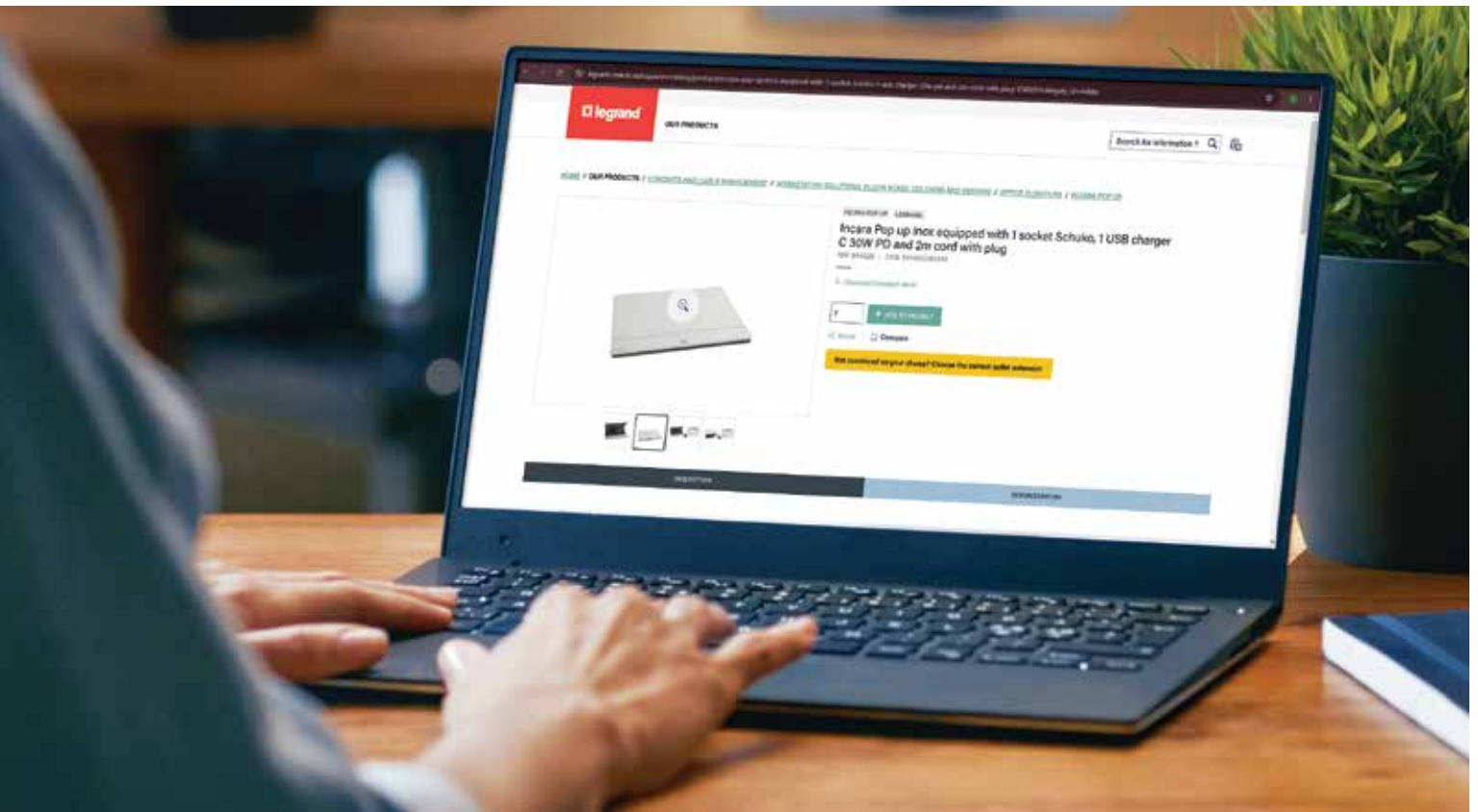

# ARTEOR™ ADVANCE

Arteor Advance offers a choice of functions from its range. Choosing Arteor Advance means opting for a stylish, reliable, and standard stocked range of products that are easy to install.

More than 250 functions in a 45x45 format can be integrated into any support. All the main functions can be integrated into the Incara range.

## Power Socket



## Data/AV



## USB Chargers



# INCARA™

## Selection Guide

### Incara™ Disq 60

	CAPACITY	FUNCTION	FINISH	
			White	Black
	<b>With 0.5 m cord + Wieland connector</b>			
	1 x 2P+E socket		6 540 32	6 540 29
	1 x 15 W USB A+C charger		6 540 30	6 540 31

### Incara™ Disq 80

	CAPACITY	FUNCTION	FINISH		
			White	Black	Black+ Metal
	<b>With terminal box for termination</b>				
	1 x 2P+E socket + 1 USB A+C charger + 1 x RJ 45 Cat. 6 UTP socket		6 540 34	6 540 37	6 540 40
	1 x 2P+E socket + 1 USB A+C charger + 1 x cable outlet		6 540 33	6 540 36	6 540 39

### Incara™ Pop up

	CAPACITY	FUNCTION	FINISH			
			White	Black	Aluminium	Brushed Aluminium
	<b>To be equipped version</b>					
	3 modules		6 548 46	6 548 47	6 548 48	6 548 45
	4 modules		6 548 01	6 548 02	6 548 03	6 548 00
	4 modules IP 44		-	-	-	6 548 12
	8 modules		6 548 09*	6 548 10	6 548 11	6 548 08
	2 x 4 modules		6 548 05*	6 548 06*	6 548 07*	6 548 04*

\* Incara Pop-up boxes are available in the empty version. Only Arteor Advance range accessories can be fixed in the INCARA Pop-Up

## Incara™ Flip-up

CAPACITY	FUNCTION	FINISH		
		White	Black	Aluminium
<b>To be Equipped with terminal box for cable termination</b>				
8 modules	Flip up 8 modules metal empty			6 540 22*
12 modules	Flip up 12 modules metal empty			6 540 23*
<b>Pre-Equipped with terminal box for cable termination (White Arteor Advance Accessories)</b>				
8 modules	1 X 6A switch + 2 x 6A 2P+E sockets + 1 x 15 W USB C+C charger + 1 x HDMI socket			6 540 24
	1 X 6A switch + 2 x 6A 2P+E sockets + 1 x 15 W USB C+C charger + 1 x HDMI socket + 1 x RJ 45 Cat. 6 UTP sockets			6 540 25
12 modules	1 X 6A switch + 4 x 6A 2P+E sockets + 1 x 15 W USB C+C charger + 1 x HDMI socket			6 540 26
	1 X 6A switch + 4 x 6A 2P+E sockets + 1 x 15 W USB C+C charger + 1 x HDMI socket + 1 x RJ 45 Cat. 6 UTP sockets			6 540 27

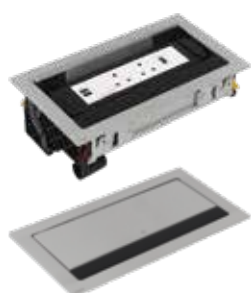

\*Only Arteor Advance range accessories can be fixed in the INCARA flip-up.

## Incara™ Top Access (to be equipped with an office module)

CAPACITY	FUNCTION	FINISH		
		White	Black	Aluminium
8 modules		6 548 71	6 548 72	6 548 70
12 modules		6 548 74	6 548 75	6 548 73



TOP ACCESS  
OTHER VARIANTS



6 548 72



6 548 71



6 548 75



6 548 73



6 540 29



6 540 32



6 540 30



6 540 31

**Dimensions (mm)**

**Incara™ Disq 60**

Cat.Nos 6 540 29 / 6 540 32

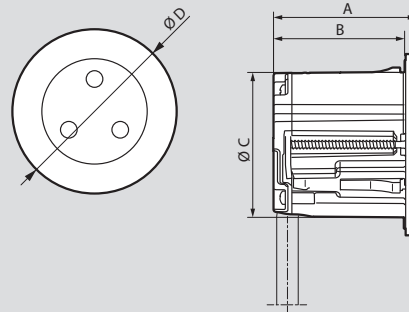

A	B	C	D
54.5	50	59	74

Technical characteristics **see opposite**

For flush mounting in furniture in Ø60 mm cut-out

Three methods of installation:

- Flush mounting in the furniture (desk), 6-40 mm thickness
- Flush mounting on a soft surface (armchair, sofa) using a dedicated accessory
- Flush mounting on a metal panel, 1 mm thickness (locker)

Conform to standard BS 5733

Pack	Cat.No	2P+E sockets
1	6 540 32	6 A 240 V~ 50/60 Hz Sockets specially designed for passageways (10,000 operations) and equipped and safety shutters Conform to standard IS 1293 <b>With 0.5 m cord and GST18i3 Wieland connector</b> ○ White finish
1	6 540 29	● Black finish <b>With 2 m cord and 2P+E plug</b>
1	6 540 30	<b>15 W USB Type-A + Type-C chargers</b> Power supply: 110-240 V~ 50/60 Hz Conform to standard IEC 62368-1 <b>With 0.5 m cord and GST18i3 Wieland connector</b> ○ White finish
1	6 540 31	● Black finish

**Positioning**

**Installing in office furniture**

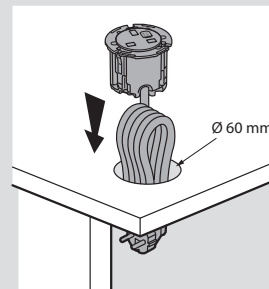

**Drilling dimensions**

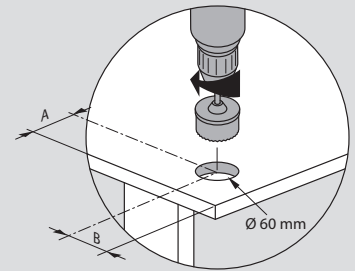

A > 95 | B > 95

**Installing in metal furniture such as a locker**

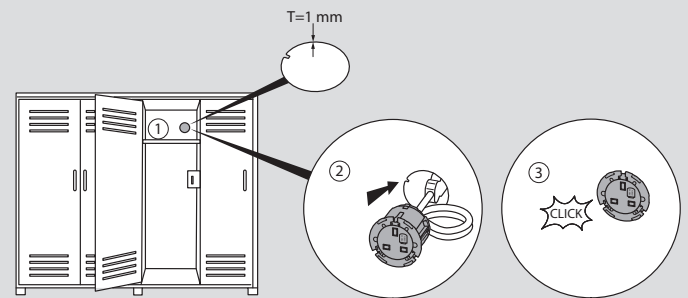

**Installing in a sofa**

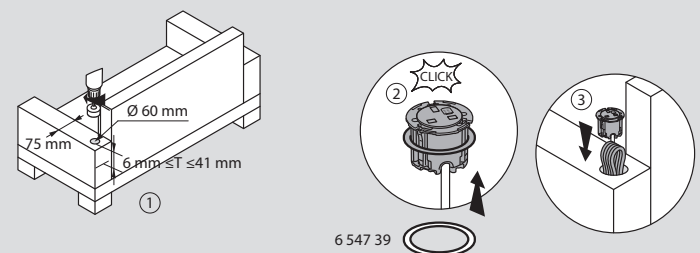

# Incara™ Disq 80

for offices and collaborative spaces

# Incara™ Disq 80

technical characteristics



6 540 40



6 540 37



6 540 34



6 540 39



6 540 36



6 540 33

Technical characteristics **see opposite**

For flush mounting in furniture, 1-40 mm thickness, in Ø79 mm cut-out

Conform to standard BS 5733

RJ 45 socket: feedthrough socket

2P+E sockets conforming to standard BS 1363-2

USB chargers conforming to standard IEC 62368-1

Pack	Cat.No	2P+E socket + 15 W USB Type-A + Type-C charger + RJ 45 cat. 6 UTP socket
1	6 540 40	● Metal finish
1	6 540 34	○ White finish
1	6 540 37	● Black finish

2P+E sockets: 6A 240 V~ 50/60 Hz  
 USB chargers: 110/240 V~ 50/60 Hz power supply  
 Sockets specially designed for passageways (10,000 operations), equipped with 5 A fuse and safety shutters  
**With Equipped with a terminal box for electrical termination**

Pack	Cat.No	2P+E flush socket + 15 W USB Type-A + Type-C charger + cable outlet
1	6 540 39	● Metal finish
1	6 540 33	○ White finish
1	6 540 36	● Black finish

2P+E sockets: 6A 240 V~ 50/60 Hz  
 USB chargers: 110/220 V~ 50/60 Hz power supply  
 Sockets specially designed for passageways (10,000 operations), equipped with 5 A fuse and safety shutters  
**Equipped with a terminal box for electrical termination**

## ■ Dimensions (mm)

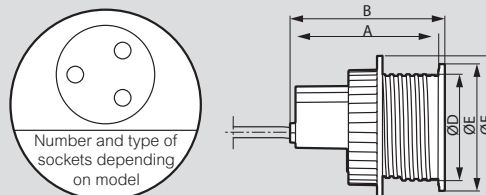

Cat.Nos	A	B	C	D	E	F
6 540 40/6 540 34/6 540 37	109	113	- 115	78	93	105

## ■ Positioning

Installing in a desk

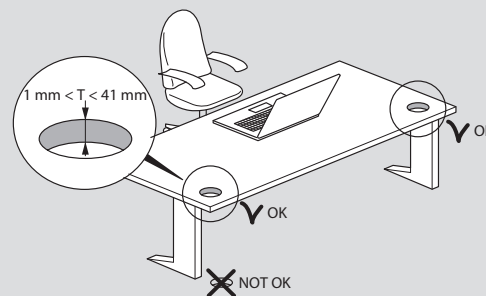

## ■ Drilling dimensions

Incara™ Disq 80

Cat.Nos 6 540 40/6 540 34/6 540 37/ 6 540 39/ 6 540 36/ 6 540 33

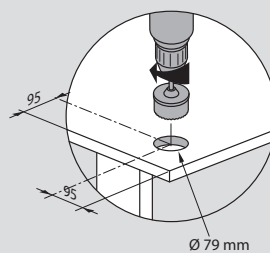

## ■ Insertion

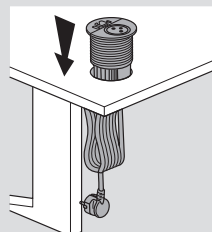

# Incara™ Pop-up

for offices and meeting rooms

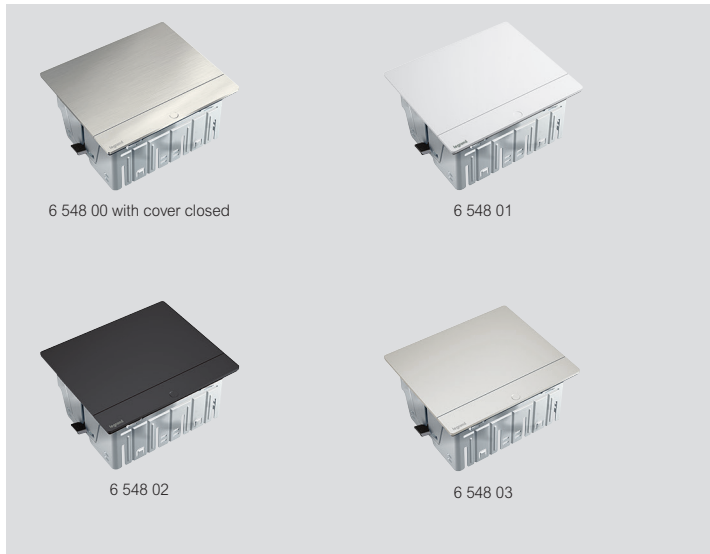

**Technical characteristics p. 19**

For flush mounting in furniture, compatible desktop thickness 15 to 40 mm Metal. Protective film  
Conform to standard BS 5733

Pack	Cat.No	Incara™ Pop-up to be equipped
		To be equipped with Arteor Advance functions
		<b>3 modules</b>
1	6 548 45	○ Brushed Aluminium
1	6 548 46	○ White
1	6 548 47	● Black
1	6 548 48	● Aluminium
		<b>4 modules</b>
1	6 548 00	○ Brushed Aluminium
1	6 548 01	○ White
1	6 548 02	● Black
1	6 548 03	● Aluminium
		<b>2 x 4 modules</b>
1	6 548 04	○ Brushed Aluminium
1	6 548 05	○ White
1	6 548 06	● Black
1	6 548 07	● Aluminium
		<b>8 modules</b>
1	6 548 08	○ Brushed Aluminium
1	6 548 09	○ White
1	6 548 10	● Black
1	6 548 11	● Aluminium
		<b>4 modules IP 44</b>
1	6 548 12	○ Brushed Aluminium

## ■ Uses

Incara™ Pop up is a modern and aesthetic solution to bring power and data to the workstation and meeting room. Available with 4, 8 or 2x4 modules, Incara™ Pop up is available to be equipped with power, data or A/V functions from the Arteor Advance range. The 4 modules version is also available in IP44 and to be equipped only

## ■ Technical Characteristics

### ■ Mechanical Characteristics

Resistance to Impact: IK 07 (part on desk)  
IK 04 (part under desk)

Degree of protection provided by housings:  
IP 44 for no 6 548 12  
IP 20 for the others other car references

### ■ Material Characteristics

Wiring devices frame: Aluminium, Zamak, ABS  
Insulation box: PC-ABS  
Mounting frame: Steel

## ■ Cleaning

Superficial cleaning with a soft cloth. Do not use abrasive products or detergents.

Caution: Always test before using other special cleaning products.

## ■ Standards and Approvals

Compliant to BS 5733

# Incara™ Pop-up

technical characteristics

## ■ Dimensions

### 3 modules

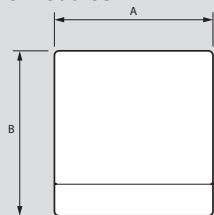

Cat.Nos	A	B
6 548 45/46/47/48	123	125

### 4 modules

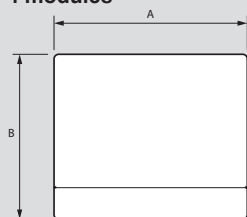

Cat.Nos	A	B
6 548 00/01/02/03/12	146	125

### 2X4 modules

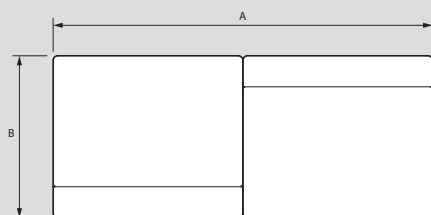

Cat.Nos	A	B
6 548 04/05/06/07/18/19/24/25	282	125

### 8 modules

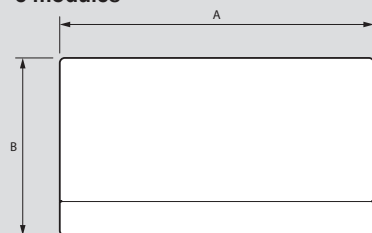

Cat.Nos	A	B
6 548 08/09/10/11	236	125

### Open on the desk

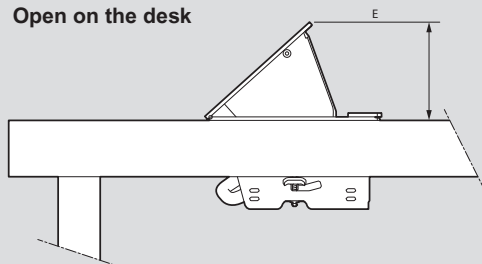

Cat.Nos	E
6 548 00/01/02/03/04/05/06/07/08/09/10/11/12/45/46/47/48	70

### Closed on the desk

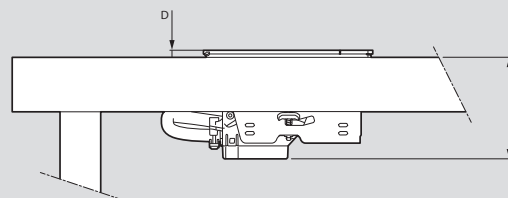

Cat.Nos	C	D
6 548 00/01/02/03/04/05/06/07/08/09/10/11/12/45/46/47/48	75	5.2

### Cut-out for corners

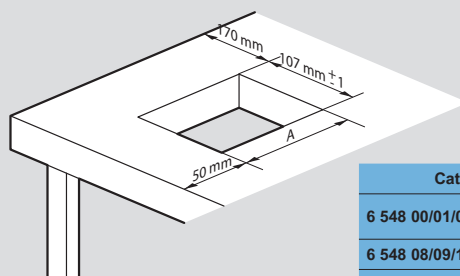

Cat.Nos	A
6 548 00/01/02/03/12	129 mm ± 1
6 548 08/09/10/11	219 mm ± 1
6 548 45/46/47/48	106 mm ± 1
6 548 04/05/06/07	265 mm ± 1



**Note:** For other cut-outs: see the product data sheet available with the product

## ■ Dimensions on the underside of the desk

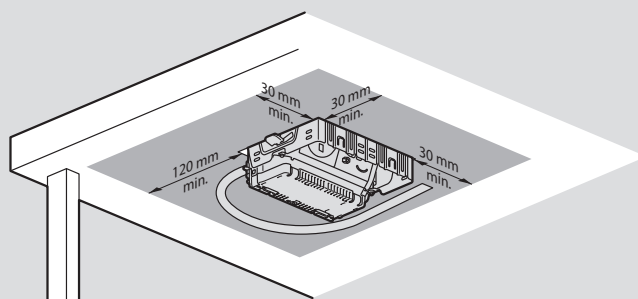

## ■ Insertion

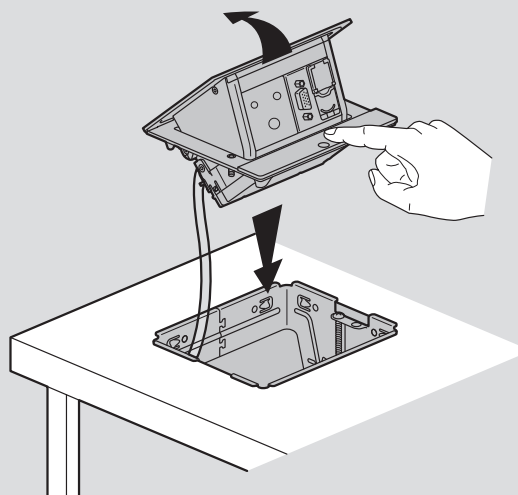

# Incara™ Flip-up

for meeting rooms

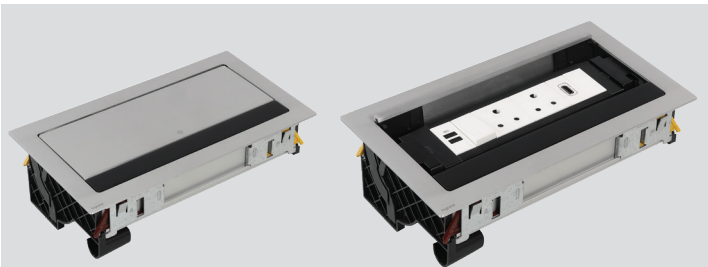

6 540 24 with cover closed and cover open

## Technical characteristics p. 21

For flush mounting in furniture, compatible table thickness 15 to 40 mm  
 Ready to use  
 Max. power: 3680 W at 230 VA  
 6A switch conforming to standard IS 3854 : 1997  
 6A 2P+E sockets: 250 VA 50/60 Hz, equipped with safety shutters, conforming to standard IS 1293: 2019  
 USB chargers: 240 VA 50/60 Hz power supply, conforming to standard IEC 60950-1  
 low voltage directive and Conforming IS 13252(Part-1) : 2010+A1 : 2013+A2 :2015.

Pack	Cat.No	Incara™ Flip-up to be Equipped
1	6 540 22	Flip up 8 Modules Metal Empty
1	6 540 23	Flip up 12 Modules Metal Empty
<b>Incara™ Flip-up pre Equipped (Arteor Advance White)</b>		
<b>8 power modules</b> Composition: - 1 X 6A switch - 2 x 6A 2P+E sockets - 1 x 15 W USB C+C charger + 1 x HDMI socket ● Metal finish		
1	6 540 24	1 X 6A switch + 2 x 6A 2P+E sockets + 1 x 15 W USB C+C charger + 1 x HDMI socket
<b>8 power and data modules</b> Composition: - 1 X 6A switch - 2 x 6A 2P+E sockets - 1 x 15 W USB C+C charger + 1 x HDMI socket - 1 x RJ 45 Cat. 6 UTP sockets ● Metal finish		
1	6 540 25	1 X 6A switch + 2 x 6A 2P+E sockets + 1 x 15 W USB C+C charger + 1 x HDMI socket + 1 x RJ 45 Cat. 6 UTP sockets
<b>12 power modules</b> Composition: - 1 X 6A switch - 4 x 6A 2P+E sockets - 1 x 15 W USB C+C charger + 1 x HDMI socket ● Metal finish		
1	6 540 26	1 X 6A switch + 4 x 6A 2P+E sockets + 1 x 15 W USB C+C charger + 1 x HDMI socket
<b>12 power and data modules</b> Composition: - 1 X 6A switch - 4 x 6A 2P+E sockets - 1 x 15 W USB C+C charger + 1 x HDMI socket - 1 x RJ 45 Cat. 6 UTP sockets ● Metal finish		
1	6 540 27	1 X 6A switch + 4 x 6A 2P+E sockets + 1 x 15 W USB C+C charger + 1 x HDMI socket + 1 x RJ 45 Cat. 6 UTP sockets

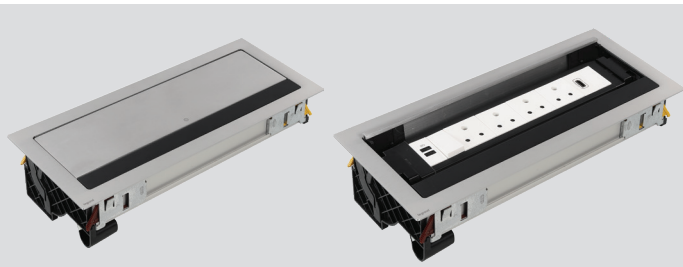

6 540 26 with cover closed and cover open

## Uses

Designed for meeting room tables, Incara™ Flip Up provides users with power, data and audio-video in a functional and aesthetic way. A simple pressure on the cover triggers an automatic opening of the product giving access to the sockets from both sides of the table and, once all devices are connected, the cover can be closed. Incara™ Flip Up is available in 2 sizes and metal finish.

## Technical Characteristics

- Mechanical Characteristics
  - Resistance to Impact: IK 07
  - Degree of protection provided by enclosures: IP 30
- Material Characteristics
  - Housing + Rotating Mechanism: ABS
  - Housing: Galvanised Steel (Z275) Aluminium
  - Multi-outlet: black anodised aluminium
  - Finishing frames: Metal Finish

## Climate Characteristics

Operating temperature: from - 5°C to +35°C  
 Storage temperature: from - 10°C to +70°C

## Cleaning

Superficial cleaning with a soft cloth. Do not use abrasive products or detergents.

Caution: Always test before using other special cleaning products.

## Standards and Approvals

Compliant to BS 5733

# Incara™ Flip-up

technical characteristics

## ■ Dimensions (mm)

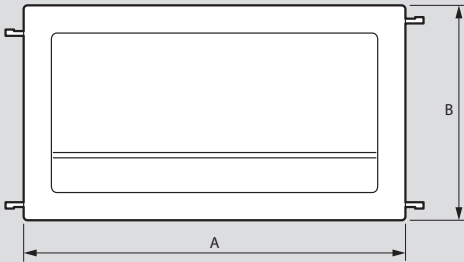
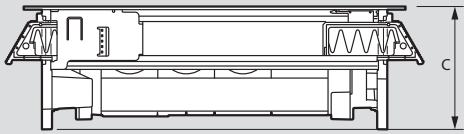

Cat.Nos	A	B	C
6 540 22/24/25	303	170.5	97.5
6 540 23/26/27	393		

## ■ Installing on a desktop

Drilling dimensions and maximum cut-out radius in corners

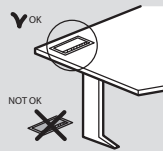
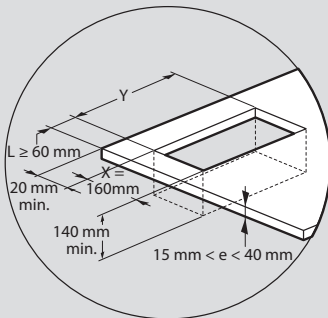

Cat.Nos	Y ± 1 mm
6 540 22/24/25	286
6 540 23/26/27	376

**Note:** For other cut-outs: see the product data sheet available product data sheet available with product

## CNC machining cut-out

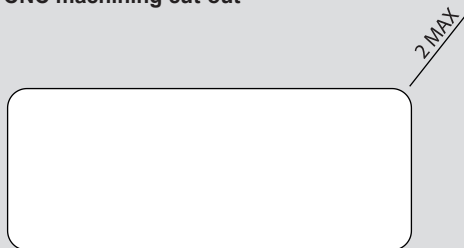

## ■ Use

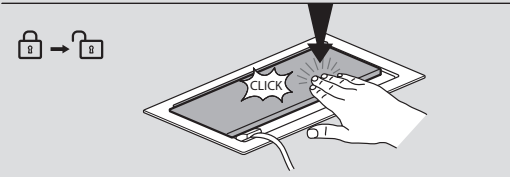
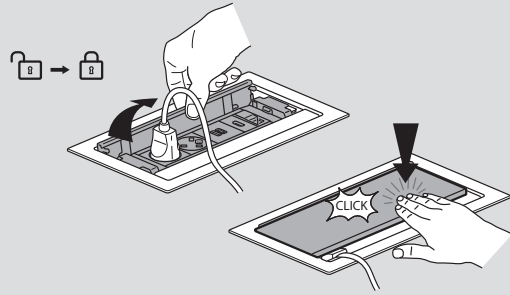

## ■ Insertion and fixing

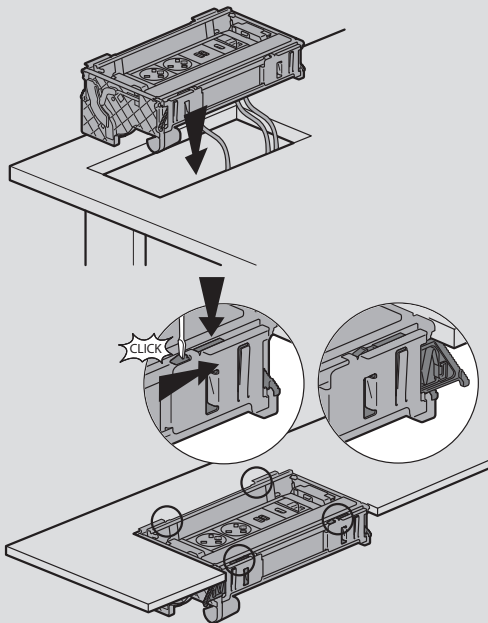

# Incara™ Top Access

for offices and meeting rooms

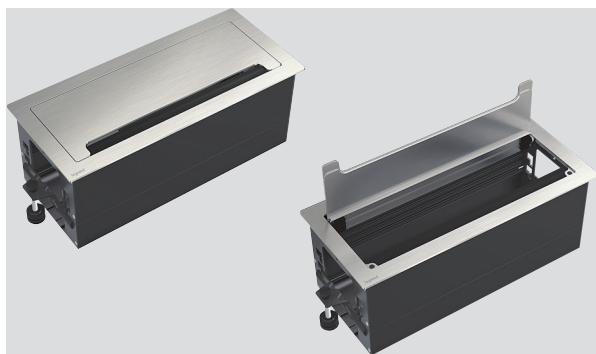

6 548 70 with cover closed and cover open



6 548 74 with cover closed and cover open

## Technical characteristics p. 23

For flush mounting in furniture, compatible table thickness 10 to 40 mm

Metal

Easy storage for an office module, multi-outlet or surplus cable in the workspace

Features a dedicated fixing system for Legrand office modules

Pack	Cat.No	Incara™ Top Access
		<b>295 mm size</b>
1	6 548 70	● Metal
1	6 548 71	○ White
1	6 548 72	● Black
		<b>385 mm size</b>
1	6 548 73	● Metal
1	6 548 74	○ White
1	6 548 75	● Black

## Uses

Incara™ Top Access is a desk-mounted solution that provides easy and discreet storage for cables, cords, and mobile multi-outlets. It is an ideal addition to Incara™ Top Access, Desktop Power Center, Legrand Surface box with accessories, DLP with accessories or equivalent product that can accommodate chargers and wires.

## Installation precaution

Must not be fitted on the floor.  
Installation into the desk

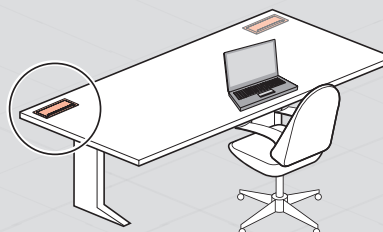

## Technical Characteristics

- Mechanical Characteristics
  - Resistance to impacts: IK 07
- Material Characteristics
  - Basket: Mat black color painted
  - Fixing brackets: Steel

## Climate characteristics

Operating temperature: from -5°C to +35°C  
Storage temperature: from -10°C to +70°C

## Cleaning

Superficial cleaning with a soft cloth. Do not use abrasive products or detergents.

Caution: Always test before using other special cleaning products.

# Incara™ Top Access

technical characteristics

## ■ Dimensions (mm)

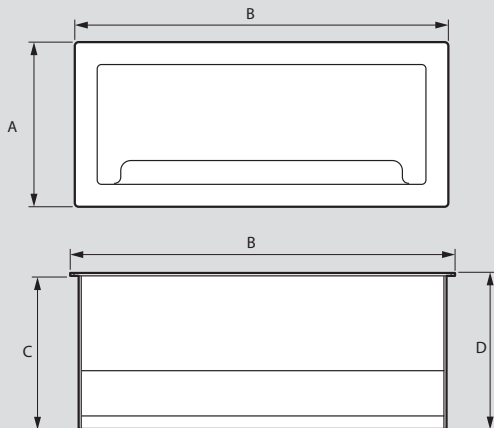

	A	B	C	D
Incara™ Top Access 295	130	295	120	122.2
Incara™ Top Access 385		385		

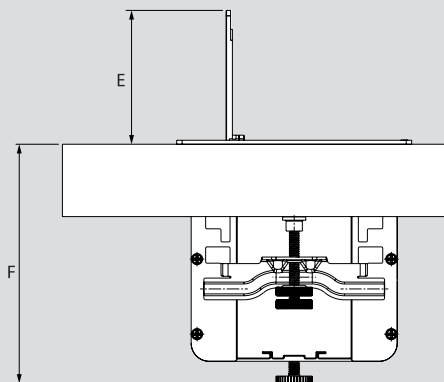

E	F
74	132.19

## ■ Cut-out for corners

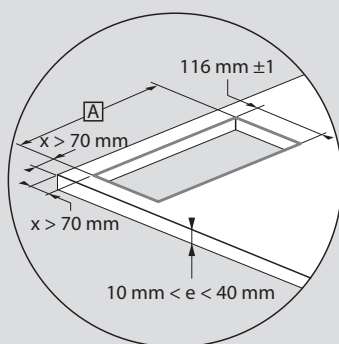

	6 548 70/71/72	6 548 73/74/75
A	$284 \text{ mm} \pm 1$	$374 \text{ mm} \pm 1$

**Note:** For other cut-outs: see the product data sheet available product data sheet available with product.

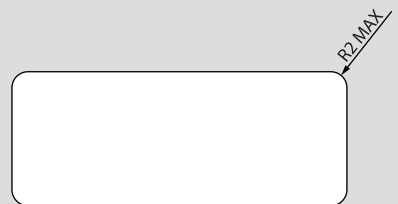
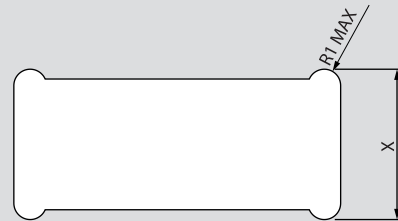

X	R1 MAX	R2 MAX
122	6	3

## ■ Insertion and fixing

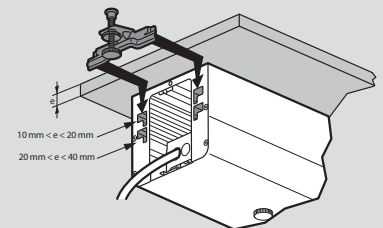
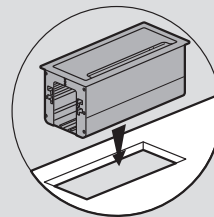

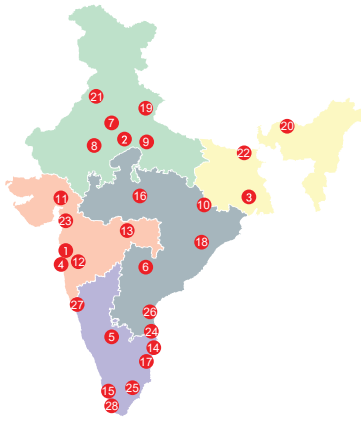

## Head offices

- 61 & 62, 6<sup>th</sup> Floor,  
Kalpataru Square, Kondivita Road,  
Off Andheri-Kurla Road, Andheri (E),  
**MUMBAI** – 400 059.  
Tel.: (022) 3041 6200  
Fax : (022) 3041 6201  
Website : [www.legrand.co.in](http://www.legrand.co.in)

## Regional sales offices

- B-225, 4<sup>th</sup> Floor, Okhla Industrial Area, Phase -1,  
**NEW DELHI** - 110020.  
Tel.: (011) 3990 2200 [INNOVAL](#)
- Ecocenter Ambuja Neotia,  
Block - EM-04, 12<sup>th</sup> Floor,  
Unit - 1203, Sector - V, Salt Lake,  
**KOLKATA** – 700 091.  
Tel.: (033) 4021 3535 / 3536 [INNOVAL](#)
- C/203, Corporate Avenue, Atul Projects,  
Near Mirador Hotel, Chakala,  
Andheri - Ghatkopar Link Road,  
Andheri - (E), **MUMBAI** – 400 099.  
Tel.: (022) 6230 1000 [INNOVAL](#)
- Ferozes Manor, 1<sup>st</sup> Floor, No. 58,  
Bowring Hospital Road,  
**BANGALORE** – 560 001.  
Tel.: (080) 80682 20000 [INNOVAL](#)
- Prestige Phoenix, 1<sup>st</sup> Floor,  
Survey number 199,  
Door No. 6-3-1219/J/101 & 102,  
Begumpet, **HYDERABAD**,  
Telangana - 500 016  
Tel.: (040) 4567 1717/2341 4398/234 14367 [INNOVAL](#)

## Technical assistance from Legrand

Telephonic technical assistance for selection of products, technical information, guidance, wiring diagrams and estimation is now made available to you at each Regional Office. Contact the Technical Officer of Legrand at the following telephone numbers

- New Delhi** : Tel.: (011) 3990 2200  
**Kolkata** : Tel.: (033) 4021 3535  
**Mumbai** : Tel.: (022) 6230 1000  
**Chennai** : Tel.: (044) 6612 2800  
**Hyderabad** : Tel.: (040) 4567 1717

For other places, contact the nearest Regional / Branch / Area offices

[customer.care@legrand.co.in](mailto:customer.care@legrand.co.in)

## Branch offices

- Bestech Business Tower  
Unit no. 203, 2nd floor  
Tower -B, Sector -66,  
**MOHALI**- 160 062  
Tel.: (0172) 5019 008/ 4635 145 [INNOVAL](#)
- 128, Mohan Nagar besides  
Riddhi Siddhi Flyover, **JAIPUR** - 302019  
Tel.: 0141-220 8665 [INNOVAL](#)
- 209-A, 2<sup>nd</sup> Floor, Cyber Heights,  
Opp. Indira Gandhi Pratishthan,  
Vibhuti Khand, Gomti Nagar,  
**LUCKNOW** - 226 010.  
Tel.: (0522) 457 5427 [INNOVAL](#)
- 202 & 203, Sunrise, Forum 100,  
Burdwan Compound, Lalpur,  
**RANCHI** - 834 001.  
Tel.: (651) 660 5400
- A 101-102, Mondeal Heights,  
Besides Novotel Hotel, Sarkhej  
Gandhinagar Highway (S G Highway),  
**AHMEDABAD** – 380 015.  
Tel.: (079) 6134 0555 [INNOVAL](#)
- 8<sup>th</sup> Floor, Pinnacle Park Avenue,  
Opp. Law College, Law College Road  
Next To German Bakery,  
Shivaji Nagar, **PUNE** - 411004.  
Tel.: (020) 6729 5601 / 600 [INNOVAL](#)
- Plot No.95, 2<sup>nd</sup> Floor, Shreyash  
Heights, VIP Road, Ramdaspath,  
**NAGPUR** – 440 010.  
Tel.: (0712) 2440 900
- 10 B, Prestige Center Court, Office Block,  
Vijaya Forum Mall, #183,N.S.K. Salai,  
Vadapalani, **CHENNAI** – 600 026.  
Tel.: (044) 6612 2800 [INNOVAL](#)
- J. B. Manjooran Estate,  
Door No. 37/3484, 3<sup>rd</sup> Floor,  
Bye Pass Junction, Edappally,  
**COCHIN** – 682 024.  
Tel.: (0484) 2801921/6604700 [INNOVAL](#)
- 204-205, Megapolis Square,  
579, M G Road,  
**INDORE** – 452 001.  
Tel.: (0731) 49998 91/92/93
- MF-2, Datta's Lords House,  
Jamma Chettu Street, Mogalrajapuram,  
**VIJAYAWADA** – 520 010.  
Tel.: (0866) 2482393/6393
- Plot No. 359, Saheed Nagar,  
2<sup>nd</sup> Floor,  
**BHUBANESWAR** – 751 007.  
Tel.: (0674) 2540 623
- Unit - 1 & 2, Vijay Park,  
Main Chakrata Road,  
**DEHRADUN**- 248 001.  
Uttarakhand.  
Tel.: (0135) 661 6100 [INNOVAL](#)
- Office No, 509, Sri Kamakhya  
Tower 5th Floor, G S Road,  
Christian Basti, **GUWAHATI**,  
Assam– 781 006.

## Area offices

- SCO 50-51, 2<sup>nd</sup> Floor Lodhi Club  
Road Shaheed Bhagat Singh  
Nagar, **LUDHIANA** – 141 013.  
Tel.: (0161) 463 8439 [INNOVAL](#)
- 94, Udham Singh Sarani,  
Ground Floor, Ashrampara,  
**SILIGURI** – 734 001.  
Tel.: (353) 264 1067
- A-207, Universal Business  
Center, Near Madhuvan Circle,  
L.P. Savani Road, Adajan,  
**SURAT** – 395 009.  
Tel.: (0261) 263 3861 [INNOVAL](#)
- Aparna Towers, 1<sup>st</sup> Floor, 2/3,  
Bypass Road,  
**MADURAI** – 625 010.  
Telefax : (0452) 230 8414
- 43-9-205, 3<sup>rd</sup> Floor, Plot No. 10,  
Subbalakshmi Nagar,  
Opp. More Super Market,  
**VISAKHAPATNAM** – 530 016.  
Tel.: (0891) 273 5652/9363 [INNOVAL](#)
- B-5, 1<sup>st</sup> Floor, Thirumalai Towers,  
723, Avanashi Road,  
**COIMBATORE** – 641 018.  
Tel.: (0422) 668 3200/222 3634 [INNOVAL](#)
- 515 & 516, Gera Imperium Grand,  
Patto centre ,  
Panaji **GOA** – 403 001 [INNOVAL](#)
- TC 25/3254/6, 1st Floor,Cordial Bharathi  
Nanthancodu, **Thiruvanthapuram**,  
KERALA- 695 003  
Tel.: (0471) 354 5052/353 8935 [INNOVAL](#)
- 2<sup>nd</sup> Floor, GND Chambers,  
Agrasen Chowk, Samta Colony,  
**RAIPUR** - 492001,Chattisgarh  
Tel.: (0771) 4052 400

