

# RETAIL PRICELIST 2026

Built on trust,  
Growing together



# Smart Innovation: Around The World

Legrand Group is a global specialist in electrical and digital building infrastructure, offering smart solutions across the residential, commercial, hospitality, and industrial sectors. This strong capability has positioned Legrand as the preferred choice of discerning customers in nearly 180 countries worldwide.

Our purpose is to improve lives by transforming the spaces where people live, work and meet by delivering electrical and digital infrastructures and connected solutions that are simple, innovative and sustainable.

Guided by its philosophy of “Listen, Design, Make, and Support”, Legrand closely tracks evolving lifestyles and customer needs. The Group designs high value-added products that seamlessly integrate advanced technology, ergonomic excellence, and refined aesthetics. Through smart ideas, sleek designs, and intuitive simplicity, Legrand aims to help every customer experience a simpler, better quality of life.

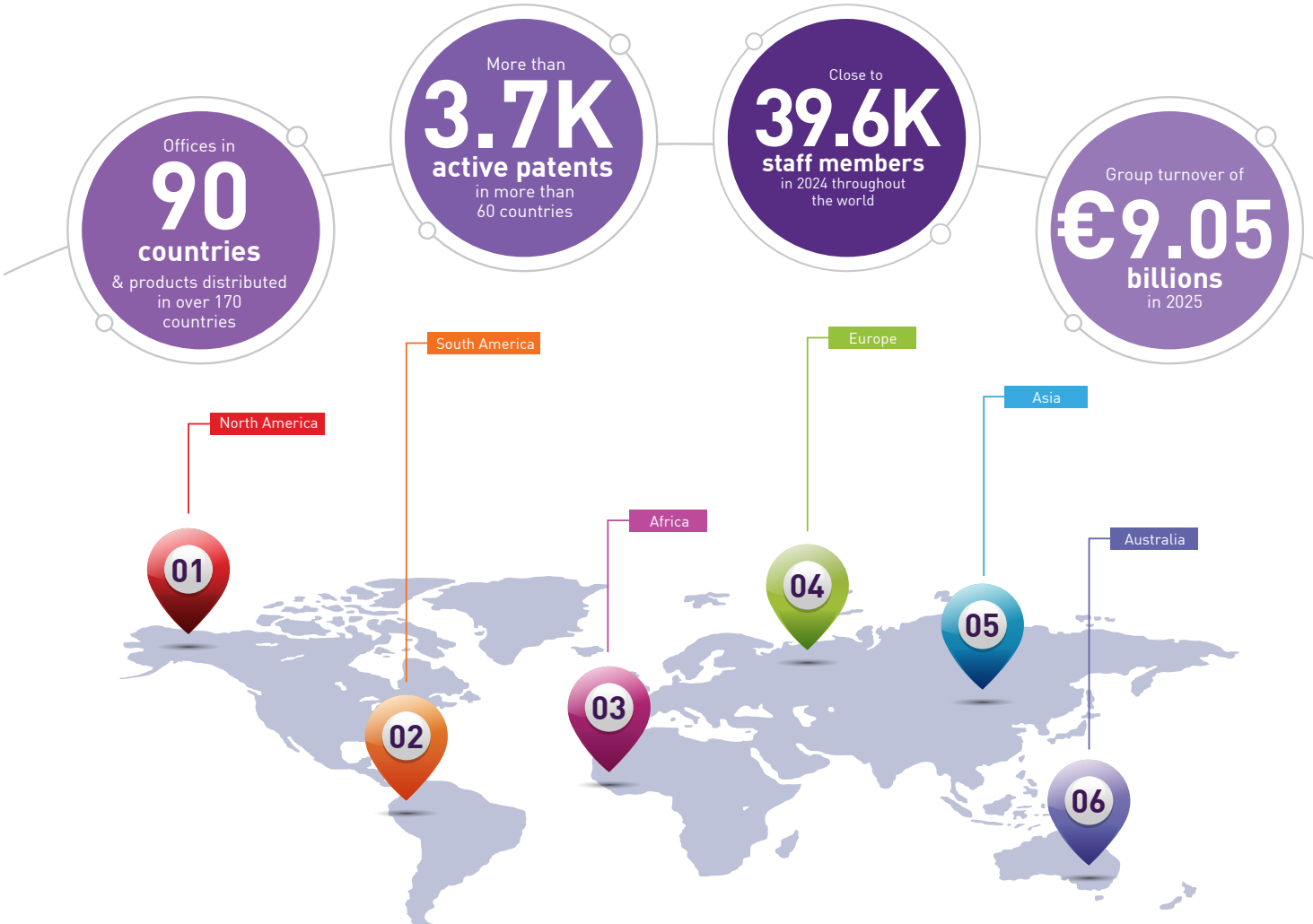

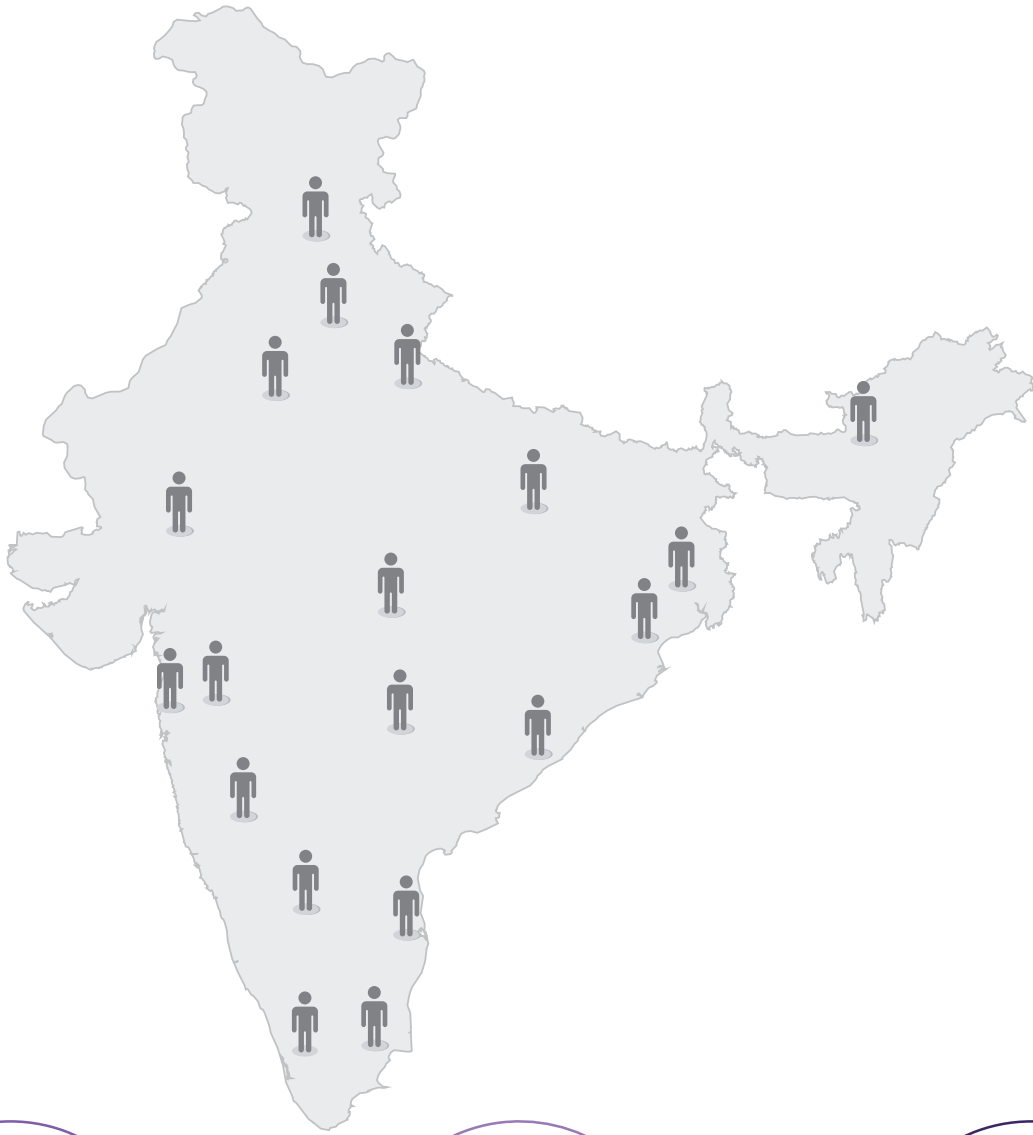

**91+ OFFICES**  
spread across  
the country

**OVER 5000+**  
**EMPLOYEES**  
in India

**07**  
**MANUFACTURING**  
facilities

**3**  
**R&D**  
centers

**22**  
**INNOVALS**  
& **3 CENTERS OF**  
**EXCELLENCE**

---

An extensive network of over **870**  
distribution partners and **18000** retailers

# The Global Specialist

A comprehensive solution for your Electrical and Digital Building Infrastructure.

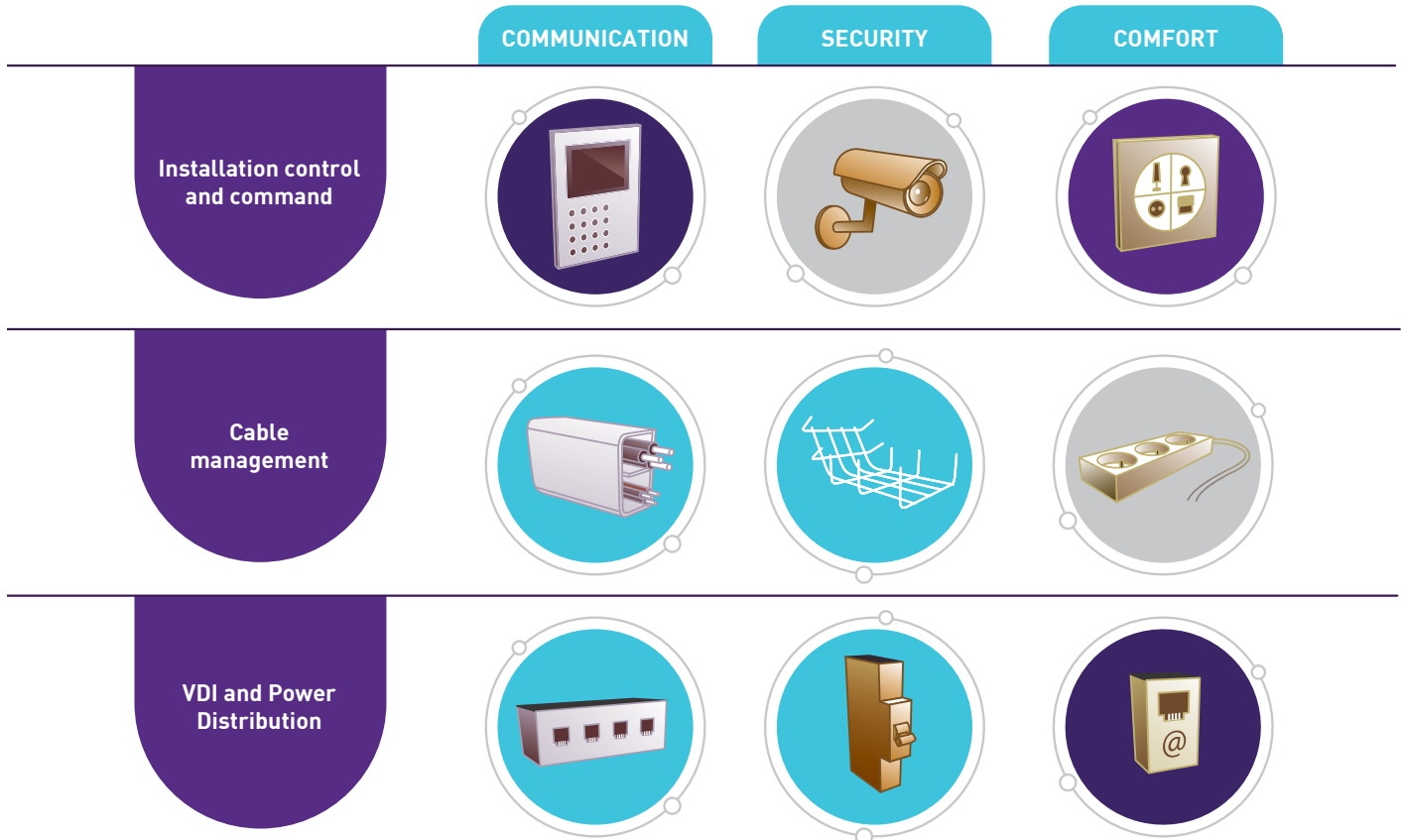

## Global Specialist in Electrical and Digital Building Infrastructure

Legrand is a global specialist in electrical and digital building infrastructures, delivering solutions for homes, data centers, commercial, healthcare, hospitality, and industrial spaces. With nearly 300,000 product references, Legrand holds No. 1 or No. 2 positions in most markets worldwide.

### Continuous Innovation

Over 2200 people work at our engineering and design offices, innovating simple and sustainable solutions.

## Product Design – A lever for differentiation

Design is integral to our overall strategy and lies at the core of everything we do at Legrand. More than aesthetics alone, design is about enhancing the overall customer experience.

# A Landmark Infrastructure Built with Purpose, Rooted in Trust



A massive infrastructure spanning 30000+ sqm, one of the largest factories for Legrand worldwide and India, was inaugurated recently at Nashik, Maharashtra. This factory assumes great significance not just for its investments and massive scale but also for its growth lever placing India at the centre of the Group's ambitions. The factory will soon be a certified green building by IGBC, with a 1 MW roof top solar installation and has been thoughtfully designed, keeping sustainability at the core of its planning.

## PRODUCTS:

Our new Nashik factory is designed to manufacture Bus Bar Trunking Systems (BBTS), Distribution Boards (DBs), Server Racks, Cablofil and Industrial plugs and sockets. The factory is all set to supply products both to the local market and for export, with shipments of BBTs and industrial plug and sockets already reaching international destinations. Plans are in place to expand exports to include DBs and Cablofil products, positioning our India factory as a global supply hub with significant capacity and agility.



# Our Values to Improve Lives

---



## WE SEIZE THE FUTURE

We seize the future by creating lasting, high performance solutions for every kind of building, driven by the vision and talent of our teams



## WE EMBRACE INCLUSION

We embrace inclusion by welcoming diversity among our customers, our people, and our partners, and turning it into a strength and opportunity



## WE MOVE IN SYNC

We grow stronger together - collaborating with people, brands, and partners to shape a connected and future-ready electrical ecosystem



## WE STRIVE FOR SIMPLICITY

We turn challenges into opportunities, creating purposeful innovations that deliver real value across every corner of the electrical sector



## WE ARE DEPENDABLE

We are dependable, guided by reliability and sustainability. For over 150 years, we've built trust through responsible design and ethical relationships with our customers

# Our Commitment to Sustainability

---



At Legrand, sustainability is a key consideration in our product development process.

Every product is crafted with a "**Eco Design**" approach, blending innovation with eco-friendly practices right from the start.

Our Product Environmental Profile (PEP) offers clear and reliable insights into the environmental impact of our products. By supporting green building initiatives and promoting eco-conscious choices, we ensure every product plays a role in building a more sustainable future.



# A Landmark Infrastructure Built with Purpose, Rooted in Trust

---

## Community Initiatives

---

### Legrand Empowering Scholarship

Program Started in 2018, this initiative supports meritorious girl students from lower socio-economic backgrounds in Engineering, Architecture, Science, and Technology. To date, over 700+ students have been enrolled, including 66 differently abled and 25 LGBTQ+ students.

Annually, more than 100 new scholarships are awarded. Additionally, each year over 50 students receive mentorship assistance from Legrand Subject Matter Experts, till date over 150 students have been mentored to be the Future Women Leaders.



### Legrand Telemedicine Center

Through our 3 centres located in Jalgaon, Haridwar, and Rohad, we offer free consultations, tests, and medicines in partnership with Apollo Hospitals. This initiative benefits over 10,000 community members annually and has positively impacted more than 72000 lives to date.

## Center of Excellence - Mathura, Dehradun & Bangalore

The centers at Mathura, ITI Niranjanpur, Dehradun & Bangalore aim to provide advanced training in Electrical & UPS systems. These centers focus on enhancing students' skills and improving their job opportunities. Over 168 ITI students have been trained and over 10 have been placed as service engineers in our company.



## Beach Clean-Up

Legrand adopted four beaches in Mumbai. This initiative aims to remove plastic waste and recycle it. Since September 2023, through the collective efforts of over 13992 volunteers, more than 134676 kg / 134.6 T of plastic has been collected and recycled into ten benches which were further donated to public spaces and schools.



## Water Table Recharge

Legrand has recharged over 100 community borewells in rural and tribal areas using a patented technology that recharges 15–20 lakh litres of groundwater annually, directly providing clean water access to more than 5,000 individuals.



## DRX™ MCCB

| Type and frame size | Rated Current (A) | Poles | Cat.Nos | MRP* ₹ / Unit | Pack |
|---------------------|-------------------|-------|---------|---------------|------|
|---------------------|-------------------|-------|---------|---------------|------|

### DRX MCCBs

|                        |      |        |         |      |      |
|------------------------|------|--------|---------|------|------|
| DRX 100<br>Icu = 10 kA | 63 A | 3 Pole | 0270 39 | 4450 | 1/12 |
|                        | 75 A | 3 Pole | 0270 07 | 4450 | 1/12 |
|                        | 100A | 3 Pole | 0270 08 | 4450 | 1/12 |
|                        | 125A | 3 Pole | 0270 09 | 5840 | 1/12 |
|                        | 63 A | 4 Pole | 0270 29 | 6410 | 1/12 |
|                        | 75 A | 4 Pole | 0270 17 | 6410 | 1/12 |
|                        | 100A | 4 Pole | 0270 18 | 6410 | 1/12 |
|                        | 125A | 4 Pole | 0270 19 | 6890 | 1/12 |

| Description | Cat.Nos | MRP* ₹ / Unit | Pack |
|-------------|---------|---------------|------|
|-------------|---------|---------------|------|

### DIN Rail Adaptor

|         |         |     |   |
|---------|---------|-----|---|
| DRX 100 | 0271 87 | 610 | 1 |
|---------|---------|-----|---|

### Rotary Handles - Direct

|         |         |      |   |
|---------|---------|------|---|
| DRX 100 | 6687 70 | 1530 | 1 |
|---------|---------|------|---|

### Rotary Handles - Vary-Depth

|         |         |      |   |
|---------|---------|------|---|
| DRX 100 | 6687 71 | 2330 | 1 |
|---------|---------|------|---|

### Padlocking Support for Operating Handle

|         |         |      |   |
|---------|---------|------|---|
| DRX 100 | 0271 80 | 2080 | 1 |
|---------|---------|------|---|

### Connection Accessories

|                             |         |     |   |
|-----------------------------|---------|-----|---|
| Set of 2 shields for 3 pole | 0271 81 | 150 | 1 |
|-----------------------------|---------|-----|---|

### Sealable Terminal Shields (Moulded Shrouds)

|                      |         |      |   |
|----------------------|---------|------|---|
| For DRX 100 - 3 pole | 0271 83 | 1990 | 1 |
| For DRX 100 - 4 pole | 0271 84 | 1860 | 1 |

### Cage Terminals

|                      |         |     |   |
|----------------------|---------|-----|---|
| For DRX 100 - 3 pole | 0271 71 | 400 | 1 |
| For DRX 100 - 4 pole | 0271 73 | 380 | 1 |

### Electrical Accessories

|   |         |      |   |
|---|---------|------|---|
| Block with 1 auxiliary (1 AUX)                  | 0271 40 | 1330 | 1 |
| Block with 1 auxiliary (1 AL)                   | 0271 41 | 1330 | 1 |
| Block with 1 auxiliary + 1 alarm (1 AUX + 1 AL) | 0271 42 | 2320 | 1 |

### Current Shunt Coils

|                  |         |      |   |
|------------------|---------|------|---|
| 200/277 V~ and = | 0271 54 | 2880 | 1 |
| 380/480 V~ and = | 0271 55 | 2880 | 1 |

### Undervoltage Release Coils

|            |         |      |   |
|------------|---------|------|---|
| 200/240 V~ | 0271 64 | 3990 | 1 |
| 380/415 V~ | 0271 65 | 3990 | 1 |

### DRX Spreader Links

|                    |         |     |   |
|--------------------|---------|-----|---|
| 3 Links set for TP | 6250 10 | 330 | 1 |
| 4 Links set for FP | 6250 11 | 480 | 1 |

\* MRP - Maximum Retail Price Inclusive of all taxes including GST.



0270 08



0271 83



0271 40

## DRX™ MCCB

| Cat.Nos | Description | No. of modules | MRP* ₹ / Unit | Pack |
|---------|-------------|----------------|---------------|------|
|---------|-------------|----------------|---------------|------|

### Metal One Way Enclosures for MCCB

|         |                           |   |      |   |
|---------|---------------------------|---|------|---|
| 5078 05 | DRX 100 MCCB enclosure-TP | 3 | ■    | 1 |
| 5078 06 | DRX 100 MCCB enclosure-FP | 3 | 3176 | 1 |

# DRX100

The Universal Solution for Residential & Commercial



### Robust Design

- Electrical life - 8000 operations
- Mechanical Life - 25000 operations
- Compliant with standard IES 60947-2

### Complete range of Accessories available

- Direct and Extended Rotary Handles
- Shunt Release, UV Release in multiple voltage range
- Aux, Alarm, Aux + Alarm
- Cage Terminals for Direct Cable Termination
- Spreader Terminals for Enhanced Termination

Bold Cat.Nos are products normally available with Legrand (India) Stockists. Cat.Nos that are not bold - delivery within 4 - 8 weeks from the date of order. Bold packing quantity is our mandatory packing. Orders to be placed by Legrand (India) Stockist in multiples of the same.

## DX<sup>3</sup> MCBs

| Cat.Nos | Nominal Rating | Number of 17.5 mm modules | MRP* ₹ / Unit | Pack |
|---------|----------------|---------------------------|---------------|------|
|---------|----------------|---------------------------|---------------|------|

### MCBs for AC Applications till 63 A

10 kA ISI marked as per IS/IEC 60898-1 2002  
 Integrated label holder  
 Sliding bottom clamp  
 Efficient air channels  
 Color coded On/Off indication on dolly  
 Biconnect lower terminals  
 IP 20 protected terminals  
 Sliding shutters  
 Compatible with signal and control Auxiliaries

#### DC-80 V per pole - 1 kA

#### C Curve

#### Single Pole 240/410 V

|         |     |   |      |          |
|---------|-----|---|------|----------|
| 4085 80 | 0.5 | 1 | 736  | 1/10/120 |
| 4085 81 | 1   | 1 | 736  | 1/10/120 |
| 4085 83 | 2   | 1 | 729  | 1/10/120 |
| 4085 84 | 3   | 1 | 729  | 1/10/120 |
| 4085 85 | 4   | 1 | 729  | 1/10/120 |
| 4085 87 | 6   | 1 | 449  | 1/10/120 |
| 4085 90 | 10  | 1 | 449  | 1/10/120 |
| 4085 92 | 16  | 1 | 449  | 1/10/120 |
| 4085 93 | 20  | 1 | 449  | 1/10/120 |
| 4085 94 | 25  | 1 | 449  | 1/10/120 |
| 4085 95 | 32  | 1 | 449  | 1/10/120 |
| 4085 96 | 40  | 1 | 1026 | 1/10/120 |
| 4085 97 | 50  | 1 | 1026 | 1/10/120 |
| 4085 98 | 63  | 1 | 1026 | 1/10/120 |



4085 90

#### Single Pole + Neutral 240 V

|         |     |   |      |        |
|---------|-----|---|------|--------|
| 4086 02 | 0.5 | 2 | 1925 | 1/5/60 |
| 4086 03 | 1   | 2 | 1925 | 1/5/60 |
| 4086 05 | 2   | 2 | 1925 | 1/5/60 |
| 4086 06 | 3   | 2 | 1925 | 1/5/60 |
| 4086 07 | 4   | 2 | 1925 | 1/5/60 |
| 4086 09 | 6   | 2 | 1362 | 1/5/60 |
| 4086 12 | 10  | 2 | 1362 | 1/5/60 |
| 4086 14 | 16  | 2 | 1362 | 1/5/60 |
| 4086 15 | 20  | 2 | 1362 | 1/5/60 |
| 4086 16 | 25  | 2 | 1362 | 1/5/60 |
| 4086 17 | 32  | 2 | 1362 | 1/5/60 |
| 4086 18 | 40  | 2 | 2203 | 1/5/60 |
| 4086 19 | 50  | 2 | 2203 | 1/5/60 |
| 4086 20 | 63  | 2 | 2203 | 1/5/60 |



4086 14

#### Double Pole 415 V

|         |     |   |      |      |
|---------|-----|---|------|------|
| 4086 21 | 0.5 | 2 | 1999 | 1/40 |
| 4086 22 | 1   | 2 | 1999 | 1/40 |
| 4086 24 | 2   | 2 | 1999 | 1/40 |
| 4086 25 | 3   | 2 | 1999 | 1/40 |
| 4086 26 | 4   | 2 | 1999 | 1/40 |
| 4086 28 | 6   | 2 | 1472 | 1/40 |
| 4086 31 | 10  | 2 | 1472 | 1/40 |
| 4086 33 | 16  | 2 | 1472 | 1/40 |
| 4086 34 | 20  | 2 | 1472 | 1/40 |
| 4086 35 | 25  | 2 | 1472 | 1/40 |
| 4086 36 | 32  | 2 | 1472 | 1/40 |
| 4086 37 | 40  | 2 | 2316 | 1/40 |
| 4086 38 | 50  | 2 | 2316 | 1/40 |
| 4086 39 | 63  | 2 | 2316 | 1/40 |



4086 37

#### Triple Pole 415 V

|         |     |   |      |      |
|---------|-----|---|------|------|
| 4086 43 | 0.5 | 3 | 2944 | 1/32 |
| 4086 44 | 1   | 3 | 2944 | 1/32 |
| 4086 46 | 2   | 3 | 2944 | 1/32 |
| 4086 47 | 3   | 3 | 2944 | 1/32 |
| 4086 48 | 4   | 3 | 2944 | 1/32 |
| 4086 50 | 6   | 3 | 2387 | 1/32 |
| 4086 53 | 10  | 3 | 2387 | 1/32 |
| 4086 55 | 16  | 3 | 2387 | 1/32 |
| 4086 56 | 20  | 3 | 2387 | 1/32 |
| 4086 57 | 25  | 3 | 2387 | 1/32 |
| 4086 58 | 32  | 3 | 2387 | 1/32 |
| 4086 59 | 40  | 3 | 3623 | 1/32 |
| 4086 60 | 50  | 3 | 3623 | 1/32 |
| 4086 61 | 63  | 3 | 3623 | 1/32 |



4086 55

## DX<sup>3</sup> MCBs

| Cat.Nos | Nominal Rating | Number of 17.5 mm modules | MRP* ₹ / Unit | Pack |
|---------|----------------|---------------------------|---------------|------|
|---------|----------------|---------------------------|---------------|------|

### Triple Pole + Neutral 415 V

|         |     |   |      |      |
|---------|-----|---|------|------|
| 4086 65 | 0.5 | 4 | 3735 | 1/32 |
| 4086 66 | 1   | 4 | 3735 | 1/32 |
| 4086 68 | 2   | 4 | 3735 | 1/32 |
| 4086 69 | 3   | 4 | 3735 | 1/32 |
| 4086 70 | 4   | 4 | 3735 | 1/32 |
| 4086 72 | 6   | 4 | 3112 | 1/32 |
| 4086 75 | 10  | 4 | 3112 | 1/32 |
| 4086 77 | 16  | 4 | 3112 | 1/32 |
| 4086 78 | 20  | 4 | 3112 | 1/32 |
| 4086 79 | 25  | 4 | 3112 | 1/32 |
| 4086 80 | 32  | 4 | 3112 | 1/32 |
| 4086 81 | 40  | 4 | 4451 | 1/32 |
| 4086 82 | 50  | 4 | 4451 | 1/32 |
| 4086 83 | 63  | 4 | 4451 | 1/32 |



4086 77

### Four Pole 415 V

|         |     |   |      |      |
|---------|-----|---|------|------|
| 4086 84 | 0.5 | 4 | 3687 | 1/32 |
| 4086 85 | 1   | 4 | 3687 | 1/32 |
| 4086 87 | 2   | 4 | 3687 | 1/32 |
| 4086 88 | 3   | 4 | 3687 | 1/32 |
| 4086 89 | 4   | 4 | 3687 | 1/32 |
| 4086 91 | 6   | 4 | 3243 | 1/32 |
| 4086 94 | 10  | 4 | 3243 | 1/32 |
| 4086 96 | 16  | 4 | 3243 | 1/32 |
| 4086 97 | 20  | 4 | 3243 | 1/32 |
| 4086 98 | 25  | 4 | 3243 | 1/32 |
| 4086 99 | 32  | 4 | 3243 | 1/32 |
| 4087 00 | 40  | 4 | 4614 | 1/32 |
| 4087 01 | 50  | 4 | 4614 | 1/32 |
| 4087 02 | 63  | 4 | 4614 | 1/32 |



4086 94

## DX<sup>3</sup> isolators

| Cat.Nos | Nominal Rating | Number of 17.5 mm modules | MRP* ₹ / Unit | Pack |
|---------|----------------|---------------------------|---------------|------|
|---------|----------------|---------------------------|---------------|------|

### Isolators for AC Applications upto 125 A

ISI marked as per IEC 60947-3  
 Integrated label holder  
 Ergonomic red color dolly  
 Sliding bottom clamp  
 Double break mechanism  
 Improved air channels  
 Color coded On/Off indication on dolly  
 Biconnect lower terminals  
 IP 20 protected terminals  
 Compatible with signal and control Auxiliaries  
 Sliding shutters

#### Double Pole 240 V

|         |     |   |      |        |
|---------|-----|---|------|--------|
| 4065 00 | 32  | 2 | 780  | 1/5/60 |
| 4065 01 | 40  | 2 | 858  | 1/5/60 |
| 4065 02 | 63  | 2 | 1134 | 1/5/60 |
| 4065 04 | 100 | 2 | 1557 | 1/5/60 |
| 4065 05 | 125 | 2 | 1771 | 1/5/60 |



4065 00

#### Triple Pole 415 V

|         |     |   |      |      |
|---------|-----|---|------|------|
| 4065 09 | 32  | 3 | 1405 | 1/40 |
| 4065 10 | 40  | 3 | 1507 | 1/40 |
| 4065 11 | 63  | 3 | 1794 | 1/40 |
| 4065 13 | 100 | 3 | 1980 | 1/40 |
| 4065 14 | 125 | 3 | 2284 | 1/40 |



4065 10

#### Four Pole 415 V

|         |     |   |      |      |
|---------|-----|---|------|------|
| 4065 18 | 32  | 4 | 1541 | 1/32 |
| 4065 19 | 40  | 4 | 1914 | 1/32 |
| 4065 20 | 63  | 4 | 2111 | 1/32 |
| 4065 22 | 100 | 4 | 2551 | 1/32 |
| 4065 23 | 125 | 4 | 2811 | 1/32 |



4065 20

\* MRP - Maximum Retail Price Inclusive of all taxes including GST.

Bold Cat.Nos are products normally available with Legrand (India) Stockists. Cat.Nos that are not bold - delivery within 4 - 8 weeks from the date of order. Bold packing quantity is our mandatory packing. Orders to be placed by Legrand (India) Stockists in multiples of the same.

## DX<sup>3</sup> RCBOs

| Cat.Nos | Nominal Rating | Number of 17.5 mm modules | MRP* ₹ / Unit | Pack |
|---------|----------------|---------------------------|---------------|------|
|---------|----------------|---------------------------|---------------|------|

### RCBOs Assembled for AC Applications upto 63 A

SI marked as per IS 12640-2  
 Integrated label holder  
 Ergonomic design  
 Color coded On/Off indication on dolly  
 Compatible with signal and control Auxiliaries  
 Front face indication for earth leakage fault  
 IP 20 protected terminals  
 35 sq mm terminals  
 Sliding shutters



4113 24

#### Type -AC

Sensitive to residual alternating currents  
 Use : standard applications

#### Double Pole 240 V, AC Type

##### 30 mA

|                |           |          |             |             |
|----------------|-----------|----------|-------------|-------------|
| 4113 22        | 6         | 4        | 5812        | 1/32        |
| 4113 23        | 10        | 4        | 5812        | 1/32        |
| <b>4113 24</b> | <b>16</b> | <b>4</b> | <b>5812</b> | <b>1/32</b> |
| <b>4113 25</b> | <b>25</b> | <b>4</b> | <b>5812</b> | <b>1/32</b> |
| <b>4113 26</b> | <b>32</b> | <b>4</b> | <b>6081</b> | <b>1/32</b> |
| <b>4113 27</b> | <b>40</b> | <b>4</b> | <b>6983</b> | <b>1/32</b> |
| 4113 28        | 63        | 4        | 8508        | 1/32        |

##### 100 mA

|                |           |          |             |             |
|----------------|-----------|----------|-------------|-------------|
| 4113 29        | 6         | 4        | 6991        | 1/32        |
| 4113 30        | 10        | 4        | 6991        | 1/32        |
| 4113 31        | 16        | 4        | 6991        | 1/32        |
| <b>4113 32</b> | <b>25</b> | <b>4</b> | <b>6991</b> | <b>1/32</b> |
| <b>4113 33</b> | <b>32</b> | <b>4</b> | <b>6991</b> | <b>1/32</b> |
| <b>4113 34</b> | <b>40</b> | <b>4</b> | <b>7926</b> | <b>1/32</b> |
| 4113 35        | 63        | 4        | 9147        | 1/32        |

##### 300 mA

|                |           |          |             |             |
|----------------|-----------|----------|-------------|-------------|
| 4113 36        | 16        | 4        | 7213        | 1/32        |
| <b>4113 37</b> | <b>25</b> | <b>4</b> | <b>7213</b> | <b>1/32</b> |
| <b>4113 38</b> | <b>32</b> | <b>4</b> | <b>7213</b> | <b>1/32</b> |
| <b>4113 39</b> | <b>40</b> | <b>4</b> | <b>8133</b> | <b>1/32</b> |
| 4113 40        | 63        | 4        | 9163        | 1/32        |

#### Four Pole 415 V, AC Type

##### 30 mA

|                |           |          |             |             |
|----------------|-----------|----------|-------------|-------------|
| 4113 65        | 16        | 7        | 7781        | 1/16        |
| 4113 66        | 25        | 7        | 7781        | 1/16        |
| <b>4113 67</b> | <b>32</b> | <b>7</b> | <b>7781</b> | <b>1/16</b> |
| <b>4113 68</b> | <b>40</b> | <b>7</b> | <b>8167</b> | <b>1/16</b> |
| <b>4113 69</b> | <b>63</b> | <b>7</b> | <b>9368</b> | <b>1/16</b> |

#### Four Pole 415 V, AC Type

##### 100 mA

|                |           |          |             |             |
|----------------|-----------|----------|-------------|-------------|
| 4113 70        | 16        | 7        | 8770        | 1/16        |
| 4113 71        | 25        | 7        | 8770        | 1/16        |
| <b>4113 72</b> | <b>32</b> | <b>7</b> | <b>8770</b> | <b>1/16</b> |
| <b>4113 73</b> | <b>40</b> | <b>7</b> | <b>9099</b> | <b>1/16</b> |
| 4113 74        | 63        | 7        | 10013       | 1/16        |

#### Four Pole 415 V, AC Type

##### 300 mA

|                |           |          |             |             |
|----------------|-----------|----------|-------------|-------------|
| 4113 75        | 16        | 7        | 9122        | 1/16        |
| 4113 76        | 25        | 7        | 9122        | 1/16        |
| <b>4113 77</b> | <b>32</b> | <b>7</b> | <b>9112</b> | <b>1/16</b> |
| <b>4113 78</b> | <b>40</b> | <b>7</b> | <b>9547</b> | <b>1/16</b> |
| 4113 79        | 63        | 7        | 10189       | 1/16        |



4113 79

\* MRP - Maximum Retail Price Inclusive of all taxes including GST.  
 For terminating aluminium cables in MCBs / Isolators / RCCBs of rating 32 A and above, use of Entry Terminal Cat.No 6034 48 is mandatory.

# RX<sup>3</sup>

## When One is Not Good Enough, 10 Reasons to Switch to RX<sup>3</sup>

The RX<sup>3</sup> range of MCBs, RCCBs, and Isolators is engineered for efficient, reliable, and safe circuit protection. Designed with low energy losses and high durability, it ensures consistent performance across residential installations.



RX<sup>3</sup> MCBs

RX<sup>3</sup> RCCBs

RX<sup>3</sup> Isolators

### Features

- Low watt loss design for improved energy efficiency
- High mechanical endurance up to 20,000 operations
- Supports cable sizes up to 35 mm<sup>2</sup> for flexible installation
- ISI marked and CE certified for quality assurance

### Benefits

- Reduces energy consumption and operating costs
- Enables long service life of up to 13 years with high mechanical endurance
- Enhances installation flexibility while reducing risk of terminal damage
- Ensures safe and reliable performance with certified standards

Scan to know more about the product.



## RX<sup>3</sup> MCBs

| Cat.Nos | Amps. | MRP*<br>₹ / Unit | Pack |
|---------|-------|------------------|------|
|---------|-------|------------------|------|

ISI marked as per IS/IEC 60898-1 (2002)  
 'B' characteristic MCBs with 10 kA breaking capacity  
 Low watt loss  
 35 sq. mm. cage terminals  
 IP20 protected terminals  
 Bi-connect lower terminals  
 No line load bias  
 Suitable for isolation

### Single Pole

|         |      |     |          |
|---------|------|-----|----------|
| 4024 31 | 6 A  | 311 | 1/10/120 |
| 4024 32 | 10 A | 311 | 1/10/120 |
| 4024 33 | 16 A | 311 | 1/10/120 |
| 4024 34 | 20 A | 311 | 1/10/120 |
| 4024 35 | 25 A | 311 | 1/10/120 |
| 4024 36 | 32 A | 311 | 1/10/120 |
| 4024 37 | 40 A | 684 | 1/10/120 |
| 4024 38 | 50 A | 814 | 1/10/120 |
| 4024 39 | 63 A | 814 | 1/10/120 |



4024 32

### Double Pole

|         |      |      |        |
|---------|------|------|--------|
| 4024 40 | 6 A  | 1132 | 1/5/60 |
| 4024 41 | 10 A | 1132 | 1/5/60 |
| 4024 42 | 16 A | 1132 | 1/5/60 |
| 4024 43 | 20 A | 1132 | 1/5/60 |
| 4024 44 | 25 A | 1132 | 1/5/60 |
| 4024 45 | 32 A | 1132 | 1/5/60 |
| 4024 46 | 40 A | 1586 | 1/5/60 |
| 4024 47 | 50 A | 1831 | 1/5/60 |
| 4024 48 | 63 A | 1831 | 1/5/60 |



4024 48

### Triple Pole

|         |      |      |      |
|---------|------|------|------|
| 4024 49 | 6 A  | 1879 | 1/40 |
| 4024 50 | 10 A | 1879 | 1/40 |
| 4024 51 | 16 A | 1879 | 1/40 |
| 4024 52 | 20 A | 1879 | 1/40 |
| 4024 53 | 25 A | 1879 | 1/40 |
| 4024 54 | 32 A | 1879 | 1/40 |
| 4024 55 | 40 A | 2663 | 1/40 |
| 4024 56 | 50 A | 2910 | 1/40 |
| 4024 57 | 63 A | 2910 | 1/40 |



4024 57

### Four Pole

|         |      |      |      |
|---------|------|------|------|
| 4024 58 | 6 A  | 2531 | 1/32 |
| 4024 59 | 10 A | 2531 | 1/32 |
| 4024 60 | 16 A | 2531 | 1/32 |
| 4024 61 | 20 A | 2531 | 1/32 |
| 4024 62 | 25 A | 2531 | 1/32 |
| 4024 63 | 32 A | 2531 | 1/32 |
| 4024 64 | 40 A | 3078 | 1/32 |
| 4024 65 | 50 A | 3506 | 1/32 |
| 4024 66 | 63 A | 3506 | 1/32 |



4024 66

## RX<sup>3</sup> Isolators

Conforms to IS 13947-3 (IEC 60947-3)  
 35 sq. mm cage terminals with safety shutters  
 Bi-connect lower terminals

### Double Pole

|         |      |      |        |
|---------|------|------|--------|
| 4020 08 | 40 A | 764  | 1/5/60 |
| 4020 09 | 63 A | 988  | 1/5/60 |
| 4020 10 | 80 A | 1291 | 1/5/60 |



4020 08

### Triple Pole

|         |      |      |      |
|---------|------|------|------|
| 4020 14 | 40 A | 1480 | 1/40 |
| 4020 15 | 63 A | 1638 | 1/40 |
| 4020 16 | 80 A | 2047 | 1/40 |



4020 14

### Four Pole

|         |      |      |      |
|---------|------|------|------|
| 4020 20 | 40 A | 1747 | 1/32 |
| 4020 21 | 63 A | 1857 | 1/32 |
| 4020 22 | 80 A | 2330 | 1/32 |



4020 20

\* MRP - Maximum Retail Price Inclusive of all taxes including GST.  
 For terminating aluminium cables in MCBs / Isolators / RCCBs of rating 32 A and above, use of Entry Terminal Cat.No 6034 48 is mandatory.

## RX<sup>3</sup> RCCBs

| Cat.Nos | Amps. | MRP*<br>₹ / Unit | Pack |
|---------|-------|------------------|------|
|---------|-------|------------------|------|

As per IS 12640 - 2008  
 Bi-connect lower terminal

### Double Pole - Sensitivity 30 mA

|         |      |      |        |
|---------|------|------|--------|
| 4024 88 | 25 A | 3845 | 1/5/60 |
| 4024 89 | 40 A | 4339 | 1/5/60 |
| 4024 90 | 63 A | 5277 | 1/5/60 |



4024 93

### Double Pole - Sensitivity 100 mA

|         |      |      |        |
|---------|------|------|--------|
| 4024 92 | 25 A | 4059 | 1/5/60 |
| 4024 93 | 40 A | 4651 | 1/5/60 |
| 4024 94 | 63 A | 5521 | 1/5/60 |

### Four Pole - Sensitivity 30 mA

|         |      |      |      |
|---------|------|------|------|
| 4025 19 | 25 A | 4943 | 1/32 |
| 4025 20 | 40 A | 5074 | 1/32 |
| 4025 21 | 63 A | 5856 | 1/32 |



4025 25

### Four Pole - Sensitivity 100 mA

|         |      |      |      |
|---------|------|------|------|
| 4025 23 | 25 A | 5263 | 1/32 |
| 4025 24 | 40 A | 5390 | 1/32 |
| 4025 25 | 63 A | 6279 | 1/32 |

## RX<sup>3</sup> Accessory

| Cat.Nos | Description | MRP*<br>₹ / Unit | Pack |
|---------|-------------|------------------|------|
|---------|-------------|------------------|------|

### Entry terminal

|         |  |     |   |
|---------|--|-----|---|
| 6034 48 | 50 mm <sup>2</sup> Entry Terminal for RCCB | 171 | 1 |
|---------|--|-----|---|



6034 48

### 'B' characteristic MCB tripping curve

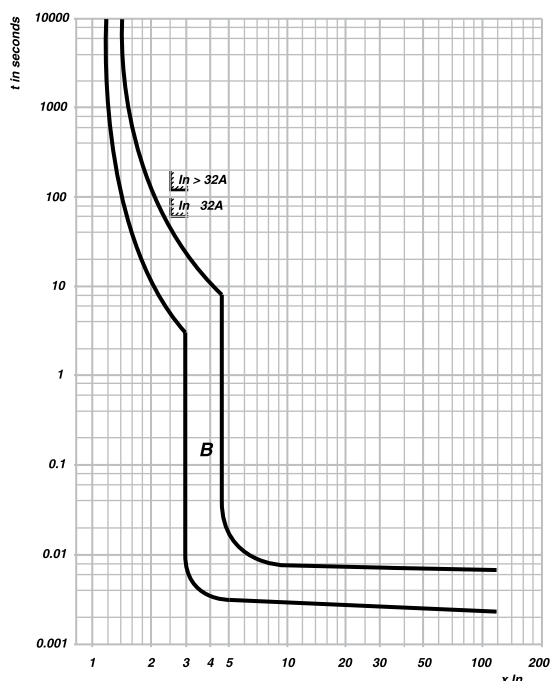

Bold Cat.Nos are products normally available with Legrand (India) Stockists.  
 Cat.Nos that are not bold - delivery within 4 - 8 weeks from the date of order.  
 Bold packing quantity is our mandatory packing. Orders to be placed by Legrand (India) Stockists in multiples of the same.

# ACCL

Automatic Changeover with Current Limiter

## Seamless Power Switching for Smart Electrical Systems



ACCL ensures uninterrupted power by automatically switching between mains and generator supply. Designed with intelligent control and built-in current limiting, it protects the generator from overload while maintaining reliable power continuity for residential and commercial installations.

### Features

- Intelligent microcontroller-based design
- Built-in current limiter to prevent generator overload
- Break-before-make switching mechanism with neutral isolation
- LED status indicators with buzzer alerts and manual reset function

### Benefits

- Ensures continuous power supply during mains failure
- Protects generator systems from overload damage
- Improves safety through controlled and reliable power transfer
- Simplifies monitoring with clear visual and audible status alerts

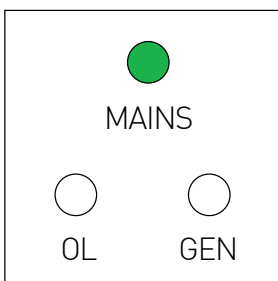

Mains ON

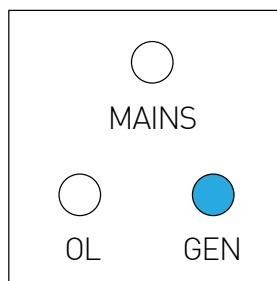

Genset ON

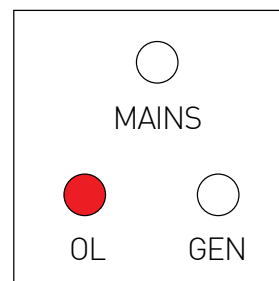

Overload



Scan to know more about the product.

## Automatic Changeover with Current Limiter (ACCL)

| Cat.Nos | Description | MRP*<br>₹ /<br>Unit | Pack |
|---------|-------------|---------------------|------|
|---------|-------------|---------------------|------|

Intelligent micro controller based design

Automatic source change over between Mains &

Generator supply

Break before make change over system

Buzzer and Led Indication of status

Current limitation prevents overloading of the generator

|         |            |      |      |
|---------|------------|------|------|
| 4053 00 | SPN 30/3A  | 3220 | 1/15 |
| 4053 01 | SPN 30/4A  | 3220 | 1/15 |
| 4053 02 | SPN 30/5A  | 3220 | 1/15 |
| 4053 03 | SPN 30/6A  | 3220 | 1/15 |
| 4053 04 | SPN 30/9A  | 3220 | 1/15 |
| 4053 05 | SPN 30/12A | 3220 | 1/15 |
| 4053 06 | SPN 30/15A | 3220 | 1/15 |
| 4053 07 | SPN 30/20A | 3220 | 1/15 |
| 4053 08 | SPN 30/30A | 3220 | 1/15 |

\* MRP - Maximum Retail Price Inclusive of all taxes including GST.

Bold Cat.Nos are products normally available with Legrand (India) Stockists. Cat.Nos that are not bold - delivery within 4 - 8 weeks from the date of order. Bold packing quantity is our mandatory packing. Orders to be placed by Legrand (India) Stockists in multiples of the same.

# Ekinox

Reinvent The New

Safety Styled for  
Modern Spaces



## MAKE A **SECOND** GLANCE

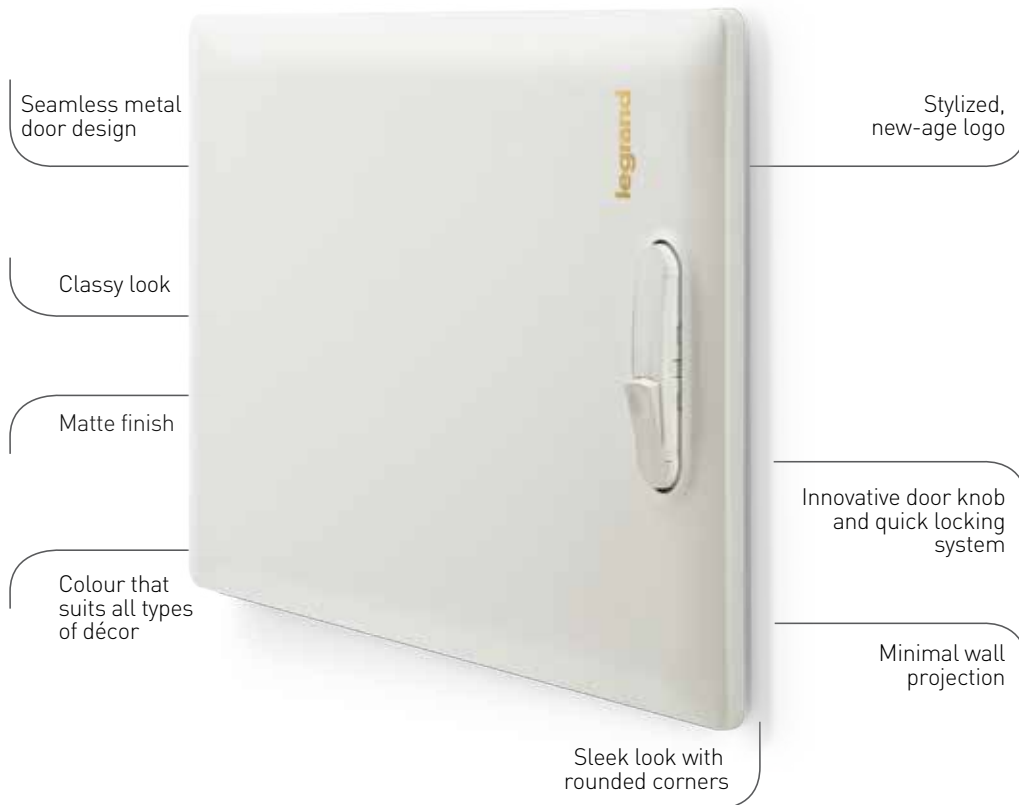

Scan to know more about the product.



## Features and benefits

Maximum reliability & excellent safety-  
Designed in accordance with IEC 61439-3



Integrated earthing system in order to avert risky contact



Completely insulated bus bars guarantee safety from severe shocks

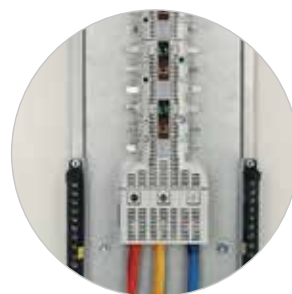

Shrouded neutral bars and insulated din rail for complete isolation



Reversible door can be easily removed



Normal lock convertible to key lock, so that it isn't tampered with



Colour-coded neutral bars for easy identification



Plastic plugs for mounting holes

## Ekinox<sup>3</sup> SPN DB's

For DX<sup>3</sup> MCB, Isolator, RCCB and RCBO

| Cat.Nos | Number of ways | No. of modules | MRP*<br>₹ / Unit | Pack |
|---------|----------------|----------------|------------------|------|
|---------|----------------|----------------|------------------|------|

- As per IEC 61439-3
- Suitable for Flush Mounting and Surface Mounting
- With 100 A Copper Busbar
- With Neutral bar, Earthbar and Cable ties for Cable management
- Fully shrouded Neutral bars
- Prefitted masking sheet
- Reversible Door for IP 43 & IP 54 DB's

### IP 30 - \*IK 08

|         |        |    |      |   |
|---------|--------|----|------|---|
| 5076 00 | 4 way  | 4  | 2128 | 1 |
| 5076 01 | 8 way  | 8  | 2581 | 1 |
| 5076 02 | 12 way | 12 | 3050 | 1 |
| 5076 03 | 16 way | 16 | 3726 | 1 |
| 5076 04 | 18 way | 18 | 4334 | 1 |
| 5076 05 | 20 way | 20 | 4434 | 1 |



5076 05



5076 12

### IP 43 - \*IK 09 with Metal Door

|         |        |    |      |   |
|---------|--------|----|------|---|
| 5076 10 | 4 way  | 4  | 2788 | 1 |
| 5076 11 | 8 way  | 8  | 3597 | 1 |
| 5076 12 | 12 way | 12 | 4322 | 1 |
| 5076 13 | 16 way | 16 | 5415 | 1 |
| 5076 14 | 18 way | 18 | 5690 | 1 |
| 5076 15 | 20 way | 20 | 6573 | 1 |

### IP 43 - \*IK 09 with Acrylic Door

|         |        |    |      |   |
|---------|--------|----|------|---|
| 5076 20 | 4 way  | 4  | 3726 | 1 |
| 5076 21 | 8 way  | 8  | 4316 | 1 |
| 5076 22 | 12 way | 12 | 5245 | 1 |
| 5076 23 | 16 way | 16 | 6514 | 1 |
| 5076 24 | 18 way | 18 | 6815 | 1 |
| 5076 25 | 20 way | 20 | 7216 | 1 |



5076 42

### IP 54 - \*IK 09

|         |        |    |       |   |
|---------|--------|----|-------|---|
| 5076 40 | 4 way  | 4  | 9579  | 1 |
| 5076 41 | 8 way  | 8  | 11386 | 1 |
| 5076 42 | 12 way | 12 | 13080 | 1 |
| 5076 43 | 16 way | 16 | 14525 | 1 |
| 5076 44 | 18 way | 18 | 14684 | 1 |
| 5076 45 | 20 way | 20 | 15958 | 1 |

## Ekinox<sup>3</sup> ETPN DB's

For DX<sup>3</sup> MCB, Isolator, RCCB and RCBO

- As per IEC 61439-3
- Suitable for Flush Mounting and Surface Mounting
- With 100 A Copper Busbar for each phase
- With Neutral bar, Earthbar and Cable ties for Cable management
- Fully insulated busbar & shrouded Neutral bars
- Improved Pan assembly for ease of installation
- Prefitted masking sheet
- Reversible Door for IP 43 & IP 54 DB's
- With provision for FP MCB/Isolator/RCCB/RCBO as incomer and SP MCB's as outgoing
- Supplied with wireset
- Can be converted to PPI DB at site using conversion kit

### IP 30 - \*IK 08

|         |        |      |       |   |
|---------|--------|------|-------|---|
| 5076 60 | 4 way  | 8+12 | 6131  | 1 |
| 5076 61 | 6 way  | 8+18 | 7605  | 1 |
| 5076 62 | 8 way  | 8+24 | 8981  | 1 |
| 5076 63 | 12 way | 8+36 | 12805 | 1 |
| 5076 64 | 16 way | 8+48 | 15596 | 1 |
| 5076 66 | 20 way | 8+60 | 21766 | 1 |



5077 01



5077 11

\* MRP - Maximum Retail Price Inclusive of all taxes including GST.

## Ekinox<sup>3</sup> ETPN DB's

For DX<sup>3</sup> MCB, Isolator, RCCB and RCBO

| Cat.Nos | Number of ways | No. of modules | MRP*<br>₹ / Unit | Pack |
|---------|----------------|----------------|------------------|------|
|---------|----------------|----------------|------------------|------|

### IP 43 - \*IK 09 with metal door

|         |        |      |       |   |
|---------|--------|------|-------|---|
| 5076 70 | 4 way  | 8+12 | 7335  | 1 |
| 5076 71 | 6 way  | 8+18 | 8841  | 1 |
| 5076 72 | 8 way  | 8+24 | 10593 | 1 |
| 5076 73 | 12 way | 8+36 | 15709 | 1 |
| 5076 74 | 16 way | 8+48 | 19664 | 1 |
| 5076 76 | 20 way | 8+60 | 27398 | 1 |

### IP 43 - \*IK 09 with acrylic door

|         |        |      |       |   |
|---------|--------|------|-------|---|
| 5076 80 | 4 way  | 8+12 | 9237  | 1 |
| 5076 81 | 6 way  | 8+18 | 11292 | 1 |
| 5076 82 | 8 way  | 8+24 | 13289 | 1 |
| 5076 83 | 12 way | 8+36 | 20584 | 1 |
| 5076 84 | 16 way | 8+48 | 24787 | 1 |
| 5076 86 | 20 way | 8+60 | 33509 | 1 |

### IP 54 - \*IK 09

|         |        |      |       |   |
|---------|--------|------|-------|---|
| 5076 90 | 4 way  | 8+12 | 22966 | 1 |
| 5076 91 | 6 way  | 8+18 | 27636 | 1 |
| 5076 92 | 8 way  | 8+24 | 30224 | 1 |
| 5076 93 | 12 way | 8+36 | 43009 | 1 |
| 5076 94 | 16 way | 8+48 | 51114 | 1 |
| 5076 96 | 20 way | 8+60 | 60809 | 1 |

## Ekinox<sup>3</sup> Flexy DB

For DX<sup>3</sup> DIN modular products

| Cat.Nos | Number of row | No. of modules | MRP*<br>₹ / Unit | Pack |
|---------|---------------|----------------|------------------|------|
|---------|---------------|----------------|------------------|------|

- As per IEC 61439-3
- Suitable for Flush Mounting and Surface Mounting
- Completely flexible to organise the distribution as per site requirements
- Busbars to be selected as per distribution requirements
- With Neutral and Earth bars
- Fully shrouded Neutral bars
- Improved Pan assembly for ease of installation
- Prefitted masking sheet
- Reversible door for IP 43

### IP 30 - \*IK 08

|         |               |    |       |   |
|---------|---------------|----|-------|---|
| 5077 01 | 2 row of 14 M | 28 | 7433  | 1 |
| 5077 02 | 3 row of 14 M | 42 | 9304  | 1 |
| 5077 03 | 4 row of 14 M | 56 | 10317 | 1 |

### IP 43 - \*IK 09 with metal door

|         |  |    |       |   |
|---------|--|----|-------|---|
| 5077 05 | 2 row of 14 M  | 28 | 9362  | 1 |
| 5077 06 | 3 row of 4 M   | 42 | 11191 | 1 |
| 5077 07 | 4 row of 14 M  | 56 | 12133 | 1 |
| 5077 14 | 4 row of 8 M   | 32 | 10351 | 1 |
| 5077 15 | 4 row of 10 M  | 40 | 10835 | 1 |
| 5077 12 | 3 row of 14 M<br>MCCB for DPX <sup>3</sup><br>160 MCCB | 42 | 12881 | 1 |

### IP 43 - \*IK 09 with acrylic door

|         |  |    |       |   |
|---------|--|----|-------|---|
| 5077 09 | 2 row of 14 M  | 28 | 9874  | 1 |
| 5077 10 | 3 row of 14 M  | 42 | 12135 | 1 |
| 5077 11 | 4 row of 14 M  | 56 | 13749 | 1 |
| 5077 13 | 3 row of 14 M<br>MCCB for DPX <sup>3</sup><br>160 MCCB | 42 | 14330 | 1 |

Bold Cat.Nos are products normally available with Legrand (India) Stockists. Cat.Nos that are not bold - delivery within 4 - 8 weeks from the date of order. Bold packing quantity is our mandatory packing. Orders to be placed by Legrand (India) Stockist in multiples of the same.

## Ekinox<sup>3</sup> TPN DB-VTPN DB's

For DX<sup>3</sup> MCB, Isolator, RCCB and RCBO

| Cat.Nos | Number of ways | No. of modules | MRP*<br>₹ / Unit | Pack |
|---------|----------------|----------------|------------------|------|
|---------|----------------|----------------|------------------|------|

- As per IEC 61439-3
- Suitable for Flush Mounting and Surface Mounting
- With 100 A Copper Busbar for each phase
- With 2 Neutral bar, 2 Earthbar and Cable ties for Cable management
- Fully insulated busbar & shrouded Neutral bars
- Improved Pan assembly for ease of installation
- Prefitted masking sheet
- Reversible Door for IP 43 & IP 54 DB's
- With provision for FP MCB/Isolator/RCCB/RCBO as incomer and SP/TP MCB's as outgoing



5077 20

### IP 30 - #IK 08

|         |        |      |       |   |
|---------|--------|------|-------|---|
| 5077 20 | 4 way  | 8+12 | 16452 | 1 |
| 5077 21 | 6 way  | 8+18 | 18055 | 1 |
| 5077 22 | 8 way  | 8+24 | 20084 | 1 |
| 5077 23 | 12 way | 8+36 | 28998 | 1 |

### IP 43 - #IK 09 with metal door

|         |        |      |       |   |
|---------|--------|------|-------|---|
| 5077 25 | 4 way  | 8+12 | 17350 | 1 |
| 5077 26 | 6 way  | 8+18 | 19215 | 1 |
| 5077 27 | 8 way  | 8+24 | 22365 | 1 |
| 5077 28 | 12 way | 8+36 | 30090 | 1 |

### IP 43 - #IK 09 with acrylic door

|         |        |      |       |   |
|---------|--------|------|-------|---|
| 5077 30 | 4 way  | 8+12 | 22512 | 1 |
| 5077 31 | 6 way  | 8+18 | 24770 | 1 |
| 5077 32 | 8 way  | 8+24 | 28964 | 1 |
| 5077 33 | 12 way | 8+36 | 38641 | 1 |



5077 31

### IP 54 - #IK 09

|         |        |      |       |   |
|---------|--------|------|-------|---|
| 5077 35 | 4 way  | 8+12 | 36085 | 1 |
| 5077 36 | 6 way  | 8+18 | 39236 | 1 |
| 5077 37 | 8 way  | 8+24 | 43403 | 1 |
| 5077 38 | 12 way | 8+36 | 56188 | 1 |

## Ekinox<sup>3</sup> TPN DB-VTPN

DPX<sup>3</sup> 160 MCCB DB's

- As per IEC 61439-3
- Suitable for Flush Mounting and Surface Mounting
- With 250 A Copper Busbar for each phase
- With 2 Neutral bar, 2 Earthbar and Cable ties for Cable management
- Fully insulated busbar & shrouded Neutral bars
- Improved Pan assembly for ease of installation
- Prefitted masking sheet
- Reversible Door for IP 43 & IP 54 DB's
- With provision for DPX<sup>3</sup> 160 MCCB as incomer and SP/TP MCB's as outgoing

### IP 30 - #IK 08

|         |        |                         |       |   |
|---------|--------|-------------------------|-------|---|
| 5077 40 | 4 way  | DPX <sup>3</sup> 160+12 | 18457 | 1 |
| 5077 41 | 6 way  | DPX <sup>3</sup> 160+18 | 19741 | 1 |
| 5077 42 | 8 way  | DPX <sup>3</sup> 160+24 | 21497 | 1 |
| 5077 43 | 12 way | DPX <sup>3</sup> 160+36 | 32562 | 1 |

### IP 43 - #IK 09 with metal door

|         |        |                         |       |   |
|---------|--------|-------------------------|-------|---|
| 5077 45 | 4 way  | DPX <sup>3</sup> 160+12 | 21185 | 1 |
| 5077 46 | 6 way  | DPX <sup>3</sup> 160+18 | 24044 | 1 |
| 5077 47 | 8 way  | DPX <sup>3</sup> 160+24 | 26489 | 1 |
| 5077 48 | 12 way | DPX <sup>3</sup> 160+36 | 36113 | 1 |



5077 53



5077 55



5076 61



5077 81N

## Ekinox<sup>3</sup> TPN DB-VTPN

DPX<sup>3</sup> 160 MCCB DB's

| Cat.Nos | Number of ways | No. of modules | MRP*<br>₹ / Unit | Pack |
|---------|----------------|----------------|------------------|------|
|---------|----------------|----------------|------------------|------|

### IP 54 - #IK 09

|         |        |                         |       |   |
|---------|--------|-------------------------|-------|---|
| 5077 50 | 4 way  | DPX <sup>3</sup> 160+12 | 42348 | 1 |
| 5077 51 | 6 way  | DPX <sup>3</sup> 160+18 | 48219 | 1 |
| 5077 52 | 8 way  | DPX <sup>3</sup> 160+24 | 52387 | 1 |
| 5077 53 | 12 way | DPX <sup>3</sup> 160+36 | 69016 | 1 |

## Ekinox<sup>3</sup> TPN DB-VTPN

DPX<sup>3</sup> 250 MCCB DB's

- As per IEC 61439-3
- Suitable for Flush Mounting and Surface Mounting
- With 250 A Copper Busbar for each phase
- With 2 Neutral bar, 2 Earthbar and Cable ties for Cable management
- Fully insulated busbar & shrouded Neutral bars
- Improved Pan assembly for ease of installation
- Prefitted masking sheet
- Reversible Door for IP 43 & IP 54 DB's
- With provision for DPX<sup>3</sup> 250 MCCB as incomer and SP/TP MCB's as outgoing

### IP 30 - #IK 08

|         |        |                         |       |   |
|---------|--------|-------------------------|-------|---|
| 5077 55 | 4 way  | DPX <sup>3</sup> 250+12 | 29552 | 1 |
| 5077 56 | 8 way  | DPX <sup>3</sup> 250+24 | 31416 | 1 |
| 5077 57 | 12 way | DPX <sup>3</sup> 250+36 | 34675 | 1 |

### IP 43 - #IK 09 with metal door

|         |        |                         |       |   |
|---------|--------|-------------------------|-------|---|
| 5077 58 | 4 way  | DPX <sup>3</sup> 250+12 | 32495 | 1 |
| 5077 59 | 8 way  | DPX <sup>3</sup> 250+24 | 34268 | 1 |
| 5077 60 | 12 way | DPX <sup>3</sup> 250+36 | 38723 | 1 |

### IP 54 - #IK 09

|         |        |                         |       |   |
|---------|--------|-------------------------|-------|---|
| 5077 61 | 4 way  | DPX <sup>3</sup> 250+12 | 49957 | 1 |
| 5077 62 | 8 way  | DPX <sup>3</sup> 250+24 | 57090 | 1 |
| 5077 63 | 12 way | DPX <sup>3</sup> 250+36 | 66715 | 1 |

## NEO DB

### Phase Selector Neo DB

- As per IEC 61439-3
- Compact and sleek design
- IP 43 protection & IK 09
- Integrated LED indication in the selector switches
- With 100A copper busbar for each phase
- Fully insulated busbar & shrouded Neutral bars

|          |        |      |       |   |
|----------|--------|------|-------|---|
| 5077 80N | 4 way  | 8+12 | 19049 | 1 |
| 5077 81N | 6 way  | 8+18 | 19357 | 1 |
| 5077 82N | 8 way  | 8+24 | 20737 | 1 |
| 5077 83N | 12 way | 8+36 | 23354 | 1 |

\* MRP - Maximum Retail Price Inclusive of all taxes including GST.

Bold Cat.Nos are products normally available with Legrand (India) Stockists. Cat.Nos that are not bold - delivery within 4 - 8 weeks from the date of order. Bold packing quantity is our mandatory packing. Orders to be placed by Legrand (India) Stockist in multiples of the same.

## NEO DB

| Cat.Nos | Description | MRP*<br>₹ / Unit | Pack |
|---------|-------------|------------------|------|
|---------|-------------|------------------|------|

### 8 Segment Neo DB

#### IP 42 - #IK 09 with Metal Door

- As per IEC 61439-3
- DB with phase segmentation and separation between Incomer and Outgoings
- Sturdy & Robust design
- With 100A copper busbar for each phase
- Colour coded Neutral Bars
- Easy to Install : Detachable frame
- 8 compartments
- More number of knockouts
- IP42 & IK09
- Supplied with wire-set
- With provision for DPX<sup>3</sup> 160 MCCB as incomer DP MCB/Isolator/RCCB/RCBO as sub incomers and SP MCB's as outgoing



5078 86N

|          |                   |       |   |
|----------|-------------------|-------|---|
| 5078 85N | 4W 8/7S IP42 Neo  | 14681 | 1 |
| 5078 86N | 6W 8/7S IP42 Neo  | 16447 | 1 |
| 5078 87N | 8W 8/7S IP42 Neo  | 18423 | 1 |
| 5078 88N | 12W 8/7S IP42 Neo | 22936 | 1 |

#### IP 42- #IK09 suitable for 160A DPX<sup>3</sup> MCCB as incomer

|          |                             |       |   |
|----------|-----------------------------|-------|---|
| 5078 95N | 4W 8/7S 160A MCCB IP42 Neo  | 20380 | 1 |
| 5078 96N | 6W 8/7S 160A MCCB IP42 Neo  | 23313 | 1 |
| 5078 97N | 8W 8/7S 160A MCCB IP42 Neo  | 26942 | 1 |
| 5078 98N | 12W 8/7S 160A MCCB IP42 Neo | 30418 | 1 |

## Ekinox<sup>3</sup> Metal Enclosures

### For DX<sup>3</sup> MCB, RCCB, RCBO and DPX<sup>3</sup> MCCB's

- As per IEC 61439-3
- Suitable for Flush Mounting and Surface Mounting
- Suitable for protection of appliances like AC/Geyser etc
- Supplied with Neutral Links
- With provision for mounting modular devices

#### #IK 08

|         |               |   |      |   |
|---------|---------------|---|------|---|
| 5078 10 | 10 A SP, 2P+E | 1 | 2771 | 1 |
| 5078 11 | 20 A SP, 2P+E | 1 | 2985 | 1 |
| 5078 14 | 20 A DP, 2P+E | 2 | 3243 | 1 |
| 5078 17 | 20 A TP, 3P+E | 3 | 5494 | 1 |

\* MRP - Maximum Retail Price Inclusive of all taxes including GST.

## Ekinox<sup>3</sup> Metal Enclosures

| Cat.Nos | Number of ways | No. of modules | MRP*<br>₹ / Unit | Pack |
|---------|----------------|----------------|------------------|------|
|---------|----------------|----------------|------------------|------|

|         |               |   |      |   |
|---------|---------------|---|------|---|
| 5078 18 | 32 A TP, 3P+E | 3 | 6518 | 1 |
| 5078 20 | 20 A DP       | 4 | 3137 | 1 |
| 5078 21 | RCBO, 2P+E    | 8 | 5485 | 1 |
| 5078 22 | 20 A FP       | 8 | 6466 | 1 |
|         | RCBO, 2P+E    |   |      |   |
|         | 32 A FP       | 8 | 6466 | 1 |
|         | RCBO, 3P+E    |   |      |   |



5078 22



5078 60



5078 62



5078 64



5077 91



5077 93

## Ekinox<sup>3</sup> Metal Enclosures

### For DX<sup>3</sup> MCB, RCCB, RCBO and DPX<sup>3</sup> MCCB's

- As per IEC 61439-3
- Suitable for Flush Mounting and Surface Mounting
- Supplied with Neutral Links
- With provision for mounting modular devices

#### #IK 08

|         |              |   |       |   |
|---------|--------------|---|-------|---|
| 5078 60 | 16 A 2P+E-DP | 2 | 4525  | 1 |
| 5078 63 | 32 A 2P+E-DP | 2 | 4891  | 1 |
| 5078 61 | 32 A 3P+E-FP | 8 | 8188  | 1 |
| 5078 62 | 32 A         | 8 | 8283  | 1 |
|         | 3P+N+E-FP    |   |       |   |
| 5078 64 | 63 A         | 8 | 20618 | 1 |
|         | 3P+N+E-FP    |   |       |   |

- As per IEC 61439-3

- For independent mounting of DX<sup>3</sup> MCB, RCCB, RCBO, DPX<sup>3</sup> 160, DPX<sup>3</sup> 250, DPX<sup>3</sup> 630 & DRX MCCB's

- #IK 08

#### #IK 08

|         |                   |   |      |   |
|---------|-------------------|---|------|---|
| 5077 90 | SP enclosure      | 1 | 761  | 1 |
| 5077 91 | DP enclosure      | 2 | 1097 | 1 |
| 5077 92 | TP enclosure      | 3 | 1097 | 1 |
| 5077 93 | FP enclosure      | 4 | 1097 | 1 |
| 5077 94 | FP RCBO enclosure | 8 | 1835 | 1 |

### Metal One Way Enclosures for MCCB

|         |                                     |     |       |   |
|---------|-------------------------------------|-----|-------|---|
| 5078 01 | DPX <sup>3</sup> 160 MCCB enclosure | 3&4 | 6242  | 1 |
| 5078 02 | DPX <sup>3</sup> 250 MCCB enclosure | 3&4 | 10976 | 1 |
| 5078 04 | DPX <sup>3</sup> 630 MCCB enclosure | 3&4 | 17050 | 1 |
| 5078 05 | DRX 100 MCCB enclosure-TP           | 3   | 3370  | 1 |
| 5078 06 | DRX 100 MCCB enclosure-FP           | 4   | 3176  | 1 |

Bold Cat.Nos are products normally available with Legrand (India) Stockists. Cat.Nos that are not bold - delivery within 4 - 8 weeks from the date of order. Bold packing quantity is our mandatory packing. Orders to be placed by Legrand (India) Stockist in multiples of the same.

## Ekinox<sup>3</sup> Metal Enclosures

| Cat.Nos | Description | MRP*<br>₹ /<br>Unit | Pack |
|---------|-------------|---------------------|------|
|---------|-------------|---------------------|------|

### Ekinox<sup>3</sup> Cable End Box

- Useful for keeping extra cables
- Possible to mount on the top or bottom of the DB
- Provision for mounting terminal blocks
- Can be used as a terminal box adaptor also

#### For IP 30 DB's

|         |                                  |      |   |
|---------|----------------------------------|------|---|
| 5079 10 | For SPN 4 W IP30                 | 1111 | 1 |
| 5079 12 | For SPN 8 W IP30                 | 1288 | 1 |
| 5079 14 | For SPN 12 W/<br>VTPN/Flexy      | 1456 | 1 |
| 5079 16 | For SPN 16 W/<br>ETPN 6 way DB   | 2045 | 1 |
| 5079 25 | For ETPN 8 way DB                | 3673 | 1 |
| 5079 27 | For ETPN 12 way DB               | 4850 | 1 |
| 5079 29 | For ETPN 16 way DB               | 4850 | 1 |
| 5079 31 | For ETPN 18 way DB               | 5021 | 1 |
| 5079 33 | For ETPN 20 way DB               | 5198 | 1 |
| 5079 35 | For ETPN 4 way<br>VTPN/FLEXY MCB | 1442 | 1 |
| 5079 37 | For all VTPN MCCB DBS            | 5313 | 1 |

#### For IP 43 DB's

|         |                                  |      |   |
|---------|----------------------------------|------|---|
| 5079 11 | For SPN 4 way DB                 | 1272 | 1 |
| 5079 13 | For SPN 8 way DB                 | 1553 | 1 |
| 5079 15 | For SPN 12 way/<br>VTPN/Flexy DB | 1741 | 1 |

#### For IP 43 DB's

|         |                                   |      |   |
|---------|-----------------------------------|------|---|
| 5079 17 | For SPN 16 way/<br>ETPN 6 way DB  | 2473 | 1 |
| 5079 18 | For SPN 18 way DB                 | 2475 | 1 |
| 5079 19 | For SPN 20/ETPN<br>8 way DB       | 2585 | 1 |
| 5079 28 | For ETPN 12 way DB                | 5550 | 1 |
| 5079 30 | For ETPN 16 way DB                | 5656 | 1 |
| 5079 32 | For ETPN 18 way DB                | 5766 | 1 |
| 5079 34 | For ETPN 20 way DB                | 6100 | 1 |
| 5079 36 | For all ETPN<br>4W/VTPN/Flexy MCB | 1741 | 1 |

\* MRP - Maximum Retail Price Inclusive of all taxes including GST

▼ Compatible with Ekinox<sup>3</sup> and NEO DB.

## Ekinox<sup>3</sup> Metal Enclosures

| Cat.Nos | Description | MRP*<br>₹ /<br>Unit | Pack |
|---------|-------------|---------------------|------|
|---------|-------------|---------------------|------|

### For IP 43 DB's

|          |                         |      |   |
|----------|-------------------------|------|---|
| 5079 38  | For all VTPN MCCB DBs   | 6182 | 1 |
| 5079 00▼ | For 7 segment 4 way DB  | 5055 | 1 |
| 5079 01▼ | For 7 segment 6 way DB  | 5548 | 1 |
| 5079 02▼ | For 7 segment 8 way DB  | 6187 | 1 |
| 5079 03▼ | For 7 segment 12 way DB | 6994 | 1 |

## Ekinox<sup>3</sup> DBs

### Meter Box

- Suitable for Mounting DX<sup>3</sup> Metering products
- Possible to mount on the top or bottom of the DB
- Provision for mounting Ammeter/Voltmeter/ASS/VSS
- #IK09

### Provision for Mounting Meters

|         |                              |      |   |
|---------|------------------------------|------|---|
| 5079 40 | For VTPN MCB<br>INCOM IP 30  | 6847 | 1 |
| 5079 41 | For VTPN MCB<br>INCOM IP 43  | 8402 | 1 |
| 5079 42 | For VTPN MCCB<br>INCOM IP 30 | 7615 | 1 |
| 5079 43 | For VTPN MCCB<br>INCOM IP 43 | 9697 | 1 |

### Per Phase Isolation Kit

|         |  |      |   |
|---------|--|------|---|
| 5079 44 | PPI conversion kit for<br>ETPN 4 way DB  | 4294 | 1 |
| 5079 45 | PPI conversion kit for<br>ETPN 6 way DB  | 4842 | 1 |
| 5079 46 | PPI conversion kit for<br>ETPN 8 way DB  | 5520 | 1 |
| 5079 47 | PPI conversion kit for<br>ETPN 12 way DB | 6212 | 1 |
| 5079 48 | PPI conversion kit for<br>ETPN 16 way DB | 6946 | 1 |

### Panel Locks

|         |                      |     |   |
|---------|----------------------|-----|---|
| 5079 52 | Panel knob for IP 43 | 474 | 1 |
| 5079 51 | Panel knob with key  | 989 | 1 |

Bold Cat.Nos are products normally available with Legrand (India) Stockists. Cat.Nos that are not bold - delivery within 4 - 8 weeks from the date of order. Bold packing quantity is our mandatory packing. Orders to be placed by Legrand (India) Stockist in multiples of the same.

### Plexo<sup>3</sup> Boxes for DX<sup>3</sup>

| Cat.Nos | Number of ways | MRP*<br>₹ / Unit | Pack |
|---------|----------------|------------------|------|
|---------|----------------|------------------|------|

Self-extinguishing: resistance to incandescent wire 650 °C

Conform to EN 60439-3

Weatherproof cabinets - IP 65 - IK 09 - Class II

Door and cabinet fully reversible

Removable chassis and faceplates from 2-row versions up

2-position rail for modular products and moulded cases

Spacing between rails 150 mm

Box colour light grey L750A, cover colour dark grey R746A

|         |               |      |   |
|---------|---------------|------|---|
| 6019 32 | 2 (+1) Module | 2581 | 1 |
| 6019 94 | 4 Module      | 2790 | 1 |
| 6019 96 | 6 Module      | 3186 | 1 |
| 6019 98 | 8 Module      | 3981 | 1 |



6019 94

#### Cabinets with 12 modules per row

|         |                   |       |   |
|---------|-------------------|-------|---|
| 6018 31 | 1 row 12 modules  | 6270  | 1 |
| 6018 32 | 2 rows 24 modules | 8699  | 1 |
| 6018 33 | 3 rows 36 modules | 12123 | 1 |



6018 32

\* MRP - Maximum Retail Price Inclusive of all taxes including GST.

### Plexo<sup>3</sup> Boxes for DX<sup>3</sup>

| Cat.Nos | Number ofWs | MRP*<br>₹ / Unit | Pack |
|---------|-------------|------------------|------|
|---------|-------------|------------------|------|

#### Cabinets with 18 modules per row

|         |                     |       |   |
|---------|---------------------|-------|---|
| 6018 35 | 18 modules x 1 row  | 7733  | 1 |
| 6018 36 | 18 modules x 2 rows | 13381 | 1 |
| 6018 37 | 18 modules x 3 rows | 18814 | 1 |
| 6018 38 | 18 modules x 4 rows | 28159 | 1 |

#### Multifunction sleeves for P17

|         |                    |      |   |
|---------|--------------------|------|---|
| 0019 17 | For 2 row cabinets | 4973 | 1 |
| 0019 18 | For 3 row cabinets | 7454 | 1 |
| 0019 67 | Joining kit        | 1408 | 1 |



6018 32 + 0019 17

Bold Cat.Nos are products normally available with Legrand (India) Stockists. Cat.Nos that are not bold - delivery within 4 - 8 weeks from the date of order. Bold packing quantity is our mandatory packing. Orders to be placed by Legrand (India) Stockist in multiples of the same.

## Plexo<sup>3</sup> Boxes for DX<sup>3</sup>

| Cat.Nos | Number ofWs | MRP*<br>₹ / Unit | Pack |
|---------|-------------|------------------|------|
|---------|-------------|------------------|------|

### Plexo-S

|         |                        |      |   |
|---------|------------------------|------|---|
| 6018 82 | Waterproof cabinet 2M  | 2063 | 1 |
| 6018 84 | Waterproof cabinet 4M  | 2429 | 1 |
| 6018 86 | Waterproof cabinet 6M  | 2792 | 1 |
| 6018 88 | Waterproof cabinet 8M  | 3436 | 1 |
| 6018 92 | Waterproof cabinet 12M | 5511 | 1 |
| 6018 94 | Waterproof cabinet 24M | 7590 | 1 |



6018 86



6018 94

## Accessories

### Fixing Lugs and Blanking Plates

|         |   |   |    |
|---------|---|---|----|
| 0019 69 | Set of 4 wall mounting lugs for Plexo, Plexo <sup>3</sup> cabinets and P17 combined units | ■ | 1  |
| 0019 61 | 5, seperable into modules or 1/2 module Grey RAL 7046                                     | ■ | 20 |

\* MRP - Maximum Retail Price Inclusive of all taxes including GST.

## Accessories

### Fixing Lugs and Blanking Plates

| Cat.Nos | Number ofWs | MRP*<br>₹ / Unit | Pack |
|---------|-------------|------------------|------|
|---------|-------------|------------------|------|

### Direct Piercing End Caps

|         |  |   |   |
|---------|--|---|---|
| 0019 56 | Pack consisting of 100 ø20 mm ISO and caps | ■ | 1 |
| 0019 57 | Pack consisting of 100 ø25 mm ISO and caps | ■ | 1 |

### Earth terminal and neutral terminal blocks

#### Brass Terminal Block with Isolated Support Conform to IEC 60998-2-1/2-2

|         |   |   |   |
|---------|---|---|---|
| 1348 00 | 1 X (2x16 <sup>2</sup> + 2x10 <sup>2</sup> ); ICC : 6kA | ■ | 1 |
| 1348 01 | 1 X (3x16 <sup>2</sup> + 3x10 <sup>2</sup> ); ICC : 6kA | ■ | 1 |
| 1348 10 | 2 X (2x16 <sup>2</sup> + 2x10 <sup>2</sup> ); ICC : 6kA | ■ | 1 |
| 1348 11 | 2 X (3x16 <sup>2</sup> + 3x10 <sup>2</sup> ); ICC : 6kA | ■ | 1 |

Bold Cat.Nos are products normally available with Legrand (India) Stockists. Cat.Nos that are not bold - delivery within 4 - 8 weeks from the date of order. Bold packing quantity is our mandatory packing. Orders to be placed by Legrand (India) Stockist in multiples of the same.

# PLEXO

## Weatherproof Enclosures

### The Go-To Range for Reliable Outdoor Installations



PLEXO enclosures deliver durable, weatherproof protection for modular electrical installations across indoor and outdoor environments. Featuring award-winning design, quick snap-fit assembly, and flexible configurations, they ensure faster installations and reliable performance in demanding site conditions.

### Features

- Reversible modular design supporting 1–7 module configurations with transparent or opaque covers
- Tool-free snap-fit assembly for quick installation and flexible alignment
- High protection ratings with IP55–IP66 sealing and IK07–IK09 impact resistance
- Durable, eco-compliant materials with 650°C self-extinguishing capability

### Benefits

- Reduces installation time with fast snap-fit mounting and flexible wiring space
- Performs reliably in harsh environments like garages, car parks, and wash areas
- Enables quick visual inspection using transparent protective covers
- Supports scalable installations with modular designs and smart-ready options



Scan to know more about the product.



## Ekinox<sup>3</sup>

For converting ETPN DB to PPI DB

### PPI DB IP 30 - IK 08

| No. of ways | Combine          |                      | No. of modules |
|-------------|------------------|----------------------|----------------|
|             | ETPN DB          | PPI Kit              |                |
| 4 way       | 4 way<br>507660  | 4 way kit<br>507944  | 8+12           |
| 6 way       | 6 way<br>507661  | 6 way kit<br>507945  | 8+18           |
| 8 way       | 8 way<br>507662  | 8 way kit<br>507946  | 8+24           |
| 12 way      | 12 way<br>507663 | 12 way kit<br>507947 | 8+36           |
| 16 way      | 16 way<br>507664 | 16 way kit<br>507948 | 8+48           |

### PPI DB IP 43 - IK 09 with metal door

| No. of ways | Combine          |                      | No. of modules |
|-------------|------------------|----------------------|----------------|
|             | ETPN DB          | PPI Kit              |                |
| 4 way       | 4 way<br>507670  | 4 way kit<br>507944  | 8+12           |
| 6 way       | 6 way<br>507671  | 6 way kit<br>507945  | 8+18           |
| 8 way       | 8 way<br>507672  | 8 way kit<br>507946  | 8+24           |
| 12 way      | 12 way<br>507673 | 12 way kit<br>507947 | 8+36           |
| 16 way      | 16 way<br>507674 | 16 way kit<br>507948 | 8+48           |

### PPI DB IP 43 - IK 09 with acrylic door

| No. of ways | Combine          |                      | No. of modules |
|-------------|------------------|----------------------|----------------|
|             | ETPN DB          | PPI Kit              |                |
| 4 way       | 4 way<br>507680  | 4 way kit<br>507944  | 8+12           |
| 6 way       | 6 way<br>507681  | 6 way kit<br>507945  | 8+18           |
| 8 way       | 8 way<br>507682  | 8 way kit<br>507946  | 8+24           |
| 12 way      | 12 way<br>507683 | 12 way kit<br>507947 | 8+36           |
| 16 way      | 16 way<br>507684 | 16 way kit<br>507948 | 8+48           |

### PPI DB IP 54 - IK 09

| No. of ways | Combine          |                      | No. of modules |
|-------------|------------------|----------------------|----------------|
|             | ETPN DB          | PPI Kit              |                |
| 4 way       | 4 way<br>507690  | 4 way kit<br>507944  | 8+12           |
| 6 way       | 6 way<br>507691  | 6 way kit<br>507945  | 8+18           |
| 8 way       | 8 way<br>507692  | 8 way kit<br>507946  | 8+24           |
| 12 way      | 12 way<br>507693 | 12 way kit<br>507947 | 8+36           |
| 16 way      | 16 way<br>507694 | 16 way kit<br>507948 | 8+48           |

## IK

Protection against mechanical impact: protection index - IK

According to standard:

IEC 62262, BS EN 62262 and NF EN 62262

• This table can be used to ascertain the resistance of a product to an impact given in Joules from the IK code (graduated from 00 to 10)

It can also be used to ascertain the correspondence with the old IP code 3rd digit and the corresponding external "Ag" conditions

| IK    | Tests | Impact energy (in Joules) | "AG" of NF C 15-100 |
|-------|-------|---------------------------|---------------------|
| IK 00 |       | 0                         |                     |
| IK 01 |       | 0.15                      |                     |
| IK 02 |       | 0.2                       | AG1                 |
| IK 03 |       | 0.35                      |                     |
| IK 04 |       | 0.5                       |                     |
| IK 05 |       | 0.7                       |                     |
| IK 06 |       | 1                         |                     |
| IK 07 |       | 2                         | AG2                 |
| IK 08 |       | 5                         | AG3                 |
| IK 09 |       | 10                        |                     |
| IK 10 |       | 20                        | AG4                 |

## IPXX

### Index of protection

IP\*\*\* index of protection of enclosures of electrical equipment in accordance with standards IEC 529, BS 5490, DIN 400 50 and NF C 20-010  
Up to 1000 V± and 1500 V= (standard UTE C 20 010)

#### 1st figure:- protection against solid bodies

| IP | tests |  |
|----|-------|--|
| 0  |       | No protection  |
| 1  |       | Protected against solid bodies larger than 50 mm (eg:- accidental contact with the hand) |
| 2  |       | Protected against solid bodies larger than 12 mm (eg:- finger)                           |
| 3  |       | Protected against solid bodies larger than 2.5 mm (eg:- tools, wires)                    |
| 4  |       | Protected against solid bodies larger than 1 mm (eg:- fine tools and small wires)        |
| 5  |       | Protected against dust (no harmful deposit)  |
| 6  |       | Completely protected against dust  |

#### 2nd figure:- protection against liquids

| IP | tests |   |
|----|-------|---|
| 0  |       | No protection   |
| 1  |       | Protected against vertically-falling drops of water (condensation)      |
| 2  |       | Protected against drops of water falling at up to 15° from the vertical |
| 3  |       | Protected against drops of rain water at up to 60° from the vertical    |
| 4  |       | Protected against projections of water from all directions              |
| 5  |       | Protected against jets of water from all directions                     |
| 6  |       | Protected against jets of water of similar force to heavy seas          |
| 7  |       | Protected against the effects of immersion                              |
| 8  |       | Protected against prolonged effects of immersion under pressure         |

The contents of all the above charts are for guidance only, if you have any doubt as to the interpretation of the information contained therein, please refer either to the standard itself or contact Legrand.

In accordance with our policy of continuous improvement, Legrand reserves the right to change specifications and designs without notice. All information given here is correct at the time of going to press.

# Dizly

SEAMLESS DEZIRE

Don't hide,  
Flaunt it!



Stylish Distribution Boards for every interior.

Dizly range enhances any space with its stylish design while ensuring safety. The metal finish adds a touch of class that's sure to impress every time.

## Benefits

- Enhances interiors with a seamless and modern look
- Simplifies installation and wiring with user-friendly design
- Ensures reliable and safe performance
- Delivers long-term durability with robust build quality

Scan to know more about  
the product.



## Dizly Distribution Board

### Product Features

**Suitable for Flush Mounting and Surface Mounting**  
Mounting key holes are provided in every Dizly DB, as an option for surface mounting

**Ease of Wiring**  
Adequate wiring space is provided

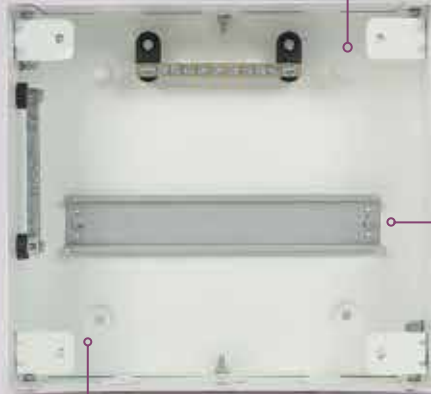

**Ensuring Reliability and Safety**  
Designed as per Indian & Internationally accepted Standard

**Sturdy & Robust**  
Manufactured with high precision and high quality CRCA steel sheets

**Striking Design**  
Superior design & finish that blends seamlessly with all kinds of interior decor.

**Colour**  
Pristine white in colour with matt finishing



**An Unmatched Innovation**  
Knobless Opening & Closing of door



4023 61



4023 66



4023 71



4023 75

| Cat.Nos | Description | MRP*<br>₹ / Unit | Number of Modules |
|---------|-------------|------------------|-------------------|
|---------|-------------|------------------|-------------------|

#### SPN IP 20 Single Door

|         |                 |      |    |
|---------|-----------------|------|----|
| 4023 60 | SPN 6W IP20 DB  | 1418 | 6  |
| 4023 61 | SPN 8W IP20 DB  | 1497 | 8  |
| 4023 62 | SPN 10W IP20 DB | 1735 | 10 |
| 4023 63 | SPN 12W IP20 DB | 2252 | 12 |
| 4023 64 | SPN 14W IP20 DB | 2442 | 14 |

#### SPN IP 42 Double Door

|         |                 |      |    |
|---------|-----------------|------|----|
| 4023 65 | SPN 6W IP42 DB  | 2424 | 6  |
| 4023 66 | SPN 8W IP42 DB  | 2717 | 8  |
| 4023 67 | SPN 10W IP42 DB | 3122 | 10 |
| 4023 68 | SPN 12W IP42 DB | 3276 | 12 |
| 4023 69 | SPN 14W IP42 DB | 3622 | 14 |
| 4023 80 | SPN 16W IP42 DB | 4559 | 16 |

#### TPN IP 20 Single Door

|         |                  |      |      |
|---------|------------------|------|------|
| 4023 70 | ETPN 4W IP20 DB  | 4031 | 4+12 |
| 4023 71 | ETPN 6W IP20 DB  | 4852 | 4+18 |
| 4023 72 | ETPN 8W IP20 DB  | 6446 | 8+24 |
| 4023 73 | ETPN 12W IP20 DB | 6934 | 8+36 |

#### TPN IP 42 Double Door

|         |                    |       |      |
|---------|--------------------|-------|------|
| 4023 74 | ETPN 4W IP42 DB    | 5203  | 4+12 |
| 4023 78 | ETPN 4W 8M IP42 DB | 6209  | 8+12 |
| 4023 75 | ETPN 6W IP42 DB    | 6444  | 4+18 |
| 4023 79 | ETPN 6W 8M IP42 DB | 7320  | 8+18 |
| 4023 76 | ETPN 8W IP42 DB    | 8351  | 8+24 |
| 4023 77 | ETPN 12W IP42 DB   | 12133 | 8+36 |

\* MRP - Maximum Retail Price Inclusive of all taxes including GST.

# ARTEOR™ ADVANCE

FEEL SOMETHING NEW

## Premium Wiring Devices for Fine Living



Arteor™ Advance is a premium wiring device range designed for luxury residences, offices, and hospitality spaces. It combines refined aesthetics, innovative mechanisms, and smart connectivity to deliver elegant functionality for modern interiors.

### Features

- Dual rocker styles with Classic and Elite designs
- Premium finish collections including Matt, Decor, Metal, and Statement full-metal plates
- Integrated plate adjuster for precise alignment on uneven walls
- Smart-ready features such as contactless switches, motion sensors, and hotel keycard controls

### Benefits

- Elevates interior design with premium finishes and modern styling
- Supports connected living with integrated charging and smart control options
- Provides versatile solutions for residential, office, and hospitality spaces
- Ensures long-lasting performance with durable aluminium plates and refined build quality



# Celebrating Design That Elevates Every Space



Scan to know more about  
the product.



ARTEOR™  
ADVANCE  
FEEL SOMETHING NEW

---

# Two Forms, One Design Concept

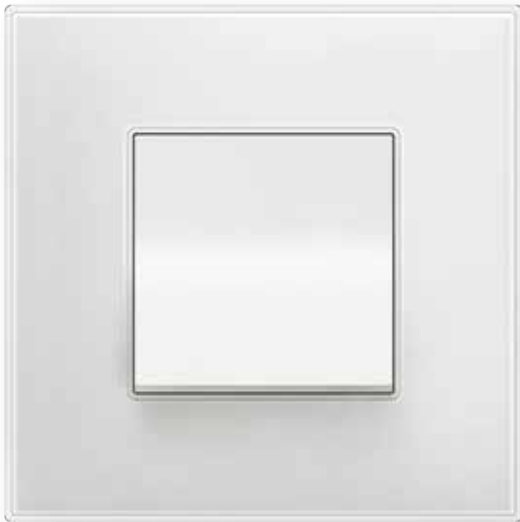

CLASSIC

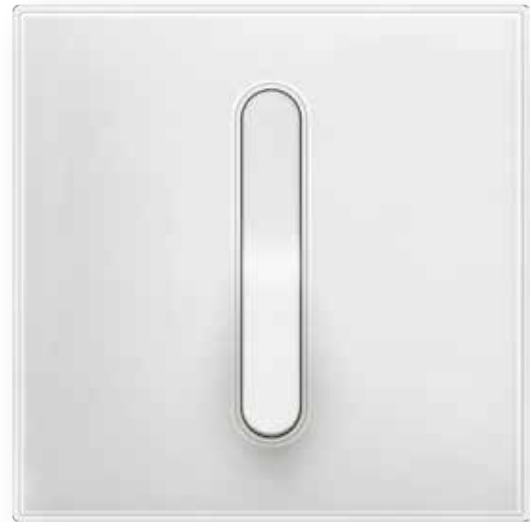

ELITE

## Design language

Arteor Advance is available in two design lines, with clearly different rocker formats. The Classic design gives a whole new dimension to a classic form. The Elite rocker is a completely new design embodying the trends of the future.

## Floating rocker

The impression created by the floating rocker is the same for both types: Light and elegant, it seems to float above the plate. Both forms can be combined to great effect as well. The Elite version allows you to make a clear statement, while the Classic version is more subtle and discreet.

# FINISHES

Statement Collection  
FULL METAL

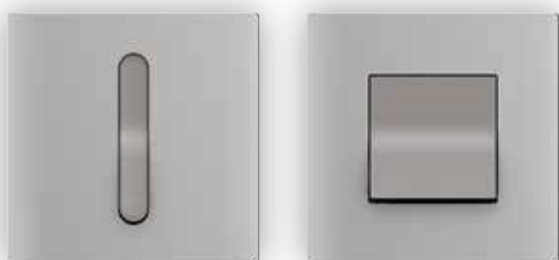

Decor Collection  
FROSTED FINISHES



Classic Collection  
BASIC NEUTRAL



Decor Collection  
Metal Finishes



# ARTEOR™ ADVANCE

FEEL SOMETHING NEW

## Modular Design for Maximum Flexibility

The modular architecture of the range allows to integrate a wide range of different functions within a single plate, whatever the installation standard.



Even where space is scarce, individual configurations are possible.



Full modularity for maximum flexibility.

## One Plate, Two Designs – Perfect Integration

Modularity is also maintained when you want to use both ergonomics, Classic and Elite in one plate. Thanks to special hybrid plates, both design lines can be combined in one plate at the same time, for more creative possibilities with a harmonious look.

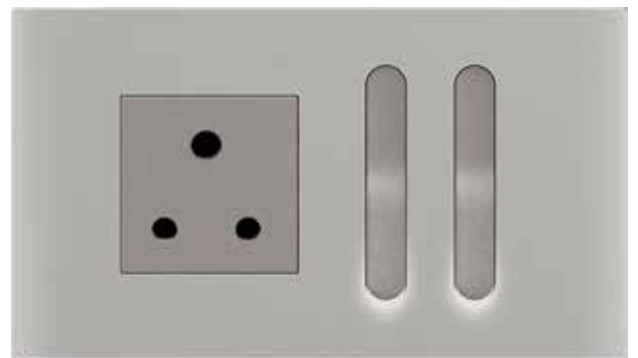

Switches in Elite design are easy to combine with socket outlets, dimmers, or USB chargers. Maximum flexibility for a wealth of combinations and a perfect look even when space is limited.

# Pioneering a Sustainable Future with Bio-plastic Innovation



Innovation at Legrand goes beyond the product. Arteor Advance is our first range to feature packaging made with an innovative bio-plastic material. This pioneering eco-packaging solution is 90% biobased and is designed to lower carbon emissions by up to 70%. A conscious step towards a greener product lifecycle and a better future.

# ARTEOR™ ADVANCE

FEEL SOMETHING NEW

## Live As You Want

Everyone has their own ideas about how to arrange their living space, and people's individual preferences regarding the functionality of electrical equipment will vary widely too. With Arteor Advance, everyone can arrange their own private space accordingly and accommodate as much comfort or energy saving as they want. All in a premium consistent design.





## Exploiting Every Potential

The new generation of LED dimmers and LED automatic switches are fully LED compatible and can also be used for all other types of modern loads. This makes it possible to exploit the full energy saving potential of LEDs, without losing out on convenience.



Switch with indicator

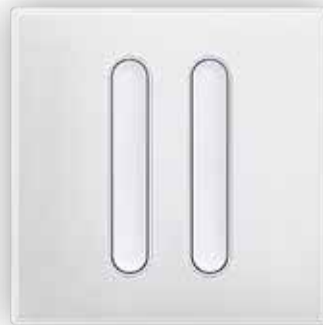

Smart 2-gang wireless batteryless light switch



Rotary fan controller



Double switch for electric shutter



USB Type C+C 30W PD Charger

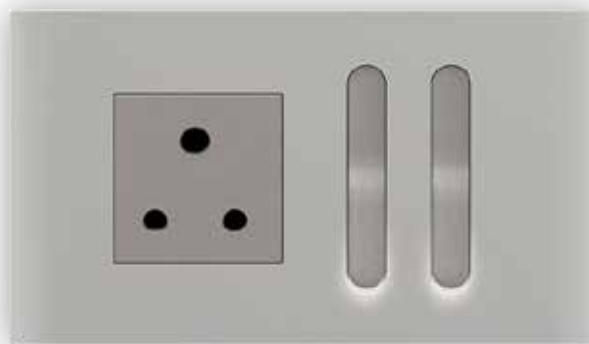

6A - 3 pin ISI Socket with 10A Elite Switch with Locator



TV-R-SAT sockets

## Intelligent & Powerful: The New Usb Chargers

Arteor Advance meets the current USB-C standard with new chargers that integrate harmoniously into the design of the rest of the electrical installation. In addition to their design, they also impress with their performance; they are powerful enough to charge laptops. They also enable "fast charging" and protect the batteries of the connected devices with Power Delivery as they only supply as much power as is needed for charging. Available in 20W, 30W, 45W and 65W.

# ARTEOR™ ADVANCE

FEEL SOMETHING NEW

## Working with Arteor™ Advance

The boundaries between life and work are becoming increasingly blurred. That's why Arteor Advance offers solutions that make life and work both easier and more comfortable, while making optimal use of the possibilities offered by connectivity. The understated design improves both quality of life and productivity.

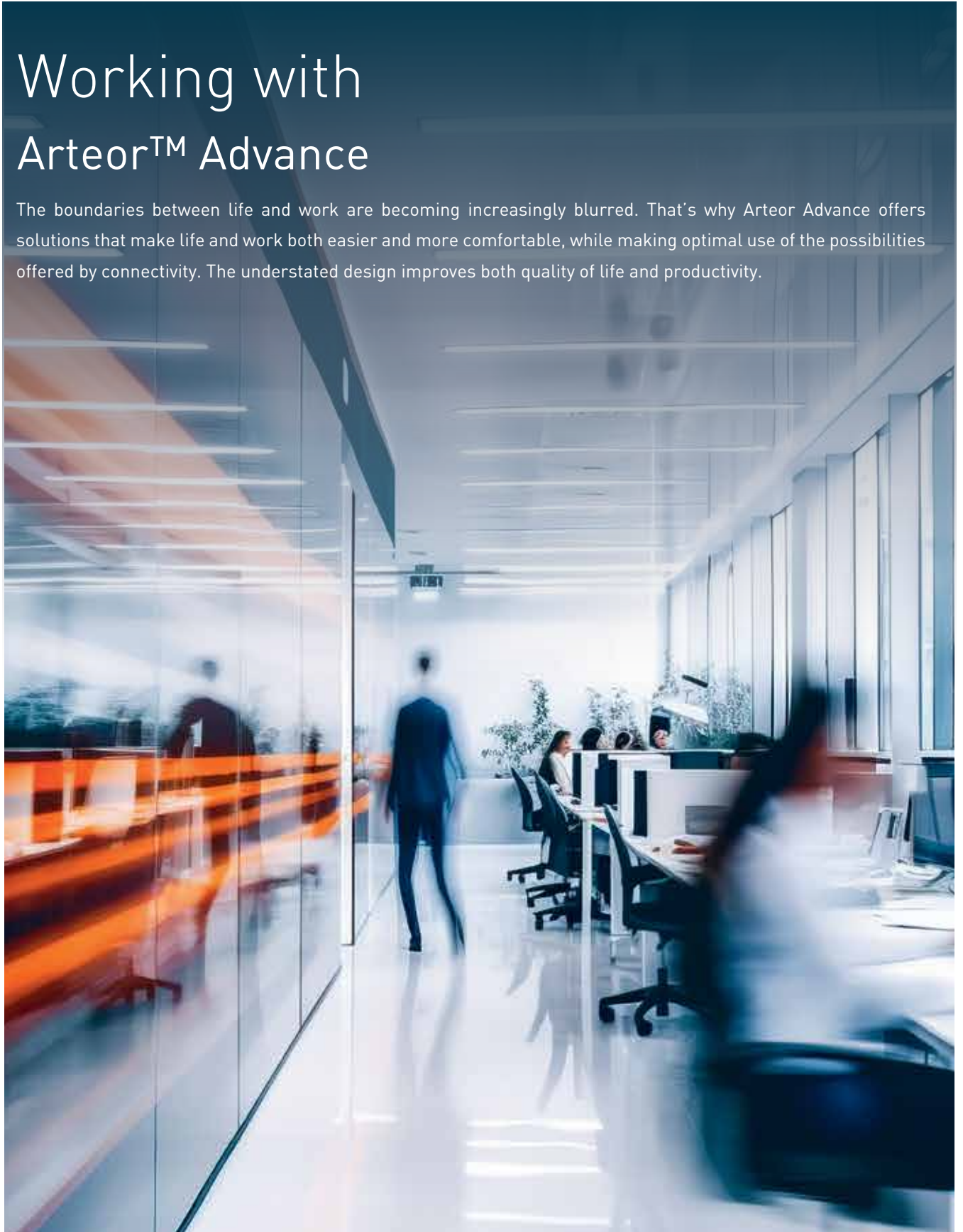



Arteor Advance mechanisms can be incorporated into Pop-Up boxes or Desk devices of the Incara range: seamless integration into furniture - power and data within easy reach.



All-in-one consistent design:

Power supply for all devices, data outlets and USB chargers with enough power for charging a laptop.



LED compatible motion sensors help to save energy as they only switch lights on when needed.

## Contactless Switching

A new switch offers a more hygienic way of using lights and doors. It controls lights or opens doors without direct contact. Just position your hand close by, and the desired action will be triggered. In offices, hotels and anywhere lots of people use switches, the contactless switch is a valuable and convenient alternative to traditional solutions.



Contactless switch for control of lights or doors.

ARTEOR™  
ADVANCE  
FEEL SOMETHING NEW

---

Welcome to the  
Arteor™ Advance Hotel

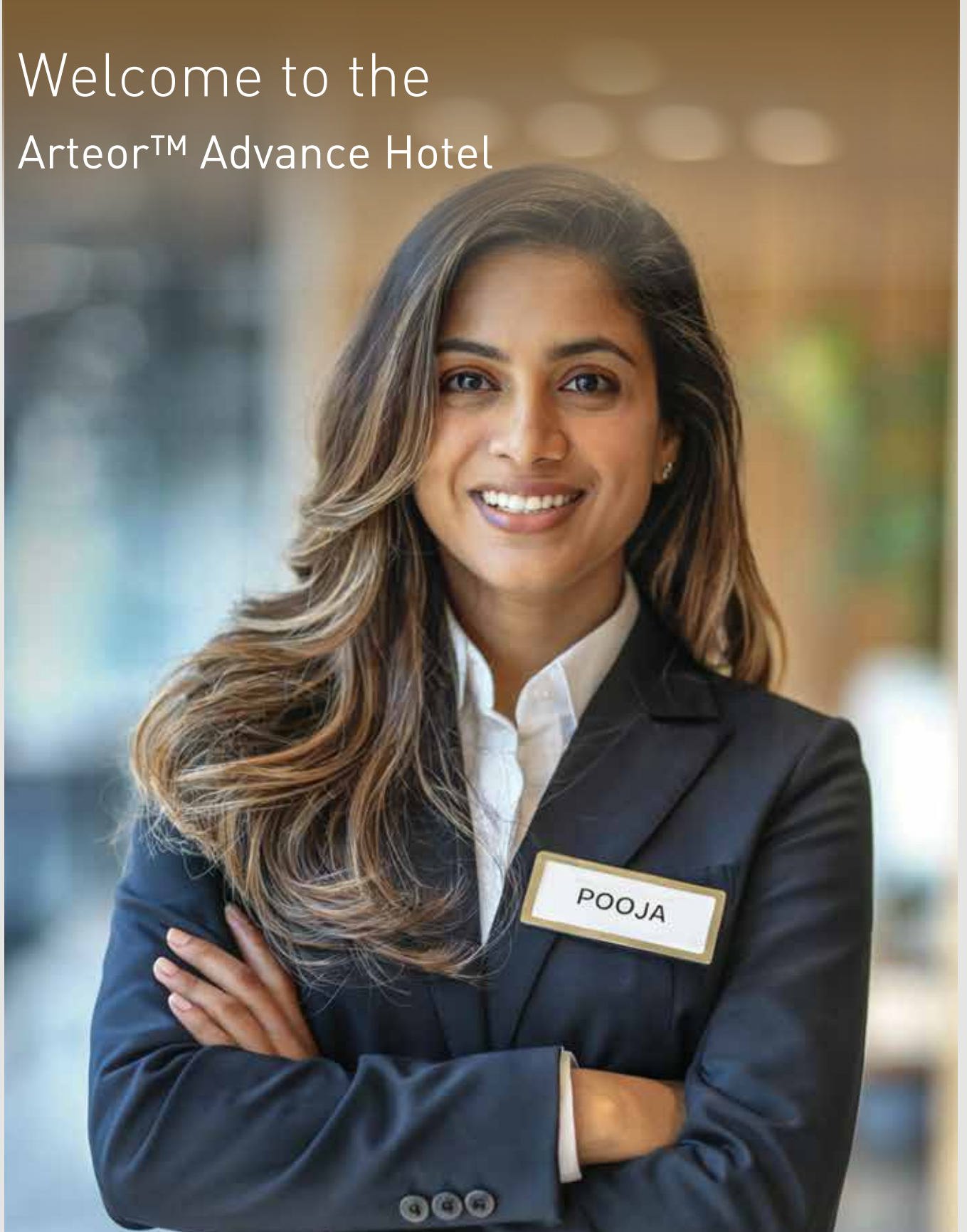



Key-Card Switch



Hotel room call indicator External unit: displays calls in the corridor.



Bedside panel: Dedicated markings allow for easy identification of the different functions: Master ON/OFF, control of bedlights, curtains, roller blinds, and more.



Internal unit: allows to select the desired setting "Do not disturb/ Make up room".



USB Type C 45W PD Charger



Double USB Type-C charger, 65 W, Fast charge feature: Power Delivery

















Shaver Socket

## Lots of power with gentle fast charging

USB chargers are an essential feature, and not just for mobile working. They provide enough energy to charge laptops and other devices. The batteries are charged in a particularly resource-efficient manner by intelligently adjusting the charging current to the needs of the devices connected.

## Arteor Advance™















**NEW!** Classic Matt White Mechanisms

| Cat.Nos   | Description   | MRP*<br>₹ / Unit | Pack     |
|---|---|------------------|----------|
| <b>Switches – 10A - 230V AC</b>   |   |                  |          |
|  AC21104MW   | 10A - Switch - 1 Way - 1 Module                       | 264              | 1/20/200 |
|  AC21106MW   | 10A - Switch - 1 Way - with Indicator - 1 Module      | 488              | 1/20/200 |
|  AC21105MW   | 10A - Switch - 1 Way - with Locator - 1 Module        | 488              | 1/20/200 |
|  AC21102MW   | 10A - Switch - 1 Way - with Locator (Blue) - 1 Module | 488              | 1/20/200 |
|  AC22105MW   | 10A - Switch - 2 Way - 1 Module                       | 432              | 1/20/200 |
|  AC22107MW | 10A - Switch - 2 Way - with Indicator - 1 Module      | 608              | 1/20/200 |
|  AC21119MW | 10A - Switch - 1 Way - with Indicator - 2 Module      | 590              | 1/10/100 |
| <b>Switches – 16A - 230V AC</b>   |   |                  |          |
|  AC21101MW | 16A - Switch - 1 Way - 1 Module                       | 442              | 1/20/200 |
|  AC21118MW | 16A - Switch - 1 Way - with Indicator - 1 Module      | 562              | 1/20/200 |
|  AC22101MW | 16A - Switch - 2 Way - 1 Module                       | 690              | 1/20/200 |
|  AC22102MW | 16A - Switch - 2 Way - with Indicator - 1 Module      | 700              | 1/20/200 |
|  AC21103MW | 16A - Switch - 1 Way - 2 Module                       | 590              | 1/10/100 |
|  AC20109MW | 16A - Intermediate Switch - 230V AC - 2 Module        | 3444             | 1/10/100 |
|  AC22109MW | 16A - Switch - 2 Way - 2 Module                       | 970              | 1/10/100 |
| <b>Switches – 20A - 230V AC</b>   |   |                  |          |
|  AC21107MW | 20A - Switch - 1 Way - 1 Module                       | 586              | 1/20/200 |
|  AC21108MW | 20A - Switch - 1 Way - with Indicator - 1 Module      | 664              | 1/20/200 |
|  AC22106MW | 20A - Switch - 2 Way - 1 Module                       | 760              | 1/20/200 |
|  AC22108MW | 20A - Switch - 2 Way - with Indicator - 1 Module      | 846              | 1/20/200 |
|  AC21112MW | 20A - Switch - 1 Way - 2 Module                       | 698              | 1/10/100 |
|  AC22119MW | 20A - Switch - 2 Way - 2 Module                       | 828              | 1/10/100 |

\* MRP - Maximum Retail Price Inclusive of all taxes including GST.  
Red Cat. Nos - New Products

## Arteor Advance™

**NEW!** Classic Matt White Mechanisms

| Cat.Nos   | Description  | MRP*<br>₹ / Unit | Pack     |
|---|--|------------------|----------|
| <b>Switches – 20A - 230V AC</b>   |  |                  |          |
|  AC22113MW   | 20A - Switch - 2 Way - with Indicator - 2 Module                             | 918              | 1/10/100 |
|  AC21312MW   | 20A - Switch - 3 Gang - 1 Way - 2 Module                                     | 1652             | 1/10/100 |
|  AC29101MW   | 20A - Switch - 3 Gang - 2X2 Way + 1X1 Way - 2 Module                         | 1810             | 1/10/100 |
|  AC21113MW   | 20A - Switch - DP - 1 Way - with Indicator - 2 Module                        | 1302             | 1/10/100 |
|  AC20105MW   | 20A - Switch - DP - 1 Way - with Indicator & Water Heater Marking - 2 Module | 1364             | 1/10/100 |
| <b>Switches – 25A - 230V AC</b>   |  |                  |          |
|  AC21115MW | 25A - Switch - 1 Way - with Indicator - 1 Module                             | 786              | 1/20/200 |
| <b>Switches – 32A - 230V AC</b>   |  |                  |          |
|  AC20101MW | 32A - Switch - DP - 1 Way - with Indicator - 2 Module                        | 1858             | 1/10/100 |
| <b>Push Button – 10A - 230V AC</b>  |  |                  |          |
|  AC23102MW | 10A - Bell Push - 1 Way - 1 Module   | 484              | 1/20/200 |
|  AC23103MW | 10A - Bell Push - 1 Way - with Locator - 1 Module                            | 642              | 1/20/200 |
|  AC23104MW | 10A - Bell Push - 1 Way - with Locator (Blue) - 1 Module                     | 642              | 1/20/200 |
|  AC23111MW | 10A - Bell Push - 1 Way - 2 Module   | 682              | 1/10/100 |
|  AC23112MW | 10A - Bell Push - 1 Way - with Locator - 2 Module                            | 914              | 1/10/100 |
|  AC23121MW | 10A - Bell Push - 1 Way - with Locator (Blue) - 2 Module                     | 914              | 1/10/100 |
|  AC23106MW | 10A - Push Button - 1 Way - 1 Module   | 512              | 1/20/200 |
|  AC23107MW | 10A - Push Button - 1 Way - with Locator - 1 Module                          | 648              | 1/20/200 |
|  AC23120MW | 10A - Push Button - 1 Way - with Locator (Blue) - 1 Module                   | 648              | 1/20/200 |
|  AC23108MW | 10A - Push Button - 2 Way - 1 Module   | 714              | 1/10/100 |

Bold Cat.Nos are products normally available with Legrand (India) Stockists. Cat.Nos that are not bold - delivery within 4 - 8 weeks from the date of order. Bold packing quantity is our mandatory packing. Orders to be placed by Legrand (India) Stockist in multiples of the same.

## Arteor Advance™

**NEW!** Classic Matt White Mechanisms

| Cat.Nos | Description | MRP*<br>₹ / Unit | Pack |
|---------|-------------|------------------|------|
|---------|-------------|------------------|------|

### Accessories for Classic and Elite Switches with Locator and Indicator

|             |                                      |     |        |
|-------------|--------------------------------------|-----|--------|
| <b>A180</b> | Red LED for Indicator 230 V          | 108 | 10/100 |
| <b>A186</b> | Blue LED for Locator 230 V           | 108 | 10/100 |
| <b>A187</b> | Warm white LED for Locator 230 V 0.8 | 108 | 10/100 |
| <b>A188</b> | Warm white LED for Locator 230 V 0.3 | 108 | 10/100 |

### Electric Roller Blinds

|                  |   |      |          |
|------------------|---|------|----------|
| <b>AC26104MW</b> | Double Switch for Electric Shutter - 2 Module | 1184 | 1/10/100 |
|------------------|---|------|----------|

### Dimmers and Fan Regulators

|                  |  |       |          |
|------------------|--|-------|----------|
| <b>AC24103MW</b> | Light Dimmer - 60 to 400 Watts - 2 Module            | 1996  | 1/10/100 |
| <b>AC24105MW</b> | Push Dimmer 0-10V - 2 Module                         | 12810 | 1/20     |
| <b>AC24101MW</b> | Push Dimmer 150W With Neutral - 1 Module             | 18302 | 1/5/20   |
| <b>AC24104MW</b> | Push Dimmer 125W Without Neutral - 2 Module          | 11896 | 1/20     |
| <b>AC24106MW</b> | Touch Dimmer 5-300W/75W - 2 Module                   | 10980 | 1/20     |
| <b>AC24107MW</b> | Rotary Dimmer 200W LED - 2 Module                    | 20132 | 1/10     |
| <b>AC661MW</b>   | Fan Step Regulator - 100 Watts - ISI - 1 Module      | 1604  | 1/5/50   |
| <b>AC662MW</b>   | Fan Step Regulator - 100 Watts - ISI - 2 Module      | 1980  | 1/10/100 |
| <b>AC665MW</b>   | Fan Step Regulator - 70 Watts - ISI - 2 Module       | 2110  | 1/10/100 |
| <b>AC663MW</b>   | Fan Step Regulator - 120 Watts - ISI - 2 Module      | 2118  | 1/10/100 |
| <b>AC664MW</b>   | Fan Regulator - 8 Steps - 100 Watts - ISI - 2 Module | 1886  | 1/10/100 |

## Arteor Advance™

**NEW!** Classic Matt White Mechanisms

| Cat.Nos | Description | MRP*<br>₹ / Unit | Pack |
|---------|-------------|------------------|------|
|---------|-------------|------------------|------|

### Indian Standard Sockets

|                 |   |     |          |
|-----------------|---|-----|----------|
| <b>AC3163MW</b> | 6A - Socket - with Shutter - 3 Pin - ISI - 2 Module             | 404 | 1/20/200 |
| <b>AC3166MW</b> | 6/16A - Socket - with Shutter - 3 Pin - Indian - ISI - 2 Module | 818 | 1/10/100 |
| <b>AC3167MW</b> | 6/16A - Socket - with Shutter - 3 Pin - Indian - ISI - 3 Module | 980 | 1/5/50   |

### Energy Plugs

|                |            |     |        |
|----------------|------------|-----|--------|
| <b>AC100MW</b> | 6A - Plug  | 192 | 10/100 |
| <b>AC101MW</b> | 16A - Plug | 256 | 10/100 |

### USB Chargers

|                 |   |       |          |
|-----------------|---|-------|----------|
| <b>AC3408MW</b> | USB Charger - 3000mA/15 Watts - Type A - 1 Module               | 3668  | 1/10/150 |
| <b>AC3410MW</b> | USB Charger - 3000mA/15 Watts - Type A + A - 1 Module           | 4150  | 1/10/150 |
| <b>AC3411MW</b> | USB Charger - 3000mA/15 Watts - Type A + C - 1 Module           | 4626  | 1/10/150 |
| <b>AC3412MW</b> | USB Charger - 3000mA/15 Watts - Type C + C - 1 Module           | 5178  | 1/10/150 |
| <b>AC3409MW</b> | USB Charger - Power Delivery - 20 Watts - Type C - 1 Module     | 7090  | 1/10/150 |
| <b>AC3406MW</b> | USB Charger - Power Delivery - 30 Watts - Type C + C - 2 Module | 10610 | 1/20     |
| <b>AC3401MW</b> | USB Charger - Power Delivery - 45 Watts - Type C - 2 Module     | 13690 | 1/20     |
| <b>AC3415MW</b> | USB Charger - Power Delivery - 65 Watts - Type C + C - 3 Module | 16766 | 1/20     |

### Data and Voice

|                 |  |      |          |
|-----------------|--|------|----------|
| <b>AC423MW</b>  | Telephone Socket - Double RJ11 - 1 Module                        | 746  | 1/20/200 |
| <b>AC424MW</b>  | Telephone Socket - RJ11 - with Shutter - 1 Module                | 434  | 1/20/200 |
| <b>AC4306MW</b> | Information Socket - RJ45 - Cat 6A - UTP - 1 Module              | 1946 | 10/100   |
| <b>AC4315MW</b> | Information Socket - RJ45 Rear Pluggable - CAT6 - UTP - 2 Module | 5356 | 1/10/100 |

### TV Sockets

|                 |                                 |     |          |
|-----------------|---------------------------------|-----|----------|
| <b>AC4110MW</b> | TV Co - axial Socket - 1 Module | 446 | 1/20/200 |
|-----------------|---------------------------------|-----|----------|

\* MRP - Maximum Retail Price Inclusive of all taxes including GST.  
Red Cat. Nos - New Products

Bold Cat.Nos are products normally available with Legrand (India) Stockists. Cat.Nos that are not bold - delivery within 4 - 8 weeks from the date of order. Bold packing quantity is our mandatory packing. Orders to be placed by Legrand (India) Stockist in multiples of the same.

## Arteor Advance™

### NEW! Classic Matt White Mechanisms

| Cat.Nos | Description | MRP*<br>₹ / Unit | Pack |
|---------|-------------|------------------|------|
|---------|-------------|------------------|------|

#### Electronic Chime

|                |                                  |     |          |
|----------------|----------------------------------|-----|----------|
| <b>AC618MW</b> | Bell Ding Dong - 230V - 2 Module | 800 | 1/10/100 |
|----------------|----------------------------------|-----|----------|

#### Buzzer

|                |                          |      |       |
|----------------|--------------------------|------|-------|
| <b>AC615MW</b> | Buzzer - 230V - 1 Module | 2114 | 10/60 |
|----------------|--------------------------|------|-------|

#### Bell Call Indicator

|                  |                                |      |          |
|------------------|--------------------------------|------|----------|
| <b>AC23105MW</b> | Bell Call Indicator - 1 Module | 3070 | 1/20/200 |
|------------------|--------------------------------|------|----------|

#### Infrared Sensors

|                  |  |       |      |
|------------------|--|-------|------|
| <b>AC25102MW</b> | IR Motion Sensor with Neutral - 2 Module | 12920 | 1/20 |
|------------------|--|-------|------|

#### Innovative Switch

|                  |   |      |      |
|------------------|---|------|------|
| <b>AC28102MW</b> | Contactless Door Switch - 12-24-48 V - 2 Module | 7466 | 1/20 |
|------------------|---|------|------|

|                  |   |      |      |
|------------------|---|------|------|
| <b>AC28101MW</b> | Contactless Light Switch - 230V AC - 2 Module | 6718 | 1/20 |
|------------------|---|------|------|

#### Skirting Light

|                |   |      |        |
|----------------|---|------|--------|
| <b>AC653MW</b> | Skirting Light - with LED - 230V - 3 Module | 1648 | 10/100 |
|----------------|---|------|--------|

|              |  |       |      |
|--------------|--|-------|------|
| <b>AC652</b> | Removable Plug-in Skirting Light - 230V - 2 Module | 25012 | 1/12 |
|--------------|--|-------|------|

#### Lighting

|              |  |     |      |
|--------------|--|-----|------|
| <b>AC654</b> | Over Door Light Unit White/Red/Green/Blue - 2 Module | 762 | 1/50 |
|--------------|--|-----|------|

|              |  |      |        |
|--------------|--|------|--------|
| <b>AC655</b> | Indicator Unit - with transparent & Colored Labels- 1 Module | 1234 | 10/100 |
|--------------|--|------|--------|

|              |   |      |      |
|--------------|---|------|------|
| <b>AC656</b> | Illuminated Light unit with 4 LED colours (white/red/green/blue) - 2 Module | 1360 | 5/50 |
|--------------|---|------|------|

## Hospitality Function

### Hotel "DND and MMR" functions

|                  |  |      |          |
|------------------|--|------|----------|
| <b>AC27107MW</b> | Interlocked Internal DND & MMR Control Unit - 2 Module | 2364 | 1/10/100 |
|------------------|--|------|----------|

|                  |   |      |        |
|------------------|---|------|--------|
| <b>AC27108MW</b> | External DND & MMR Control Unit - with Bell Push - 2 Module | 3298 | 1/5/50 |
|------------------|---|------|--------|

### Hotel Keycard Switch

|                  |   |      |      |
|------------------|---|------|------|
| <b>AC27110MW</b> | 16A - Key Card Switch - 230V - 2 Module | 9000 | 1/20 |
|------------------|---|------|------|

|                  |   |      |      |
|------------------|---|------|------|
| <b>AC27111MW</b> | 16A - Key Card Switch with RFID - 230V - 2 Module | 9388 | 1/20 |
|------------------|---|------|------|

|               |                                   |     |   |
|---------------|-----------------------------------|-----|---|
| <b>679255</b> | Key Fob for Key Card Switch White | 234 | - |
|---------------|-----------------------------------|-----|---|

## Arteor Advance™

### NEW! Hospitality Funtion

| Cat.Nos | Description | MRP*<br>₹ / Unit | Pack |
|---------|-------------|------------------|------|
|---------|-------------|------------------|------|

#### Hotel Keycard Switch

|               |                                  |      |        |
|---------------|----------------------------------|------|--------|
| <b>076711</b> | Key Fob for RFID Key Card Switch | 2698 | 10/200 |
|---------------|----------------------------------|------|--------|

#### Shaver Socket

|                |  |      |      |
|----------------|--|------|------|
| <b>AC361MW</b> | Shaver Socket - 230V/120 - 230V - with Earth Connector | 9354 | 1/10 |
|----------------|--|------|------|

#### Time Switch

|                  |                              |       |      |
|------------------|------------------------------|-------|------|
| <b>AC20110MW</b> | Time Delay Switch - 2 Module | 11044 | 1/20 |
|------------------|------------------------------|-------|------|

#### Master Switch

|                  |  |     |          |
|------------------|--|-----|----------|
| <b>AC22114MW</b> | 20A - Master Switch - DP - 2 Way - ON/OFF - 2 Module | 812 | 1/10/100 |
|------------------|--|-----|----------|

|                  |                                       |     |          |
|------------------|---------------------------------------|-----|----------|
| <b>AC23115MW</b> | Master Push ON/OFF - 2 Way - 2 Module | 794 | 1/10/100 |
|------------------|---------------------------------------|-----|----------|

#### Bedlight Switch

|                  |  |     |        |
|------------------|--|-----|--------|
| <b>AC21117MW</b> | 10A - Bedlight Switch - 2 Way - 2X1 - 2 Module | 778 | 1/5/50 |
|------------------|--|-----|--------|

|                  |  |     |        |
|------------------|--|-----|--------|
| <b>AC23119MW</b> | 10A - Push for Bedlight - 2 Way - 2X1 - 2 Module | 778 | 1/5/50 |
|------------------|--|-----|--------|

#### Reading Light

|                |                              |      |      |
|----------------|------------------------------|------|------|
| <b>AC657MW</b> | Reading Light LED - 2 Module | 4188 | 1/12 |
|----------------|------------------------------|------|------|

## Protectors & Accessories

| Cat.Nos | Description | MRP*<br>₹ / Unit | Pack |
|---------|-------------|------------------|------|
|---------|-------------|------------------|------|

#### Surge Protector

|                |                            |      |        |
|----------------|----------------------------|------|--------|
| <b>AC627MW</b> | Surge Protector - 1 Module | 6692 | 20/200 |
|----------------|----------------------------|------|--------|

#### Motor Starter

|                  |                                |      |          |
|------------------|--------------------------------|------|----------|
| <b>AC20111MW</b> | 16A - Motor Starter - 2 Module | 1332 | 1/10/100 |
|------------------|--------------------------------|------|----------|

|                  |                                |      |          |
|------------------|--------------------------------|------|----------|
| <b>AC20112MW</b> | 25A - Motor Starter - 2 Module | 1368 | 1/10/100 |
|------------------|--------------------------------|------|----------|

#### Modular MCB

|                |   |     |        |
|----------------|---|-----|--------|
| <b>AC628MW</b> | 16A - SP - Modular MCB - C Curve - 1 Module | 796 | 1/5/50 |
|----------------|---|-----|--------|

\* MRP - Maximum Retail Price Inclusive of all taxes including GST.  
Red Cat. Nos - New Products

Bold Cat.Nos are products normally available with Legrand (India) Stockists. Cat.Nos that are not bold - delivery within 4 - 8 weeks from the date of order. Bold packing quantity is our mandatory packing. Orders to be placed by Legrand (India) Stockist in multiples of the same.

## Arteor Advance™

**NEW!**

### Protectors & Accessories

| Cat.Nos            | Description                                 | MRP*<br>₹ / Unit | Pack   |
|--------------------|---|------------------|--------|
| <b>Modular MCB</b> |   |                  |        |
| <b>AC625MW</b>     | 20A - SP - Modular MCB - C Curve - 1 Module | 796              | 1/5/50 |
| <b>AC626MW</b>     | 32A - SP - Modular MCB - C Curve - 1 Module | 796              | 1/5/50 |



AC626MW

### Audio-Video Sockets

|                 |  |       |          |
|-----------------|--|-------|----------|
| <b>AC4430MW</b> | Female 3.5mm Jack - 1 Module                 | 6684  | 1/10     |
| <b>AC4421MW</b> | Preterminated Sockets Female Hd15 - 1 Module | 9306  | 1/10     |
| <b>AC4411MW</b> | Preterminated HDMI Socket - 1.4 - 1 Module   | 11044 | 1/10     |
| <b>AC4400MW</b> | Loudspeaker Socket - 1 Module                | 1180  | 1/10/100 |
| <b>AC4452MW</b> | Male XLR Jack - 2 Module                     | 9484  | 1/20     |
| <b>AC4412MW</b> | Preterminated HDMI Socket - 1.4 - 2 Module   | 11598 | 1/10     |
| <b>AC4106MW</b> | TV-R-SAT Socket - 2 Module                   | 5706  | 1/0/10   |
| <b>AC4442MW</b> | Triple RCA Socket (Audio & Video) - 1 Module | 6022  | 1/20     |
| <b>AC4362MW</b> | Preterminated USB Data Socket - 1 Module     | 8322  | 1/10     |
| <b>AC4360MW</b> | USB Socket - 1 Module                        | 5268  | 2/0/20   |
| <b>AC4470MW</b> | Line Dying Down - 100V (25 - 30W) - 2 Module | 17522 | 1/20     |
| <b>AC4450MW</b> | Female XLR Jack - 2 Module                   | 10516 | 1/20     |
| <b>AC4440MW</b> | 2 Female RCA Socket - 1 Module               | 4888  | 1/10     |



AC4430MW



AC4411MW



AC4400MW



AC4452MW



AC4362MW



AC4470MW



AC4450MW

## Arteor Advance™

**NEW!**

### Protectors & Accessories

| Cat.Nos             | Description                                | MRP*<br>₹ / Unit | Pack   |
|---------------------|--|------------------|--------|
| <b>Cable Outlet</b> |  |                  |        |
| <b>AC350MW</b>      | 20A - Cable Outlet - 2 Module              | 1810             | 10/100 |
| <b>AC354MW</b>      | Cord Outlet - with 8mm Diameter - 1 Module | 576              | 20/200 |



AC350MW

### Blanking Plate

|                |                           |     |          |
|----------------|---------------------------|-----|----------|
| <b>AC150MW</b> | Blanking Plate - 1 Module | 82  | 1/40/400 |
| <b>AC153MW</b> | Blanking Plate - 2 Module | 122 | 1/10/100 |



AC153MW

### Mounting Accessories for Panel

|              |                                   |     |        |
|--------------|-----------------------------------|-----|--------|
| <b>A1401</b> | Panel Mounting Support - 2 Module | 500 | 10/100 |
|--------------|-----------------------------------|-----|--------|



A1401

## Classic - Matt Black Mechanisms

| Cat.Nos                         | Description                                      | MRP*<br>₹ / Unit | Pack     |
|---------------------------------|--|------------------|----------|
| <b>Switches - 10A - 230V AC</b> |  |                  |          |
| <b>AC21104MB</b>                | 10A - Switch - 1 Way - 1 Module                  | 306              | 1/20/200 |
| <b>AC21106MB</b>                | 10A - Switch - 1 Way - with Indicator - 1 Module | 558              | 1/20/200 |
| <b>AC21105MB</b>                | 10A - Switch - 1 Way - with Locator - 1 Module   | 558              | 1/20/200 |
| <b>AC22105MB</b>                | 10A - Switch - 2 Way - 1 Module                  | 500              | 1/20/200 |
| <b>AC22107MB</b>                | 10A - Switch - 2 Way - with Indicator - 1 Module | 714              | 1/20/200 |
| <b>AC21119MB</b>                | 10A - Switch - 1 Way - with Indicator - 2 Module | 632              | 1/10/100 |



AC21104MB



AC22105MB



AC21119MB

### Switches - 16A - 230V AC

|                  |  |      |          |
|------------------|--|------|----------|
| <b>AC21101MB</b> | 16A - Switch - 1 Way - 1 Module                  | 512  | 1/20/200 |
| <b>AC21118MB</b> | 16A - Switch - 1 Way - with Indicator - 1 Module | 640  | 1/20/200 |
| <b>AC22101MB</b> | 16A - Switch - 2 Way - 1 Module                  | 800  | 1/20/200 |
| <b>AC22102MB</b> | 16A - Switch - 2 Way - with Indicator - 1 Module | 818  | 1/20/200 |
| <b>AC21103MB</b> | 16A - Switch - 1 Way - 2 Module                  | 632  | 1/10/100 |
| <b>AC20109MB</b> | 16A - Intermediate Switch - 230V AC - 2 Module   | 3970 | 10/100   |
| <b>AC22109MB</b> | 16A - Switch - 2 Way - 2 Module                  | 1036 | 1/10/100 |



AC21101MB



AC22102MB



AC22109MB

\* MRP - Maximum Retail Price Inclusive of all taxes including GST.  
Red Cat. Nos - New Products

Bold Cat.Nos are products normally available with Legrand (India) Stockists. Cat.Nos that are not bold - delivery within 4 - 8 weeks from the date of order. Bold packing quantity is our mandatory packing. Orders to be placed by Legrand (India) Stockist in multiples of the same.

## Arteor Advance™

**NEW!** Classic - Matt Black Mechanisms

| Cat.Nos                         | Description  | MRP*<br>₹ / Unit | Pack     |
|---------------------------------|--|------------------|----------|
| <b>Switches – 20A - 230V AC</b> |  |                  |          |
| <b>AC21107MB</b>                | 20A - Switch - 1 Way - 1 Module  | 664              | 1/20/200 |
| <b>AC21108MB</b>                | 20A - Switch - 1 Way - with Indicator - 1 Module                             | 768              | 1/20/200 |
| <b>AC22106MB</b>                | 20A - Switch - 2 Way - 1 Module  | 862              | 1/20/200 |
| <b>AC22108MB</b>                | 20A - Switch - 2 Way - with Indicator - 1 Module                             | 958              | 1/20/200 |
| <b>AC21112MB</b>                | 20A - Switch - 1 Way - 2 Module  | 784              | 1/10/100 |
| <b>AC22119MB</b>                | 20A - Switch - 2 Way - 2 Module  | 924              | 1/10/100 |
| <b>AC22113MB</b>                | 20A - Switch - SP - 2 Way - with Indicator - 2 Module                        | 1030             | 1/10/100 |
| <b>AC21312MB</b>                | 20A - Switch - 3 Gang - 1 Way - 2 Module                                     | 1894             | 1/10/100 |
| <b>AC29101MB</b>                | 20A - Switch - 3 Gang - 2X2 Way + 1X1 Way - 2 Module                         | 1984             | 1/10/100 |
| <b>AC21113MB</b>                | 20A - Switch - DP - 1 Way - with Indicator - 2 Module                        | 1534             | 1/10/100 |
| <b>AC20105MB</b>                | 20A - Switch - DP - 1 Way - with Indicator & Water Heater Marking - 2 Module | 1640             | 1/10/100 |

### Switches – 25A - 230V AC

|                  |  |     |          |
|------------------|--|-----|----------|
| <b>AC21115MB</b> | 25A - Switch - 1 Way - with Indicator - 1 Module | 880 | 1/20/200 |
|------------------|--|-----|----------|

### Switches – 32A - 230V AC

|                  |   |      |          |
|------------------|---|------|----------|
| <b>AC20101MB</b> | 32A - Switch - DP - 1 Way - with Indicator - 2 Module | 2140 | 1/10/100 |
|------------------|---|------|----------|

### Push Button – 10A - 230V AC

|                  |   |     |          |
|------------------|---|-----|----------|
| <b>AC23102MB</b> | 10A - Bell Push - 1 Way - 1 Module                | 544 | 1/20/200 |
| <b>AC23103MB</b> | 10A - Bell Push - 1 Way - with Locator - 1 Module | 752 | 1/20/200 |

## Arteor Advance™

**NEW!** Classic - Matt Black Mechanisms

| Cat.Nos                            | Description   | MRP*<br>₹ / Unit | Pack     |
|------------------------------------|---|------------------|----------|
| <b>Push Button – 10A - 230V AC</b> |   |                  |          |
| <b>AC23111MB</b>                   | 10A - Bell Push - 1 Way - 2 Module                  | 778              | 1/10/100 |
| <b>AC23112MB</b>                   | 10A - Bell Push - 1 Way - with Locator - 2 Module   | 1048             | 1/10/100 |
| <b>AC23106MB</b>                   | 10A - Push Button - 1 Way - 1 Module                | 566              | 1/20/200 |
| <b>AC23107MB</b>                   | 10A - Push Button - 1 Way - with Locator - 1 Module | 754              | 1/20/200 |
| <b>AC23108MB</b>                   | 10A - Push Button - 2 Way - 1 Module                | 830              | 1/5/50   |

### Electric Roller Blinds

|                  |   |      |          |
|------------------|---|------|----------|
| <b>AC26104MB</b> | Double Switch for Electric Shutter - 2 Module | 1376 | 1/10/100 |
|------------------|---|------|----------|

### Dimmers and Fan Regulators

|                  |   |       |          |
|------------------|---|-------|----------|
| <b>AC24103MB</b> | Light Dimmer - 60 to 400 Watts - 2 Module           | 2304  | 1/10/100 |
| <b>AC24105MB</b> | Push Dimmer 0-10V - 2 Module                        | 13324 | 1/20     |
| <b>AC24101MB</b> | Push Dimmer 150W With Neutral - 1 Module            | 19032 | 1/5/20   |
| <b>AC24104MB</b> | Push Dimmer 125W Without Neutral - 2 Module         | 12372 | 1/20     |
| <b>AC24106MB</b> | Touch Dimmer 5-300W/75W - 2 Module                  | 11882 | 1/20     |
| <b>AC24107MB</b> | Rotary Dimmer 200W LED - 2 Module                   | 21782 | 1/10     |
| <b>AC661MB</b>   | Fan Step Regulator - 100 Watts - ISI - 1 Module     | 1848  | 1/5/50   |
| <b>AC662MB</b>   | Fan Step Regulator - 100 Watts - ISI - 2 Module     | 2280  | 1/10/100 |
| <b>AC665MB</b>   | Fan Step Regulator - 70 Watts - ISI - 2 Module      | 2420  | 1/10/100 |
| <b>AC663MB</b>   | Fan Step Regulator - 120 Watts - ISI - 2 Module     | 2440  | 1/10/100 |
| <b>AC664MB</b>   | Fan Regulator - 8 Step - 100 Watts - ISI - 2 Module | 2164  | 1/10/100 |

\* MRP - Maximum Retail Price Inclusive of all taxes including GST.  
Red Cat. Nos - New Products

Bold Cat.Nos are products normally available with Legrand (India) Stockists. Cat.Nos that are not bold - delivery within 4 - 8 weeks from the date of order. Bold packing quantity is our mandatory packing. Orders to be placed by Legrand (India) Stockist in multiples of the same.

## Arteor Advance™

**NEW!**

### Classic - Matt Black Mechanisms

| Cat.Nos                        | Description   | MRP*<br>₹ / Unit | Pack     |
|--------------------------------|---|------------------|----------|
| <b>Indian Standard Sockets</b> |   |                  |          |
| <b>AC3163MB</b>                | 6A - Socket - with Shutter - 3 Pin - ISI - 2 Module             | 472              | 1/20/200 |
| <b>AC3166MB</b>                | 6/16A - Socket - with Shutter - 3 Pin - Indian - ISI - 2 Module | 922              | 1/10/100 |
| <b>AC3167MB</b>                | 6/16A - Socket - with Shutter - 3 Pin - Indian - ISI - 3 Module | 1122             | 1/5/50   |

### USB Chargers

|                 |   |       |          |
|-----------------|---|-------|----------|
| <b>AC3408MB</b> | USB Charger - 3000mA/15 Watts - Type A - 1 Module               | 4042  | 1/10/150 |
| <b>AC3410MB</b> | USB Charger - 3000mA/15 Watts - Type A + A - 1 Module           | 4610  | 1/10/150 |
| <b>AC3411MB</b> | USB Charger - 3000mA/15 Watts - Type A + C - 1 Module           | 5288  | 1/10/150 |
| <b>AC3412MB</b> | USB Charger - 3000mA/15 Watts - Type C + C - 1 Module           | 5778  | 1/10/150 |
| <b>AC3409MB</b> | USB Charger - Power Delivery - 20 Watts - Type C - 1 Module     | 7596  | 1/10/150 |
| <b>AC3406MB</b> | USB Charger - Power Delivery - 30 Watts - Type C + C - 2 Module | 11096 | 1/20     |
| <b>AC3401MB</b> | USB Charger - Power Delivery - 45 Watts - Type C - 2 Module     | 14322 | 1/20     |
| <b>AC3415MB</b> | USB Charger - Power Delivery - 65 Watts - Type C + C - 3 Module | 17542 | 1/20     |

### Data and Voice

|                 |  |      |          |
|-----------------|--|------|----------|
| <b>AC423MB</b>  | Telephone Socket - Double RJ11 - 1 Module                        | 860  | 1/20/200 |
| <b>AC424MB</b>  | Telephone Socket - RJ11 - with Shutter - 1 Module                | 520  | 1/20/200 |
| <b>AC4306MB</b> | Information Socket - RJ45 - Cat 6A - UTP - 1 Module              | 2346 | 10/100   |
| <b>AC4315MB</b> | Information Socket - RJ45 Rear Pluggable - CAT6 - UTP - 2 Module | 5824 | 1/10/100 |

### TV Sockets

|                 |                                 |     |          |
|-----------------|---------------------------------|-----|----------|
| <b>AC4110MB</b> | TV Co - axial Socket - 1 Module | 524 | 1/20/200 |
|-----------------|---------------------------------|-----|----------|

## Arteor Advance™

**NEW!**

### Classic - Matt Black Mechanisms

| Cat.Nos | Description | MRP*<br>₹ / Unit | Pack |
|---------|-------------|------------------|------|
|---------|-------------|------------------|------|

### Electronic Chime

|                |                                  |     |          |
|----------------|----------------------------------|-----|----------|
| <b>AC618MB</b> | Bell Ding Dong - 230V - 2 Module | 856 | 1/10/100 |
|----------------|----------------------------------|-----|----------|

### Buzzer

|                |                          |      |       |
|----------------|--------------------------|------|-------|
| <b>AC615MB</b> | Buzzer - 230V - 1 Module | 2318 | 10/60 |
|----------------|--------------------------|------|-------|

### Bell Call Indicator

|                  |                                |      |          |
|------------------|--------------------------------|------|----------|
| <b>AC23105MB</b> | Bell Call Indicator - 1 Module | 3534 | 1/20/200 |
|------------------|--------------------------------|------|----------|

### Infrared Sensors

|                  |  |       |      |
|------------------|--|-------|------|
| <b>AC25102MB</b> | IR Motion Sensor with Neutral - 2 Module | 14862 | 1/20 |
|------------------|--|-------|------|

### Innovative Switch

|                  |   |      |      |
|------------------|---|------|------|
| <b>AC28102MB</b> | Contactless Door Switch - 12-24-48 V - 2 Module | 8586 | 1/20 |
| <b>AC28101MB</b> | Contactless Light Switch - 230V AC - 2 Module   | 7728 | 1/20 |

### Skirting Light

|                |   |      |        |
|----------------|---|------|--------|
| <b>AC653MB</b> | Skirting Light - with LED - 230V - 3 Module | 1900 | 10/100 |
|----------------|---|------|--------|

## Protectors & Accessories

| Cat.Nos | Description | MRP*<br>₹ / Unit | Pack |
|---------|-------------|------------------|------|
|---------|-------------|------------------|------|

### Hotel "DND and MMR" functions

|                  |   |      |          |
|------------------|---|------|----------|
| <b>AC27107MB</b> | Interlocked Internal DND & MMR Control Unit - 2 Module      | 2734 | 1/10/100 |
| <b>AC27108MB</b> | External DND & MMR Control Unit - with Bell Push - 2 Module | 3778 | 1/5/50   |

### Hotel Keycard Switch

|                  |   |       |      |
|------------------|---|-------|------|
| <b>AC27110MB</b> | 16A - Key Card Switch - 230V - 2 Module           | 9908  | 1/20 |
| <b>AC27111MB</b> | 16A - Key Card Switch with RFID - 230V - 2 Module | 10336 | 1/20 |

### Shaver Socket

|                |  |       |      |
|----------------|--|-------|------|
| <b>AC361MB</b> | Shaver Socket - 230V/120 - 230V - with Earth Connector | 10302 | 1/10 |
|----------------|--|-------|------|

### Time Switch

|                  |                              |       |      |
|------------------|------------------------------|-------|------|
| <b>AC20110MB</b> | Time Delay Switch - 2 Module | 12220 | 1/20 |
|------------------|------------------------------|-------|------|

\* MRP - Maximum Retail Price Inclusive of all taxes including GST.  
Red Cat. Nos - New Products

Bold Cat.Nos are products normally available with Legrand (India) Stockists. Cat.Nos that are not bold - delivery within 4 - 8 weeks from the date of order. Bold packing quantity is our mandatory packing. Orders to be placed by Legrand (India) Stockist in multiples of the same.

## Arteor Advance™

**NEW!** Hospitality Function

| Cat.Nos | Description | MRP*<br>₹ / Unit | Pack |
|---------|-------------|------------------|------|
|---------|-------------|------------------|------|

### Master Switch

|                  |  |     |          |
|------------------|--|-----|----------|
| <b>AC22114MB</b> | 20A - Master Switch - DP - 2 Way - ON/OFF - 2 Module | 948 | 1/10/100 |
| <b>AC23115MB</b> | Master Push ON/OFF - 2 Way - 2 Module                | 908 | 1/10/100 |

### Bedlight Switch

|                  |  |     |        |
|------------------|--|-----|--------|
| <b>AC21117MB</b> | 10A - Bedlight Switch - 2 Way - 2X1 - 2 Module   | 908 | 1/5/50 |
| <b>AC23119MB</b> | 10A - Push for Bedlight - 2 Way - 2X1 - 2 Module | 908 | 1/5/50 |

### Reading Light

|                |                              |      |      |
|----------------|------------------------------|------|------|
| <b>AC657MB</b> | Reading Light LED - 2 Module | 4348 | 1/12 |
|----------------|------------------------------|------|------|

## Protectors & Accessories

### Surge Protector

|                |                            |      |        |
|----------------|----------------------------|------|--------|
| <b>AC627MB</b> | Surge Protector - 1 Module | 7364 | 20/200 |
|----------------|----------------------------|------|--------|

### Motor Starter

|                  |                                |      |          |
|------------------|--------------------------------|------|----------|
| <b>AC20111MB</b> | 16A - Motor Starter - 2 Module | 1566 | 1/10/100 |
| <b>AC20112MB</b> | 25A - Motor Starter - 2 Module | 1604 | 1/10/100 |

### Modular MCB

|                |   |     |        |
|----------------|---|-----|--------|
| <b>AC628MB</b> | 16A - SP - Modular MCB - C Curve - 1 Module | 916 | 1/5/50 |
| <b>AC625MB</b> | 20A - SP - Modular MCB - C Curve - 1 Module | 916 | 1/5/50 |
| <b>AC626MB</b> | 32A - SP - Modular MCB - C Curve - 1 Module | 916 | 1/5/50 |

### Audio-Video Sockets

|                 |  |       |          |
|-----------------|--|-------|----------|
| <b>AC4430MB</b> | Female 3.5mm Jack - 1 Module                 | 7424  | 1/10     |
| <b>AC4421MB</b> | Preterminated Sockets Female Hd15 - 1 Module | 10240 | 1/10     |
| <b>AC4411MB</b> | Preterminated HDMI Socket - 1.4 - 1 Module   | 11604 | 1/10     |
| <b>AC4400MB</b> | Loudspeaker Socket - 1 Module                | 1300  | 1/10/100 |
| <b>AC4452MB</b> | Male XLR Jack - 2 Module                     | 10954 | 1/20     |
| <b>AC4412MB</b> | Preterminated HDMI Socket - 1.4 - 2 Module   | 12188 | 1/10     |
| <b>AC4106MB</b> | TV-R-SAT Socket - 2 Module                   | 6582  | 1/0/10   |

\* MRP - Maximum Retail Price Inclusive of all taxes including GST.  
Red Cat. Nos - New Products

## Arteor Advance™

**NEW!** Protectors & Accessories

| Cat.Nos | Description | MRP*<br>₹ / Unit | Pack |
|---------|-------------|------------------|------|
|---------|-------------|------------------|------|

### Audio-Video Sockets

|                 |  |       |        |
|-----------------|--|-------|--------|
| <b>AC4442MB</b> | Triple RCA Socket (Audio & Video) - 1 Module | 6526  | 1/20   |
| <b>AC4362MB</b> | Preterminated USB Data Socket - 1 Module     | 8754  | 1/10   |
| <b>AC4360MB</b> | USB Socket - 1 Module                        | 5882  | 2/0/20 |
| <b>AC4470MB</b> | Line Dying Down - 100V (25 - 30W) - 2 Module | 20912 | 1/20   |
| <b>AC4450MB</b> | Female XLR Jack - 2 Module                   | 13178 | 1/20   |
| <b>AC4440MB</b> | 2 Female RCA Socket - 1 Module               | 5318  | 1/10   |

### Cable Outlet

|                |  |     |        |
|----------------|--|-----|--------|
| <b>AC354MB</b> | Cord Outlet - with 8mm Diameter - 1 Module | 638 | 20/200 |
|----------------|--|-----|--------|

### Blanking Plate

|                |                           |     |          |
|----------------|---------------------------|-----|----------|
| <b>AC150MB</b> | Blanking Plate - 1 Module | 80  | 1/40/400 |
| <b>AC153MB</b> | Blanking Plate - 2 Module | 138 | 1/10/100 |

## Classic - Matt Titanium Mechanisms

### Switches - 10A - 230V AC

|                  |  |     |          |
|------------------|--|-----|----------|
| <b>AC21104MT</b> | 10A - Switch - 1 Way - 1 Module                  | 306 | 1/20/200 |
| <b>AC21106MT</b> | 10A - Switch - 1 Way - with Indicator - 1 Module | 558 | 1/20/200 |
| <b>AC21105MT</b> | 10A - Switch - 1 Way - with Locator - 1 Module   | 558 | 1/20/200 |
| <b>AC22105MT</b> | 10A - Switch - 2 Way - 1 Module                  | 500 | 1/20/200 |
| <b>AC22107MT</b> | 10A - Switch - 2 Way - with Indicator - 1 Module | 714 | 1/20/200 |
| <b>AC21119MT</b> | 10A - Switch - 1 Way - with Indicator - 2 Module | 632 | 1/10/100 |

Bold Cat.Nos are products normally available with Legrand (India) Stockists. Cat.Nos that are not bold - delivery within 4 - 8 weeks from the date of order. Bold packing quantity is our mandatory packing. Orders to be placed by Legrand (India) Stockist in multiples of the same.

## Arteor Advance™

**NEW!**

### Classic - Matt Titanium Mechanisms

| Cat.Nos                         | Description                                      | MRP*<br>₹ / Unit | Pack     |
|---------------------------------|--|------------------|----------|
| <b>Switches – 16A - 230V AC</b> |  |                  |          |
| <b>AC21101MT</b>                | 16A - Switch - 1 Way - 1 Module                  | 512              | 20/200   |
| <b>AC21118MT</b>                | 16A - Switch - 1 Way - with Indicator - 1 Module | 640              | 1/20/200 |
| <b>AC222101MT</b>               | 16A - Switch - 2 Way - 1 Module                  | 800              | 1/20/200 |
| <b>AC222102MT</b>               | 16A - Switch - 2 Way - with Indicator - 1 Module | 818              | 1/20/200 |
| <b>AC21103MT</b>                | 16A - Switch - 1 Way - 2 Module                  | 632              | 1/10/100 |
| <b>AC20109MT</b>                | 16A - Intermediate Switch - 230V AC - 2 Module   | 3970             | 1/10/100 |
| <b>AC222109MT</b>               | 16A - Switch - 2 Way - 2 Module                  | 1036             | 1/10/100 |

### Switches – 20A - 230V AC

|                   |  |      |          |
|-------------------|--|------|----------|
| <b>AC21107MT</b>  | 20A - Switch - 1 Way - 1 Module  | 664  | 1/20/200 |
| <b>AC21108MT</b>  | 20A - Switch - 1 Way - with Indicator - 1 Module                             | 768  | 1/20/200 |
| <b>AC222106MT</b> | 20A - Switch - 2 Way - 1 Module  | 862  | 1/20/200 |
| <b>AC222108MT</b> | 20A - Switch - 2 Way - with Indicator - 1 Module                             | 958  | 1/20/200 |
| <b>AC21112MT</b>  | 20A - Switch - 1 Way - 2 Module  | 784  | 1/10/100 |
| <b>AC222119MT</b> | 20A - Switch - 2 Way - 2 Module  | 924  | 1/10/100 |
| <b>AC222113MT</b> | 20A - Switch - 2 Way - with Indicator - 2 Module                             | 1030 | 1/10/100 |
| <b>AC21312MT</b>  | 20A - Switch - 3 Gang - 1 Way - 2 Module                                     | 1894 | 1/10/100 |
| <b>AC29101MT</b>  | 20A - Switch - 3 Gang - 2X2 Way + 1X1 Way - 2 Module                         | 1984 | 1/10/100 |
| <b>AC21113MT</b>  | 20A - Switch - DP - 1 Way - with Indicator - 2 Module                        | 1534 | 1/10/100 |
| <b>AC20105MT</b>  | 20A - Switch - DP - 1 Way - with Indicator & Water Heater Marking - 2 Module | 1640 | 1/10/100 |

\* MRP - Maximum Retail Price Inclusive of all taxes including GST.  
Red Cat. Nos - New Products

## Arteor Advance™

**NEW!**

### Classic - Matt Titanium Mechanisms

| Cat.Nos                            | Description   | MRP*<br>₹ / Unit | Pack     |
|------------------------------------|---|------------------|----------|
| <b>Switches – 25A - 230V AC</b>    |   |                  |          |
| <b>AC21115MT</b>                   | 25A - Switch - 1 Way - with Indicator - 1 Module      | 880              | 1/20/200 |
| <b>Switches – 32A - 230V AC</b>    |   |                  |          |
| <b>AC20101MT</b>                   | 32A - Switch - DP - 1 Way - with Indicator - 2 Module | 2140             | 1/10/100 |
| <b>Push Button – 10A - 230V AC</b> |   |                  |          |
| <b>AC23102MT</b>                   | 10A - Bell Push - 1 Way - 1 Module                    | 544              | 1/20/200 |
| <b>AC23103MT</b>                   | 10A - Bell Push - 1 Way - with Locator - 1 Module     | 752              | 1/20/200 |
| <b>AC23111MT</b>                   | 10A - Bell Push - 1 Way - 2 Module                    | 778              | 1/10/100 |
| <b>AC23112MT</b>                   | 10A - Bell Push - 1 Way - with Locator - 2 Module     | 1048             | 1/10/100 |
| <b>AC23106MT</b>                   | 10A - Push Button - 1 Way - 1 Module                  | 566              | 1/20/200 |
| <b>AC23107MT</b>                   | 10A - Push Button - 1 Way - with Locator - 1 Module   | 754              | 1/20/200 |
| <b>AC23108MT</b>                   | 10A - Push Button - 2 Way - 1 Module                  | 830              | 1/5/50   |

### Electric Roller Blinds

|                  |   |      |          |
|------------------|---|------|----------|
| <b>AC26104MT</b> | Double Switch for Electric Shutter - 2 Module | 1432 | 1/10/100 |
|------------------|---|------|----------|

### Dimmers and Fan Regulators

|                  |   |       |          |
|------------------|---|-------|----------|
| <b>AC24103MT</b> | Light Dimmer - 60 to 400 Watts - 2 Module           | 2304  | 1/10/100 |
| <b>AC24105MT</b> | Push Dimmer 0-10V - 2 Module                        | 13862 | 1/20     |
| <b>AC24101MT</b> | Push Dimmer 150W With Neutral - 1 Module            | 19802 | 1/5/20   |
| <b>AC24104MT</b> | Push Dimmer 125W Without Neutral - 2 Module         | 12872 | 1/20     |
| <b>AC24106MT</b> | Touch Dimmer 5-300W/75W - 2 Module                  | 11882 | 1/20     |
| <b>AC24107MT</b> | Rotary Dimmer 200W LED - 2 Module                   | 21782 | 1/10     |
| <b>AC661MT</b>   | Fan Step Regulator - 100 Watts - ISI - 1 Module     | 1848  | 1/5/50   |
| <b>AC662MT</b>   | Fan Step Regulator - 100 Watts - ISI - 2 Module     | 2280  | 1/10/100 |
| <b>AC665MT</b>   | Fan Step Regulator - 70 Watts - ISI - 2 Module      | 2420  | 1/10/100 |
| <b>AC663MT</b>   | Fan Step Regulator - 120 Watts - ISI - 2 Module     | 2440  | 1/10/100 |
| <b>AC664MT</b>   | Fan Regulator - 8 Step - 100 Watts - ISI - 2 Module | 2164  | 1/10/100 |

Bold Cat.Nos are products normally available with Legrand (India) Stockists. Cat.Nos that are not bold - delivery within 4 - 8 weeks from the date of order. Bold packing quantity is our mandatory packing. Orders to be placed by Legrand (India) Stockist in multiples of the same.

## Arteor Advance™

**NEW!** Classic - Matt Titanium Mechanisms

| Cat.Nos                        | Description   | MRP*<br>₹ / Unit | Pack     |
|--------------------------------|---|------------------|----------|
| <b>Indian Standard Sockets</b> |   |                  |          |
| <b>AC3163MT</b>                | 6A - Socket - with Shutter - 3 Pin - ISI - 2 Module             | 472              | 1/20/200 |
| <b>AC3166MT</b>                | 6/16A - Socket - with Shutter - 3 Pin - Indian - ISI - 2 Module | 922              | 1/10/100 |
| <b>AC3167MT</b>                | 6/16A - Socket - with Shutter - 3 Pin - Indian - ISI - 3 Module | 1122             | 1/5/50   |

### USB Chargers

|                 |   |       |          |
|-----------------|---|-------|----------|
| <b>AC3408MT</b> | USB Charger - 3000mA/15 Watts - Type A - 1 Module               | 4042  | 1/10/150 |
| <b>AC3410MT</b> | USB Charger - 3000mA/15 Watts - Type A + A - 1 Module           | 4610  | 1/10/150 |
| <b>AC3411MT</b> | USB Charger - 3000mA/15 Watts - Type A + C - 1 Module           | 5288  | 1/10/150 |
| <b>AC3412MT</b> | USB Charger - 3000mA/15 Watts - Type C + C - 1 Module           | 5778  | 1/10/150 |
| <b>AC3409MT</b> | USB Charger - Power Delivery - 20 Watts - Type C - 1 Module     | 7596  | 1/10/150 |
| <b>AC3406MT</b> | USB Charger - Power Delivery - 30 Watts - Type C + C - 2 Module | 11096 | 1/20     |
| <b>AC3401MT</b> | USB Charger - Power Delivery - 45 Watts - Type C - 2 Module     | 14322 | 1/20     |
| <b>AC3415MT</b> | USB Charger - Power Delivery - 65 Watts - Type C + C - 3 Module | 17542 | 1/20     |

### Data and Voice

|                 |  |      |          |
|-----------------|--|------|----------|
| <b>AC423MT</b>  | Telephone Socket - Double RJ11 - 1 Module                        | 860  | 1/20/200 |
| <b>AC424MT</b>  | Telephone Socket - RJ11 - with Shutter - 1 Module                | 520  | 1/20/200 |
| <b>AC4306MT</b> | Information Socket - RJ45 - Cat 6A - UTP - 1 Module              | 2346 | 10/100   |
| <b>AC4315MT</b> | Information Socket - RJ45 Rear Pluggable - CAT6 - UTP - 2 Module | 5824 | 1/10/100 |

### TV Sockets

|                 |                                 |     |          |
|-----------------|---------------------------------|-----|----------|
| <b>AC4110MT</b> | TV Co - axial Socket - 1 Module | 524 | 1/20/200 |
|-----------------|---------------------------------|-----|----------|

## Arteor Advance™

**NEW!** Classic - Matt Titanium Mechanisms

| Cat.Nos | Description | MRP*<br>₹ / Unit | Pack |
|---------|-------------|------------------|------|
|---------|-------------|------------------|------|

### Electronic Chime

|                |                                  |     |          |
|----------------|----------------------------------|-----|----------|
| <b>AC618MT</b> | Bell Ding Dong - 230V - 2 Module | 856 | 1/10/100 |
|----------------|----------------------------------|-----|----------|

### Buzzer

|                |                          |      |       |
|----------------|--------------------------|------|-------|
| <b>AC615MT</b> | Buzzer - 230V - 1 Module | 2318 | 10/60 |
|----------------|--------------------------|------|-------|

### Bell Call Indicator

|                  |                                |      |          |
|------------------|--------------------------------|------|----------|
| <b>AC23105MT</b> | Bell Call Indicator - 1 Module | 3534 | 1/20/200 |
|------------------|--------------------------------|------|----------|

### Infrared Sensors

|                  |  |       |      |
|------------------|--|-------|------|
| <b>AC25102MT</b> | IR Motion Sensor with Neutral - 2 Module | 14862 | 1/20 |
|------------------|--|-------|------|

### Innovative Switch

|                  |   |      |      |
|------------------|---|------|------|
| <b>AC28102MT</b> | Contactless Door Switch - 12-24-48 V - 2 Module | 8586 | 1/20 |
| <b>AC28101MT</b> | Contactless Light Switch - 230V AC - 2 Module   | 7728 | 1/20 |

### Skirting Light

|                |   |      |        |
|----------------|---|------|--------|
| <b>AC653MT</b> | Skirting Light - with LED - 230V - 3 Module | 1900 | 10/100 |
|----------------|---|------|--------|

## Hospitality Function

### Hotel "DND and MMR" functions

|                  |   |      |          |
|------------------|---|------|----------|
| <b>AC27107MT</b> | Interlocked Internal DND & MMR Control Unit - 2 Module      | 2734 | 1/10/100 |
| <b>AC27108MT</b> | External DND & MMR Control Unit - with Bell Push - 2 Module | 3778 | 1/5/50   |

### Hotel Keycard Switch

|                  |   |       |      |
|------------------|---|-------|------|
| <b>AC27110MT</b> | 16A - Key Card Switch - 230V - 2 Module           | 9908  | 1/20 |
| <b>AC27111MT</b> | 16A - Key Card Switch with RFID - 230V - 2 Module | 10336 | 1/20 |

### Shaver Socket

|                |  |       |      |
|----------------|--|-------|------|
| <b>AC361MT</b> | Shaver Socket - 230V/120 - 230V - with Earth Connector | 10302 | 1/10 |
|----------------|--|-------|------|

### Time Switch

|                  |                              |       |      |
|------------------|------------------------------|-------|------|
| <b>AC20110MT</b> | Time Delay Switch - 2 Module | 12220 | 1/20 |
|------------------|------------------------------|-------|------|

\* MRP - Maximum Retail Price Inclusive of all taxes including GST.  
Red Cat. Nos - New Products

Bold Cat.Nos are products normally available with Legrand (India) Stockists. Cat.Nos that are not bold - delivery within 4 - 8 weeks from the date of order. Bold packing quantity is our mandatory packing. Orders to be placed by Legrand (India) Stockist in multiples of the same.

## Arteor Advance™

**NEW!**

### Hospitality Function

| Cat.Nos | Description | MRP*<br>₹ / Unit | Pack |
|---------|-------------|------------------|------|
|---------|-------------|------------------|------|

#### Master Switch

|                  |  |     |          |
|------------------|--|-----|----------|
| <b>AC22114MT</b> | 20A - Master Switch - DP - 2 Way - ON/OFF - 2 Module | 948 | 1/10/100 |
| <b>AC23115MT</b> | Master Push ON/OFF - 2 Way - 2 Module                | 908 | 1/10/100 |



AC22114MT

#### Bedlight Switch

|                  |  |     |        |
|------------------|--|-----|--------|
| <b>AC21117MT</b> | 10A - Bedlight Switch - 2 Way - 2X1 2 Module   | 908 | 1/5/50 |
| <b>AC23119MT</b> | 10A - Push for Bedlight - 2 Way - 2X1 2 Module | 908 | 1/5/50 |



AC21117MT

## Arteor Advance™

### Protectors & Accessories

#### Surge Protector

|                |                            |      |        |
|----------------|----------------------------|------|--------|
| <b>AC627MT</b> | Surge Protector - 1 Module | 7364 | 20/200 |
|----------------|----------------------------|------|--------|



AC627MT

#### Motor Starter

|                  |                                |      |          |
|------------------|--------------------------------|------|----------|
| <b>AC20111MT</b> | 16A - Motor Starter - 2 Module | 1566 | 1/10/100 |
| <b>AC20112MT</b> | 25A - Motor Starter - 2 Module | 1604 | 1/10/100 |



AC20111MT

#### Modular MCB

|                |   |     |        |
|----------------|---|-----|--------|
| <b>AC628MT</b> | 16A - SP - Modular MCB - C Curve - 1 Module | 916 | 1/5/50 |
| <b>AC625MT</b> | 20A - SP - Modular MCB - C Curve - 1 Module | 916 | 1/5/50 |
| <b>AC626MT</b> | 32A - SP - Modular MCB - C Curve - 1 Module | 916 | 1/5/50 |



AC628MT



AC625MT



AC626MT

#### Audio-Video Sockets

|                 |  |       |          |
|-----------------|--|-------|----------|
| <b>AC4430MT</b> | Female 3.5mm Jack - 1 Module                 | 7424  | 1/10     |
| <b>AC4421MT</b> | Preterminated Sockets Female Hd15 - 1 Module | 10240 | 1/10     |
| <b>AC4411MT</b> | Preterminated HDMI Socket - 1.4 - 1 Module   | 11604 | 1/10     |
| <b>AC4400MT</b> | Loudspeaker Socket - 1 Module                | 1300  | 1/10/100 |
| <b>AC4452MT</b> | Male XLR Jack - 2 Module                     | 10954 | 1/20     |



AC4430MT



AC4411MT



AC4400MT

## Arteor Advance™

**NEW!**

### Protectors & Accessories

| Cat.Nos | Description | MRP*<br>₹ / Unit | Pack |
|---------|-------------|------------------|------|
|---------|-------------|------------------|------|

#### Audio-Video Sockets

|                 |  |       |        |
|-----------------|--|-------|--------|
| <b>AC4412MT</b> | Preterminated HDMI Socket - 1.4 - 2 Module   | 12188 | 1/10   |
| <b>AC4106MT</b> | TV-R-SAT Socket - 2 Module                   | 6582  | 1/0/10 |
| <b>AC4442MT</b> | Triple RCA Socket (Audio & Video) - 1 Module | 6526  | 1/20   |
| <b>AC4362MT</b> | Preterminated USB Data Socket - 1 Module     | 8754  | 1/10   |
| <b>AC4360MT</b> | USB Socket - 1 Module                        | 5882  | 2/0/20 |
| <b>AC4470MT</b> | Line Dying Down - 100V (25 - 30W) - 2 Module | 21094 | 1/20   |
| <b>AC4450MT</b> | Female XLR Jack - 2 Module                   | 13178 | 1/20   |
| <b>AC4440MT</b> | 2 Female RCA Socket - 1 Module               | 5318  | 1/10   |



AC4106MT



AC4362MT



AC4360MT



AC4450MT



AC354MT

#### Cable Outlet

|                |  |     |        |
|----------------|--|-----|--------|
| <b>AC354MT</b> | Cord Outlet - with 8mm Diameter - 1 Module | 632 | 20/200 |
|----------------|--|-----|--------|

#### Blanking Plate

|                |                           |     |          |
|----------------|---------------------------|-----|----------|
| <b>AC150MT</b> | Blanking Plate - 1 Module | 80  | 1/40/400 |
| <b>AC153MT</b> | Blanking Plate - 2 Module | 138 | 1/10/100 |



AC153MT

## Elite Matt White Mechanisms

| Cat.Nos | Description | MRP*<br>₹ / Unit | Pack |
|---------|-------------|------------------|------|
|---------|-------------|------------------|------|

#### Switches - 10A - 230V AC

|                  |   |     |          |
|------------------|---|-----|----------|
| <b>AA21104MW</b> | 10A - Switch - 1 Way - 1 Module                       | 316 | 1/10/100 |
| <b>AA21106MW</b> | 10A - Switch - 1 Way - with Indicator - 1 Module      | 586 | 1/10/100 |
| <b>AA21105MW</b> | 10A - Switch - 1 Way - with Locator - 1 Module        | 586 | 1/10/100 |
| <b>AA21102MW</b> | 10A - Switch - 1 Way - with Locator (Blue) - 1 Module | 586 | 1/10/100 |
| <b>AA22105MW</b> | 10A - Switch - 2 Way - 1 Module                       | 520 | 1/10/100 |
| <b>AA22107MW</b> | 10A - Switch - 2 Way - with Indicator - 1 Module      | 732 | 1/10/100 |



AA21104MW



AA21102MW



AA22107MW

\* MRP - Maximum Retail Price Inclusive of all taxes including GST.  
Red Cat. Nos - New Products

Bold Cat.Nos are products normally available with Legrand (India) Stockists. Cat.Nos that are not bold - delivery within 4 - 8 weeks from the date of order. Bold packing quantity is our mandatory packing. Orders to be placed by Legrand (India) Stockist in multiples of the same.

## Arteor Advance™

**NEW!** Elite Matt White Mechanisms

| Cat.Nos | Description | MRP*<br>₹ / Unit | Pack |
|---------|-------------|------------------|------|
|---------|-------------|------------------|------|

### Switches – 16A - 230V AC

|                  |  |     |          |
|------------------|--|-----|----------|
| <b>AA21101MW</b> | 16A - Switch - 1 Way - 1 Module                  | 528 | 1/10/100 |
| <b>AA21120MW</b> | 16A - Switch - 1 Way - with Indicator - 1 Module | 676 | 1/10/100 |
| <b>AA22101MW</b> | 16A - Switch - 2 Way - 1 Module                  | 828 | 1/10/100 |
| <b>AA22102MW</b> | 16A - Switch - 2 Way - with Indicator - 1 Module | 842 | 1/10/100 |

### Switches – 20A - 230V AC

|                  |  |      |          |
|------------------|--|------|----------|
| <b>AA21107MW</b> | 20A - Switch - 1 Way - 1 Module                  | 702  | 1/10/100 |
| <b>AA21108MW</b> | 20A - Switch - 1 Way - with Indicator - 1 Module | 798  | 1/10/100 |
| <b>AA22106MW</b> | 20A - Switch - 2 Way - 1 Module                  | 914  | 1/10/100 |
| <b>AA22108MW</b> | 20A - Switch - 2 Way - with Indicator - 1 Module | 1016 | 1/10/100 |

### Push Button – 10A - 230V AC

|                  |  |     |          |
|------------------|--|-----|----------|
| <b>AA23102MW</b> | 10A - Bell Push - 1 Way - 1 Module                       | 582 | 1/10/100 |
| <b>AA23103MW</b> | 10A - Bell Push - 1 Way - with Locator - 1 Module        | 772 | 1/10/100 |
| <b>AA23104MW</b> | 10A - Bell Push - 1 Way - with Locator (Blue) - 1 Module | 772 | 1/10/100 |
| <b>AA23101MW</b> | 10A - Push Button - 1 Way - 1 Module                     | 616 | 1/10/100 |
| <b>AA23108MW</b> | 10A - Push Button - 2 Way - 1 Module                     | 856 | 1/10/100 |

### Electric Roller Blinds

|                  |   |      |        |
|------------------|---|------|--------|
| <b>AA26104MW</b> | Double Switch for Electric Shutter - 2 Module | 1420 | 1/5/50 |
|------------------|---|------|--------|

### Dimmers and Fan Regulators

|                  |   |       |        |
|------------------|---|-------|--------|
| <b>AA24107MW</b> | Rotary Dimmer 200W LED - 2 Module                   | 24158 | 1/10   |
| <b>AA667MW</b>   | Fan Step Regulator - 70 Watts - ISI - 2 Module      | 2532  | 1/3/30 |
| <b>AA664MW</b>   | Fan Regulator - 8 Step - 100 Watts - ISI - 2 Module | 2264  | 1/3/30 |
| <b>AA669MW</b>   | Fan Step Regulator - 120 Watts - ISI - 2 Module     | 2540  | 1/3/30 |

### Temperature Room Control Unit

|                |                               |       |      |
|----------------|-------------------------------|-------|------|
| <b>AA674MW</b> | Temperature Room Control Unit | 20502 | 1/20 |
|----------------|-------------------------------|-------|------|

### USB Chargers

|                 |   |       |      |
|-----------------|---|-------|------|
| <b>AA3406MW</b> | USB Charger - Power Delivery - 30 Watts - Type C + C - 2 Module | 12730 | 1/20 |
| <b>AA3401MW</b> | USB Charger - Power Delivery - 45 Watts - Type C - 2 Module     | 16428 | 1/20 |

\* MRP - Maximum Retail Price Inclusive of all taxes including GST.  
Red Cat. Nos - New Products

## Arteor Advance™

**NEW!** Hospitality Function

| Cat.Nos | Description | MRP*<br>₹ / Unit | Pack |
|---------|-------------|------------------|------|
|---------|-------------|------------------|------|

### Hotel "DND and MMR" functions

|                  |   |      |        |
|------------------|---|------|--------|
| <b>AA27107MW</b> | Interlocked Internal DND & MMR Control Unit - 2 Module      | 2838 | 1/5/50 |
| <b>AA27108MW</b> | External DND & MMR Control Unit - with Bell Push - 2 Module | 3956 | 1/5/50 |

### Master Push Button

|                  |                                       |     |          |
|------------------|---------------------------------------|-----|----------|
| <b>AA23115MW</b> | Master Push ON/OFF - 2 Way - 1 Module | 954 | 1/10/100 |
|------------------|---------------------------------------|-----|----------|

### Bedlight Switch

|                  |  |     |        |
|------------------|--|-----|--------|
| <b>AA21117MW</b> | 10A - Bedlight Switch - 2 Way - 2X1 2 Module   | 934 | 1/5/50 |
| <b>AA23119MW</b> | 10A - Push for Bedlight - 2 Way - 2X1 2 Module | 934 | 1/5/50 |

### Blanking Plate

|                |                           |     |          |
|----------------|---------------------------|-----|----------|
| <b>AA150MW</b> | Blanking Plate - 1 Module | 102 | 1/10/100 |
|----------------|---------------------------|-----|----------|

## Arteor Advance™

Elite Matt Black Mechanisms

| Cat.Nos | Description | MRP*<br>₹ / Unit | Pack |
|---------|-------------|------------------|------|
|---------|-------------|------------------|------|

### Switches – 10A - 230V AC

|                  |  |     |          |
|------------------|--|-----|----------|
| <b>AA21104MB</b> | 10A - Switch - 1 Way - 1 Module                  | 368 | 1/10/100 |
| <b>AA21106MB</b> | 10A - Switch - 1 Way - with Indicator - 1 Module | 668 | 1/10/100 |
| <b>AA21105MB</b> | 10A - Switch - 1 Way - with Locator - 1 Module   | 668 | 1/10/100 |
| <b>AA22105MB</b> | 10A - Switch - 2 Way - 1 Module                  | 600 | 1/10/100 |
| <b>AA22107MB</b> | 10A - Switch - 2 Way - with Indicator - 1 Module | 856 | 1/10/100 |

### Switches – 16A - 230V AC

|                  |  |     |          |
|------------------|--|-----|----------|
| <b>AA21101MB</b> | 16A - Switch - 1 Way - 1 Module                  | 616 | 1/10/100 |
| <b>AA21120MB</b> | 16A - Switch - 1 Way - with Indicator - 1 Module | 768 | 1/10/100 |
| <b>AA22101MB</b> | 16A - Switch - 2 Way - 1 Module                  | 958 | 1/10/100 |
| <b>AA22102MB</b> | 16A - Switch - 2 Way - with Indicator - 1 Module | 984 | 1/10/100 |

### Switches – 20A - 230V AC

|                  |  |      |          |
|------------------|--|------|----------|
| <b>AA21107MB</b> | 20A - Switch - 1 Way - 1 Module                  | 798  | 1/10/100 |
| <b>AA21108MB</b> | 20A - Switch - 1 Way - with Indicator - 1 Module | 920  | 1/10/100 |
| <b>AA22106MB</b> | 20A - Switch - 2 Way - 1 Module                  | 1034 | 1/10/100 |
| <b>AA22108MB</b> | 20A - Switch - 2 Way - with Indicator - 1 Module | 1148 | 1/10/100 |

Bold Cat.Nos are products normally available with Legrand (India) Stockists. Cat.Nos that are not bold - delivery within 4 - 8 weeks from the date of order. Bold packing quantity is our mandatory packing. Orders to be placed by Legrand (India) Stockist in multiples of the same.

## Arteor Advance™

**NEW!** Elite Matt Black Mechanisms

| Cat.Nos | Description | MRP*<br>₹ / Unit | Pack |
|---------|-------------|------------------|------|
|---------|-------------|------------------|------|

### Push Button – 10A - 230V AC

|                  |   |     |          |
|------------------|---|-----|----------|
| <b>AA23102MB</b> | 10A - Bell Push - 1 Way - 1 Module                | 654 | 1/10/100 |
| <b>AA23103MB</b> | 10A - Bell Push - 1 Way - with Locator - 1 Module | 902 | 1/10/100 |
| <b>AA23101MB</b> | 10A - Push Button - 1 Way - 1 Module              | 680 | 1/10/100 |
| <b>AA23108MB</b> | 10A - Push Button - 2 Way - 1 Module              | 996 | 1/5/50   |

### Electric Roller Blinds and Curtain Control

|                  |   |      |        |
|------------------|---|------|--------|
| <b>AA26104MB</b> | Double Switch for Electric Shutter - 2 Module | 1650 | 1/5/50 |
|------------------|---|------|--------|

### Dimmers and Fan Regulators

|                  |   |       |        |
|------------------|---|-------|--------|
| <b>AA24107MB</b> | Rotary Dimmer 200W LED - 2 Module                   | 26138 | 1/10   |
| <b>AA667MB</b>   | Fan Step Regulator - 70 Watts - ISI - 2 Module      | 2904  | 1/3/30 |
| <b>AA664MB</b>   | Fan Regulator - 8 Step - 100 Watts - ISI - 2 Module | 2598  | 1/3/30 |
| <b>AA669MB</b>   | Fan Step Regulator - 120 Watts - ISI - 2 Module     | 2928  | 1/3/30 |

### Temperature Room Control Unit

|                |                               |       |      |
|----------------|-------------------------------|-------|------|
| <b>AA674MB</b> | Temperature Room Control Unit | 23578 | 1/20 |
|----------------|-------------------------------|-------|------|

### USB Chargers

|                 |   |       |      |
|-----------------|---|-------|------|
| <b>AA3406MB</b> | USB Charger - Power Delivery - 30 Watts - Type C + C - 2 Module | 13318 | 1/20 |
| <b>AA3401MB</b> | USB Charger - Power Delivery - 45 Watts - Type C - 2 Module     | 17184 | 1/20 |

## Arteor Advance™

### Hospitality Function

#### Hotel "DND and MMR" functions

|                  |   |      |        |
|------------------|---|------|--------|
| <b>AA27107MB</b> | Interlocked Internal DND & MMR Control Unit - 2 Module      | 3278 | 1/5/50 |
| <b>AA27108MB</b> | External DND & MMR Control Unit - with Bell Push - 2 Module | 4532 | 1/5/50 |

## Arteor Advance™

**NEW!** Hospitality Function

| Cat.Nos | Description | MRP*<br>₹ / Unit | Pack |
|---------|-------------|------------------|------|
|---------|-------------|------------------|------|

### Master Push Button

|                  |                                       |      |          |
|------------------|---------------------------------------|------|----------|
| <b>AA23115MB</b> | Master Push ON/OFF - 2 Way - 1 Module | 1088 | 1/10/100 |
|------------------|---------------------------------------|------|----------|

### Bedlight Switch

|                  |  |      |        |
|------------------|--|------|--------|
| <b>AA21117MB</b> | 10A - Bedlight Switch - 2 Way - 2X1 2 Module   | 1088 | 1/5/50 |
| <b>AA23119MB</b> | 10A - Push for Bedlight - 2 Way - 2X1 2 Module | 1088 | 1/5/50 |

### Blanking Plate

|                |                           |    |          |
|----------------|---------------------------|----|----------|
| <b>AA150MB</b> | Blanking Plate - 1 Module | 98 | 1/10/100 |
|----------------|---------------------------|----|----------|

## Arteor Advance™

### Elite - Matt Titanium Mechanisms

| Cat.Nos | Description | MRP*<br>₹ / Unit | Pack |
|---------|-------------|------------------|------|
|---------|-------------|------------------|------|

### Switches – 10A - 230V AC

|                  |  |     |          |
|------------------|--|-----|----------|
| <b>AA21104MT</b> | 10A - Switch - 1 Way - 1 Module                  | 368 | 1/10/100 |
| <b>AA21106MT</b> | 10A - Switch - 1 Way - with Indicator - 1 Module | 668 | 1/10/100 |
| <b>AA21105MT</b> | 10A - Switch - 1 Way - with Locator - 1 Module   | 668 | 1/10/100 |
| <b>AA22105MT</b> | 10A - Switch - 2 Way - 1 Module                  | 600 | 1/10/100 |
| <b>AA22107MT</b> | 10A - Switch - 2 Way - with Indicator - 1 Module | 856 | 1/10/100 |

### Switches – 16A - 230V AC

|                  |  |     |          |
|------------------|--|-----|----------|
| <b>AA21101MT</b> | 16A - Switch - 1 Way - 1 Module                  | 616 | 1/10/100 |
| <b>AA21120MT</b> | 16A - Switch - 1 Way - with Indicator - 1 Module | 768 | 1/10/100 |
| <b>AA22101MT</b> | 16A - Switch - 2 Way - 1 Module                  | 958 | 1/10/100 |
| <b>AA22102MT</b> | 16A - Switch - 2 Way - with Indicator - 1 Module | 984 | 1/10/100 |

### Switches – 20A - 230V AC

|                  |  |      |          |
|------------------|--|------|----------|
| <b>AA21107MT</b> | 20A - Switch - 1 Way - 1 Module                  | 798  | 1/10/100 |
| <b>AA21108MT</b> | 20A - Switch - 1 Way - with Indicator - 1 Module | 920  | 1/10/100 |
| <b>AA22106MT</b> | 20A - Switch - 2 Way - 1 Module                  | 1034 | 1/10/100 |
| <b>AA22108MT</b> | 20A - Switch - 2 Way - with Indicator - 1 Module | 1148 | 1/10/100 |

\* MRP - Maximum Retail Price Inclusive of all taxes including GST.  
Red Cat. Nos - New Products

Bold Cat.Nos are products normally available with Legrand (India) Stockists. Cat.Nos that are not bold - delivery within 4 - 8 weeks from the date of order. Bold packing quantity is our mandatory packing. Orders to be placed by Legrand (India) Stockist in multiples of the same.

## Arteor Advance™

### NEW! Elite - Matt Titanium Mechanisms

| Cat.Nos | Description | MRP*<br>₹ / Unit | Pack |
|---------|-------------|------------------|------|
|---------|-------------|------------------|------|

#### Push Button – 10A - 230V AC

|                  |   |     |          |
|------------------|---|-----|----------|
| <b>AA23102MT</b> | 10A - Bell Push - 1 Way - 1 Module                | 654 | 1/10/100 |
| <b>AA23103MT</b> | 10A - Bell Push - 1 Way - with Locator - 1 Module | 902 | 1/10/100 |
| <b>AA23101MT</b> | 10A - Push Button - 1 Way - 1 Module              | 680 | 1/10/100 |
| <b>AA23108MT</b> | 10A - Push Button - 2 Way - 1 Module              | 996 | 1/5/50   |

#### Electric Roller Blinds and Curtain Control

|                  |   |      |        |
|------------------|---|------|--------|
| <b>AA26104MT</b> | Double Switch for Electric Shutter - 2 Module | 1650 | 1/5/50 |
|------------------|---|------|--------|

#### Dimmers and Fan Regulators

|                  |   |       |        |
|------------------|---|-------|--------|
| <b>AA24107MT</b> | Rotary Dimmer 200W LED - 2 Module                   | 26138 | 1/10   |
| <b>AA667MT</b>   | Fan Step Regulator - 70 Watts - ISI - 2 Module      | 2904  | 1/3/30 |
| <b>AA664MT</b>   | Fan Regulator - 8 Step - 100 Watts - ISI - 2 Module | 2598  | 1/3/30 |
| <b>AA669MT</b>   | Fan Step Regulator - 120 Watts - ISI - 2 Module     | 2928  | 1/3/30 |

#### Temperature Room Control Unit

|                |                               |       |      |
|----------------|-------------------------------|-------|------|
| <b>AA674MT</b> | Temperature Room Control Unit | 23578 | 1/20 |
|----------------|-------------------------------|-------|------|

#### USB Chargers

|                 |   |       |      |
|-----------------|---|-------|------|
| <b>AA3406MT</b> | USB Charger - Power Delivery - 30 Watts - Type C + C - 2 Module | 13318 | 1/20 |
| <b>AA3401MT</b> | USB Charger - Power Delivery - 45 Watts - Type C - 2 Module     | 17184 | 1/20 |

#### Hospitality Function

| Cat.Nos | Description | MRP*<br>₹ / Unit | Pack |
|---------|-------------|------------------|------|
|---------|-------------|------------------|------|

#### Hotel "DND and MMR" functions

|                  |   |      |        |
|------------------|---|------|--------|
| <b>AA27107MT</b> | Interlocked Internal DND & MMR Control Unit - 2 Module      | 3278 | 1/5/50 |
| <b>AA27108MT</b> | External DND & MMR Control Unit - with Bell Push - 2 Module | 4532 | 1/5/50 |

## Arteor Advance™

### NEW! Classic- Cover Plate with Support Frame

| Cat.Nos | Description | MRP*<br>₹ / Unit | Pack |
|---------|-------------|------------------|------|
|---------|-------------|------------------|------|

#### Master Push Button

|                  |                                       |      |          |
|------------------|---------------------------------------|------|----------|
| <b>AA23115MT</b> | Master Push ON/OFF - 2 Way - 1 Module | 1088 | 1/10/100 |
|------------------|---------------------------------------|------|----------|

#### Bedlight Switch

|                  |  |      |        |
|------------------|--|------|--------|
| <b>AA21117MT</b> | 10A - Bedlight Switch - 2 Way - 2X1 2 Module   | 1088 | 1/5/50 |
| <b>AA23119MT</b> | 10A - Push for Bedlight - 2 Way - 2X1 2 Module | 1088 | 1/5/50 |

#### Blanking Plate

|                |                           |    |          |
|----------------|---------------------------|----|----------|
| <b>AA150MT</b> | Blanking Plate - 1 Module | 98 | 1/10/100 |
|----------------|---------------------------|----|----------|

#### White Cover Plate with Support Frame

|                 |   |      |        |
|-----------------|---|------|--------|
| <b>AC1200MW</b> | Cover Plate + Frame - 1 Module - Matt White           | 510  | 10/100 |
| <b>AC1201MW</b> | Cover Plate + Frame - 2 Module - Matt White           | 528  | 10/100 |
| <b>AC1202MW</b> | Cover Plate + Frame - 3 Module - Matt White           | 612  | 10/100 |
| <b>AC1203MW</b> | Cover Plate + Frame - 4 Module - Matt White           | 700  | 5/50   |
| <b>AC1205MW</b> | Cover Plate + Frame - 6 Module - Matt White           | 964  | 5/30   |
| <b>AC1207MW</b> | Cover Plate + Frame - 8 Module - Matt White           | 1140 | 5/30   |
| <b>AC1208MW</b> | Cover Plate + Frame - 2*4 Module - Matt White         | 1666 | 2/20   |
| <b>AC1212MW</b> | Cover Plate + Frame - 9 Module - Matt White           | 1768 | 5/30   |
| <b>AC1210MW</b> | Cover Plate + Frame - 2*6 Module - Matt White         | 2216 | 2/16   |
| <b>AC1213MW</b> | Cover Plate + Frame - 2*8 Module - Matt White         | 2436 | 2/16   |
| <b>AC1211MW</b> | Cover Plate + Frame - 3*6 Module - Matt White         | 2872 | 2/12   |
| <b>AC1136MW</b> | Cover Plate - for Shaver Socket-3 Module - Matt White | 638  | 5/50   |

#### Matt Black Cover Plate with Support Frame

|                 |   |      |        |
|-----------------|---|------|--------|
| <b>AC1200MB</b> | Cover Plate + Frame - 1 Module - Matt Black | 614  | 10/100 |
| <b>AC1201MB</b> | Cover Plate + Frame - 2 Module - Matt Black | 648  | 10/100 |
| <b>AC1202MB</b> | Cover Plate + Frame - 3 Module - Matt Black | 686  | 10/100 |
| <b>AC1203MB</b> | Cover Plate + Frame - 4 Module - Matt Black | 778  | 5/50   |
| <b>AC1205MB</b> | Cover Plate + Frame - 6 Module - Matt Black | 1330 | 5/30   |

\* MRP - Maximum Retail Price Inclusive of all taxes including GST.  
Red Cat. Nos - New Products

Bold Cat.Nos are products normally available with Legrand (India) Stockists. Cat.Nos that are not bold - delivery within 4 - 8 weeks from the date of order. Bold packing quantity is our mandatory packing. Orders to be placed by Legrand (India) Stockist in multiples of the same.

## Arteor Advance™

### NEW! Classic- Cover Plate with Support Frame

| Cat.Nos | Description | MRP*<br>₹ / Unit | Pack |
|---------|-------------|------------------|------|
|---------|-------------|------------------|------|

#### Matt Black Cover Plate with Support Frame

|                 |   |      |      |
|-----------------|---|------|------|
| <b>AC1207MB</b> | Cover Plate + Frame - 8 Module - Matt Black           | 1476 | 5/30 |
| <b>AC1208MB</b> | Cover Plate + Frame - 2*4 Module - Matt Black         | 1872 | 2/20 |
| <b>AC1212MB</b> | Cover Plate + Frame - 9 Module - Matt Black           | 1986 | 5/30 |
| <b>AC1210MB</b> | Cover Plate + Frame - 2*6 Module - Matt Black         | 2430 | 2/16 |
| <b>AC1213MB</b> | Cover Plate + Frame - 2*8 Module - Matt Black         | 2760 | 2/16 |
| <b>AC1211MB</b> | Cover Plate + Frame - 3*6 Module - Matt Black         | 3226 | 2/12 |
| <b>AC1136MB</b> | Cover Plate - for Shaver Socket-3 Module - Matt Black | 1048 | 5/50 |

#### Matt Titanium Cover Plate with Support Frame

|                 |  |      |        |
|-----------------|--|------|--------|
| <b>AC1200MT</b> | Cover Plate + Frame - 1 Module - Matt Titanium           | 614  | 10/100 |
| <b>AC1201MT</b> | Cover Plate + Frame - 2 Module - Matt Titanium           | 648  | 10/100 |
| <b>AC1202MT</b> | Cover Plate + Frame - 3 Module - Matt Titanium           | 686  | 10/100 |
| <b>AC1203MT</b> | Cover Plate + Frame - 4 Module - Matt Titanium           | 778  | 5/50   |
| <b>AC1205MT</b> | Cover Plate + Frame - 6 Module - Matt Titanium           | 1330 | 5/30   |
| <b>AC1207MT</b> | Cover Plate + Frame - 8 Module - Matt Titanium           | 1476 | 5/30   |
| <b>AC1208MT</b> | Cover Plate + Frame - 2*4 Module - Matt Titanium         | 1872 | 2/20   |
| <b>AC1212MT</b> | Cover Plate + Frame - 9 Module - Matt Titanium           | 1986 | 5/30   |
| <b>AC1210MT</b> | Cover Plate + Frame - 2*6 Module - Matt Titanium         | 2430 | 2/16   |
| <b>AC1213MT</b> | Cover Plate + Frame - 2*8 Module - Matt Titanium         | 2760 | 2/16   |
| <b>AC1211MT</b> | Cover Plate + Frame - 3*6 Module - Matt Titanium         | 3226 | 2/12   |
| <b>AC1136MT</b> | Cover Plate - for Shaver Socket-3 Module - Matt Titanium | 1048 | 5/50   |

#### Frosted White Cover Plate with Support Frame

|                 |  |     |        |
|-----------------|--|-----|--------|
| <b>AC1200FW</b> | Cover Plate + Frame - 1 Module - Frosted White | 788 | 1/5/30 |
| <b>AC1201FW</b> | Cover Plate + Frame - 2 Module - Frosted White | 842 | 1/5/30 |
| <b>AC1202FW</b> | Cover Plate + Frame - 3 Module - Frosted White | 902 | 1/20   |
| <b>AC1203FW</b> | Cover Plate + Frame - 4 Module - Frosted White | 960 | 1/20   |

## Arteor Advance™

### NEW! Classic- Cover Plate with Support Frame

| Cat.Nos | Description | MRP*<br>₹ / Unit | Pack |
|---------|-------------|------------------|------|
|---------|-------------|------------------|------|

#### Frosted White Cover Plate with Support Frame

|                 |  |      |        |
|-----------------|--|------|--------|
| <b>AC1205FW</b> | Cover Plate + Frame - 6 Module - Frosted White           | 1746 | 1/5/30 |
| <b>AC1207FW</b> | Cover Plate + Frame - 8 Module - Frosted White           | 1922 | 1/5/30 |
| <b>AC1208FW</b> | Cover Plate + Frame - 2*4 Module - Frosted White         | 2482 | 1/10   |
| <b>AC1210FW</b> | Cover Plate + Frame - 2*6 Module - Frosted White         | 2998 | 1/16   |
| <b>AC1136FW</b> | Cover Plate - for Shaver Socket-3 Module - Frosted White | 1840 | 1/5/50 |

#### Frosted Black Cover Plate with Support Frame

|                 |  |      |        |
|-----------------|--|------|--------|
| <b>AC1200FB</b> | Cover Plate + Frame - 1 Module - Frosted Black           | 788  | 1/5/30 |
| <b>AC1201FB</b> | Cover Plate + Frame - 2 Module - Frosted Black           | 842  | 1/5/30 |
| <b>AC1202FB</b> | Cover Plate + Frame - 3 Module - Frosted Black           | 902  | 1/20   |
| <b>AC1203FB</b> | Cover Plate + Frame - 4 Module - Frosted Black           | 960  | 1/20   |
| <b>AC1205FB</b> | Cover Plate + Frame - 6 Module - Frosted Black           | 1746 | 1/5/30 |
| <b>AC1207FB</b> | Cover Plate + Frame - 8 Module - Frosted Black           | 1922 | 1/5/30 |
| <b>AC1208FB</b> | Cover Plate + Frame - 2*4 Module - Frosted Black         | 2482 | 1/10   |
| <b>AC1210FB</b> | Cover Plate + Frame - 2*6 Module - Frosted Black         | 2998 | 1/16   |
| <b>AC1136FB</b> | Cover Plate - for Shaver Socket-3 Module - Frosted Black | 1840 | 1/5/50 |

#### Brushed Stainless Steel Cover Plate with Support Frame

|                 |  |      |        |
|-----------------|--|------|--------|
| <b>AC1200BS</b> | Cover Plate + Frame - 1 Module - Brushed Stainless Steel | 3596 | 1/5/30 |
| <b>AC1201BS</b> | Cover Plate + Frame - 2 Module - Brushed Stainless Steel | 3844 | 1/5/30 |
| <b>AC1202BS</b> | Cover Plate + Frame - 3 Module - Brushed Stainless Steel | 4134 | 1/20   |
| <b>AC1203BS</b> | Cover Plate + Frame - 4 Module - Brushed Stainless Steel | 4388 | 1/20   |

\* MRP - Maximum Retail Price Inclusive of all taxes including GST.  
Red Cat. Nos - New Products

Bold Cat.Nos are products normally available with Legrand (India) Stockists. Cat.Nos that are not bold - delivery within 4 - 8 weeks from the date of order. Bold packing quantity is our mandatory packing. Orders to be placed by Legrand (India) Stockist in multiples of the same.

## Arteor Advance™

### NEW! Classic- Cover Plate with Support Frame

| Cat.Nos         | Description   | MRP*<br>₹ / Unit | Pack   |
|-----------------|---|------------------|--------|
| <b>AC1205BS</b> | Cover Plate + Frame<br>- 6 Module - Brushed<br>Stainless Steel              | 7986             | 1/5/30 |
| <b>AC1207BS</b> | Cover Plate + Frame<br>- 8 Module - Brushed<br>Stainless Steel              | 8782             | 1/5/30 |
| <b>AC1208BS</b> | Cover Plate +<br>Frame - 2*4 Module<br>- Brushed Stainless<br>Steel         | 11100            | 1/10   |
| <b>AC1210BS</b> | Cover Plate +<br>Frame - 2*6 Module<br>- Brushed Stainless<br>Steel         | 13682            | 1/16   |
| <b>AC1136BS</b> | Cover Plate - for<br>Shaver Socket-3<br>Module - Brushed<br>Stainless Steel | 4098             | 1/5/50 |

### Solid Aluminium Cover Plate with Support Frame

|                 |   |       |        |
|-----------------|---|-------|--------|
| <b>AC1200SA</b> | Cover Plate + Frame<br>- 1 Module - Solid<br>Aluminium              | 5134  | 1/5/30 |
| <b>AC1201SA</b> | Cover Plate + Frame<br>- 2 Module - Solid<br>Aluminium              | 5494  | 1/5/30 |
| <b>AC1202SA</b> | Cover Plate + Frame<br>- 3 Module - Solid<br>Aluminium              | 5908  | 1/20   |
| <b>AC1203SA</b> | Cover Plate + Frame<br>- 4 Module - Solid<br>Aluminium              | 6270  | 1/20   |
| <b>AC1205SA</b> | Cover Plate + Frame<br>- 6 Module - Solid<br>Aluminium              | 11408 | 1/5/30 |
| <b>AC1207SA</b> | Cover Plate + Frame<br>- 8 Module - Solid<br>Aluminium              | 12544 | 1/5/30 |
| <b>AC1208SA</b> | Cover Plate + Frame<br>- 2*4 Module - Solid<br>Aluminium            | 15856 | 1/10   |
| <b>AC1210SA</b> | Cover Plate + Frame<br>- 2*6 Module - Solid<br>Aluminium            | 19546 | 1/16   |
| <b>AC1136SA</b> | Cover Plate - for<br>Shaver Socket-3<br>Module - Solid<br>Aluminium | 5854  | 1/5/50 |

### Midnight Blue Cover Plate with Support Frame

|                 |  |      |        |
|-----------------|--|------|--------|
| <b>AC1200NB</b> | Cover Plate + Frame<br>- 1 Module - Midnight<br>Blue | 5134 | 1/5/30 |
| <b>AC1201NB</b> | Cover Plate + Frame<br>- 2 Module - Midnight<br>Blue | 5494 | 1/5/30 |

## Arteor Advance™

### NEW! Elite- Cover Plate with Support Frame

| Cat.Nos         | Description  | MRP*<br>₹ / Unit | Pack   |
|-----------------|--|------------------|--------|
| <b>AC1202NB</b> | Cover Plate + Frame<br>- 3 Module - Midnight<br>Blue           | 5908             | 1/20   |
| <b>AC1203NB</b> | Cover Plate + Frame<br>- 4 Module - Midnight<br>Blue           | 6270             | 1/20   |
| <b>AC1205NB</b> | Cover Plate + Frame<br>- 6 Module - Midnight<br>Blue           | 11408            | 1/5/30 |
| <b>AC1207NB</b> | Cover Plate + Frame<br>- 8 Module - Midnight<br>Blue           | 12544            | 1/5/30 |
| <b>AC1208NB</b> | Cover Plate + Frame -<br>2*4 Module - Midnight<br>Blue         | 15856            | 1/10   |
| <b>AC1210NB</b> | Cover Plate + Frame -<br>2*6 Module - Midnight<br>Blue         | 19546            | 1/16   |
| <b>AC1136NB</b> | Cover Plate - for<br>Shaver Socket-3<br>Module - Midnight Blue | 5854             | 1/5/50 |

### Round Plates with Support Frame

|                 |  |     |        |
|-----------------|--|-----|--------|
| <b>AA1202MW</b> | Cover Plate + Frame<br>- 2 Module - Round -<br>Matt White    | 658 | 10/100 |
| <b>AA1202MB</b> | Cover Plate + Frame<br>- 2 Module - Round -<br>Matt Black    | 808 | 10/100 |
| <b>AA1202MT</b> | Cover Plate + Frame<br>- 2 Module - Round -<br>Matt Titanium | 808 | 10/100 |

### Frosted White Cover Plate with Support Frame

|                   |  |      |        |
|-------------------|--|------|--------|
| <b>AA1200FW</b>   | Cover Plate + Frame<br>- 1 Module - 1 x Elite<br>- Frosted White | 984  | 1/5/30 |
| <b>AA1201FW</b>   | Cover Plate + Frame<br>- 2 Module - 2 x Elite<br>- Frosted White | 1054 | 1/5/30 |
| <b>AA1202FW</b>   | Cover Plate + Frame<br>- 2 Module - Round -<br>Frosted White     | 1054 | 1/5/30 |
| <b>AA1203FW</b>   | Cover Plate + Frame<br>- 3 Module - 3 x Elite<br>- Frosted White | 1130 | 1/20   |
| <b>AA1204FW**</b> | Cover Plate + Frame<br>- 4 Module - 4 x Elite<br>- Frosted White | 1248 | 1/5/30 |

\* MRP - Maximum Retail Price Inclusive of all taxes including GST.  
\*\*Lead Time : 8 - 10 weeks after order booking  
Red Cat. Nos - New Products

Bold Cat.Nos are products normally available with Legrand (India) Stockists.  
Cat.Nos that are not bold - delivery within 4 - 8 weeks from the date of order.  
Bold packing quantity is our mandatory packing. Orders to be placed by  
Legrand (India) Stockist in multiples of the same.

# Arteor Advance™

## NEW! Elite- Cover Plate with Support Frame

| Cat.Nos           | Description  | MRP*<br>₹ / Unit | Pack   |
|-------------------|--|------------------|--------|
| <b>AA1200FB</b>   | Cover Plate + Frame<br>- 1 Module - 1 x Elite<br>- Frosted Black | 984              | 1/5/30 |
| <b>AA1201FB</b>   | Cover Plate + Frame<br>- 2 Module - 2 x Elite<br>- Frosted Black | 1054             | 1/5/30 |
| <b>AA1202FB</b>   | Cover Plate + Frame<br>- 2 Module - Round -<br>Frosted Black     | 1054             | 1/5/30 |
| <b>AA1203FB</b>   | Cover Plate + Frame<br>- 3 Module - 3 x Elite<br>- Frosted Black | 1130             | 1/20   |
| <b>AA1204FB**</b> | Cover Plate + Frame<br>- 4 Module - 4 x Elite<br>- Frosted Black | 1248             | 1/5/30 |

## Brushed Stainless Steel Cover Plate with Support Frame

|                 |   |      |        |
|-----------------|---|------|--------|
| <b>AA1200BS</b> | Cover Plate + Frame<br>- 1 Module - 1 x Elite<br>- Brushed Stainless<br>Steel | 4492 | 1/5/30 |
| <b>AA1201BS</b> | Cover Plate + Frame<br>- 2 Module - 2 x Elite<br>- Brushed Stainless<br>Steel | 4806 | 1/5/30 |
| <b>AA1202BS</b> | Cover Plate + Frame<br>- 2 Module - Round<br>- Brushed Stainless<br>Steel     | 4806 | 1/5/30 |
| <b>AA1203BS</b> | Cover Plate + Frame<br>- 3 Module - 3 x Elite<br>- Brushed Stainless<br>Steel | 5170 | 1/20   |

## Solid Aluminium Cover Plate with Support Frame

|                   |  |      |        |
|-------------------|--|------|--------|
| <b>AA1200SA</b>   | Cover Plate + Frame<br>- 1 Module - 1 x Elite<br>- Solid Aluminium | 6418 | 1/5/30 |
| <b>AA1201SA</b>   | Cover Plate + Frame<br>- 2 Module - 2 x Elite<br>- Solid Aluminium | 6870 | 1/5/30 |
| <b>AA1202SA</b>   | Cover Plate + Frame<br>- 2 Module - Round -<br>Solid Aluminium     | 6870 | 1/5/30 |
| <b>AA1203SA</b>   | Cover Plate + Frame<br>- 3 Module - 3 x Elite<br>- Solid Aluminium | 7386 | 1/20   |
| <b>AA1204SA**</b> | Cover Plate + Frame<br>- 4 Module - 4 x Elite<br>- Solid Aluminium | 8150 | 1/5/30 |

\* MRP - Maximum Retail Price Inclusive of all taxes including GST.  
\*\*Lead Time : 8 - 10 weeks after order booking  
Red Cat. Nos - New Products

# Arteor Advance™



## NEW! Hybrid(Classic+Elite)- Cover Plate with Support Frame

| Cat.Nos           | Description  | MRP*<br>₹ / Unit | Pack   |
|-------------------|--|------------------|--------|
| <b>AA1200NB</b>   | Cover Plate + Frame<br>- 1 Module - 1 x Elite<br>- Midnight Blue | 6418             | 1/5/30 |
| <b>AA1201NB</b>   | Cover Plate + Frame<br>- 2 Module - 2 x Elite<br>- Midnight Blue | 6870             | 1/5/30 |
| <b>AA1202NB</b>   | Cover Plate + Frame<br>- 2 Module - Round -<br>Midnight Blue     | 6870             | 1/5/30 |
| <b>AA1203NB</b>   | Cover Plate + Frame<br>- 3 Module - 3 x Elite<br>- Midnight Blue | 7386             | 1/20   |
| <b>AA1204NB**</b> | Cover Plate + Frame<br>- 4 Module - 4 x Elite<br>- Midnight Blue | 8150             | 1/5/30 |

## Frosted White Cover Plate with Support Frame

|                 |   |      |        |
|-----------------|---|------|--------|
| <b>AB1208FW</b> | Cover Plate + Frame<br>- 4 Module - 2 x<br>Classic + 2 x Elite -<br>Frosted White | 1248 | 1/20   |
| <b>AB1203FW</b> | Cover Plate + Frame<br>- 6 Module - 3 x<br>Classic + 2 x Elite -<br>Frosted White | 2270 | 1/5/30 |
| <b>AB1205FW</b> | Cover Plate + Frame<br>- 6 Module - 4 x<br>Classic + 1 x Elite -<br>Frosted White | 2270 | 1/5/30 |
| <b>AB1202FW</b> | Cover Plate + Frame<br>- 6 Module - 3 x<br>Classic + Round -<br>Frosted White     | 2270 | 1/5/30 |
| <b>AB1207FW</b> | Cover Plate + Frame<br>- 8 Module - 5 x<br>Classic + Round -<br>Frosted White     | 2498 | 1/5/30 |

## Frosted Black Cover Plate with Support Frame

|                 |   |      |        |
|-----------------|---|------|--------|
| <b>AB1208FB</b> | Cover Plate + Frame<br>- 4 Module - 2 x<br>Classic + 2 x Elite -<br>Frosted Black | 1248 | 1/20   |
| <b>AB1203FB</b> | Cover Plate + Frame<br>- 6 Module - 3 x<br>Classic + 2 x Elite -<br>Frosted Black | 2270 | 1/5/30 |
| <b>AB1205FB</b> | Cover Plate + Frame<br>- 6 Module - 4 x<br>Classic + 1 x Elite -<br>Frosted Black | 2270 | 1/5/30 |
| <b>AB1202FB</b> | Cover Plate + Frame<br>- 6 Module - 3 x<br>Classic + Round -<br>Frosted Black     | 2270 | 1/5/30 |
| <b>AB1207FB</b> | Cover Plate + Frame<br>- 8 Module - 5 x<br>Classic + Round -<br>Frosted Black     | 2498 | 1/5/30 |

Bold Cat.Nos are products normally available with Legrand (India) Stockists.  
Cat.Nos that are not bold - delivery within 4 - 8 weeks from the date of order.  
Bold packing quantity is our mandatory packing. Orders to be placed by  
Legrand (India) Stockist in multiples of the same.

## Hybrid(Classic+Elite)- Cover Plate with Support Frame

**NEW!**

| Cat.Nos   | Description  | MRP*<br>₹ / Unit | Pack   |
|---|--|------------------|--------|
| <b>Brushed Stainless Steel Cover Plate with Support Frame</b> |  |                  |        |
| <b>AB1208BS</b>   | Cover Plate + Frame<br>- 4 Module - 2 x Classic + 2 x Elite<br>- Brushed Stainless Steel | 5704             | 1/20   |
| <b>AB1203BS</b>   | Cover Plate + Frame<br>- 6 Module - 3 x Classic + 2 x Elite<br>- Brushed Stainless Steel | 10382            | 1/5/30 |
| <b>AB1205BS</b>   | Cover Plate + Frame<br>- 6 Module - 4 x Classic + 1 x Elite<br>- Brushed Stainless Steel | 10382            | 1/5/30 |
| <b>AB1202BS</b>   | Cover Plate + Frame<br>- 6 Module - 3 x Classic + Round<br>- Brushed Stainless Steel     | 10382            | 1/5/30 |
| <b>AB1207BS</b>   | Cover Plate + Frame<br>- 8 Module - 5 x Classic + Round<br>- Brushed Stainless Steel     | 11418            | 1/5/30 |

### Solid Aluminium Cover Plate with Support Frame

|                 |   |       |        |
|-----------------|---|-------|--------|
| <b>AB1208SA</b> | Cover Plate + Frame<br>- 4 Module - 2 x Classic + 2 x Elite - Solid Aluminium | 8150  | 1/20   |
| <b>AB1203SA</b> | Cover Plate + Frame<br>- 6 Module - 3 x Classic + 2 x Elite - Solid Aluminium | 14832 | 1/5/30 |
| <b>AB1205SA</b> | Cover Plate + Frame<br>- 6 Module - 4 x Classic + 1 x Elite - Solid Aluminium | 14832 | 1/5/30 |
| <b>AB1202SA</b> | Cover Plate + Frame<br>- 6 Module - 3 x Classic + Round - Solid Aluminium     | 14832 | 1/5/30 |
| <b>AB1207SA</b> | Cover Plate + Frame<br>- 8 Module - 5 x Classic + Round - Solid Aluminium     | 16306 | 1/5/30 |

### Midnight Blue Cover Plate with Support Frame

|                 |   |       |        |
|-----------------|---|-------|--------|
| <b>AB1208NB</b> | Cover Plate + Frame<br>- 4 Module - 2 x Classic + 2 x Elite - Midnight Blue | 8150  | 1/20   |
| <b>AB1203NB</b> | Cover Plate + Frame<br>- 6 Module - 3 x Classic + 2 x Elite - Midnight Blue | 14832 | 1/5/30 |

## Hybrid(Classic+Elite)- Cover Plate with Support Frame

**NEW!**

| Cat.Nos         | Description   | MRP*<br>₹ / Unit | Pack   |
|-----------------|---|------------------|--------|
| <b>AB1205NB</b> | Cover Plate + Frame<br>- 6 Module - 4 x Classic + 1 x Elite - Midnight Blue | 14832            | 1/5/30 |
| <b>AB1202NB</b> | Cover Plate + Frame<br>- 6 Module - 3 x Classic + Round - Midnight Blue     | 14832            | 1/5/30 |
| <b>AB1207NB</b> | Cover Plate + Frame<br>- 8 Module - 5 x Classic + Round - Midnight Blue     | 16306            | 1/5/30 |

# Arteor Advance™





## Accessories- Metal Flush Boxes

|                |                              |     |    |
|----------------|------------------------------|-----|----|
| <b>6890 07</b> | Metal Flush Box - 1/2 Module | 170 | 40 |
| <b>6890 08</b> | Metal Flush Box - 3 Module   | 170 | 40 |
| <b>6890 09</b> | Metal Flush Box - 4 Module   | 226 | 40 |
| <b>6890 10</b> | Metal Flush Box - 6 Module   | 358 | 40 |
| <b>6890 42</b> | Metal Flush Box - 8 Module   | 416 | 40 |
| <b>6890 31</b> | Metal Flush Box - 4*2 Module | 414 | 20 |
| <b>6890 29</b> | Metal Flush Box - 9 Module   | 490 | 20 |
| <b>6890 11</b> | Metal Flush Box -12 Module   | 624 | 10 |
| <b>6890 13</b> | Metal Flush Box -16 Module   | 720 | 10 |
| <b>6890 12</b> | Metal Flush Box - 18 Module  | 788 | 10 |

\* MRP - Maximum Retail Price Inclusive of all taxes including GST.  
Red Cat. Nos - New Products

## Arteor Advance™

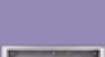
**NEW!** Accessories- Metal Flush Boxes

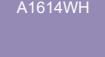
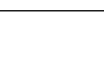
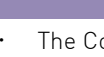
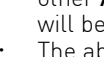
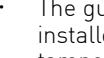
| Cat.Nos  | Description                      | MRP*<br>₹ / Unit | Pack |
|--|----------------------------------|------------------|------|
| <b>Surface Mounting Boxes</b>  |                                  |                  |      |
| <br>A1605WH   | Plastic Surface Box - 1/2 Module | 166              | 55   |
| <br>A1606WH   | Plastic Surface Box - 3 Module   | 202              | 42   |
| <br>A1607WH   | Plastic Surface Box - 4 Module   | 238              | 27   |
| <br>A1608WH   | Plastic Surface Box - 6 Module   | 298              | 20   |
| <br>A1609WH   | Plastic Surface Box - 8 Module   | 336              | 20   |
| <br>A1611WH  | Plastic Surface Box - 4*2 Module | 410              | 10   |
| <br>A1610WH | Plastic Surface Box - 9 Module   | 422              | 18   |
| <br>A1612WH | Plastic Surface Box - 12 Module  | 1046             | 11   |
| <br>A1614WH | Plastic Surface Box - 16 Module  | 1078             | 11   |
| <br>A1613WH | Plastic Surface Box - 18 Module  | 1106             | 8    |

## Arteor Advance™

### Guarantee

- The Company, at its discretion, will replace products if they have any manufacturing defect within 10 years for switches (without LED lamp) and power sockets. For all other **Arteor Advance™** wiring accessories the guarantee will be 2 years.
- The above guarantee is applicable when the devices are used in Legrand metal flush boxes. Otherwise the guarantee period will be reduced by 50%.
- The guarantee is only applicable when the products are installed as per the Company's instructions and not tampered in any manner.
- The guarantee states the Company's entire liability. It does not extend to cover consequential loss or damage or installation costs arising from defective products.

Our switches are compliant with revised BIS standard (IS 3854:2023) requirements. Also, our switches are covered additionally for use on Self-Ballasted Lamp (SBL) loads.

#### SBL power rating as per IS3854:2023

| Switch Rating    | 6A, 230V~ | 10A, 230V~ | 16A, 230V~ | 20A, 230V~ |
|------------------|-----------|------------|------------|------------|
| SBL power (Watt) | 100 W     | 100 W      | 200 W      | 250 W      |

\* MRP - Maximum Retail Price Inclusive of all taxes including GST.  
Red Cat. Nos - New Products

# ARTEOR™

## Versatile Wiring Devices for Global Projects



Arteor™ is a modular wiring device range designed to meet the needs of residential, commercial, and hospitality projects worldwide. Combining ergonomic design, premium finishes, and advanced control options, it supports everything from standard electrical installations to connected IoT and BUS-based automation systems.

### Features

- Ergonomic round and square rocker designs available in refined finishes
- Extensive finish palette with over 16 colours
- Extensive mechanism range with switches, dimmers, USB chargers, and data outlets
- Smart-ready solutions supporting automation, hotel controls, and scenario-based switching

### Benefits

- Supports global projects with compliance to IEC & BS
- Enhances interiors with premium materials and contemporary design options
- Supports modern connectivity needs with integrated charging and data solutions
- Enables scalable control from simple wiring setups to advanced automation systems



Scan to know more about the product.





Round rocker White



Round rocker Magnesium



Round rocker Champagne

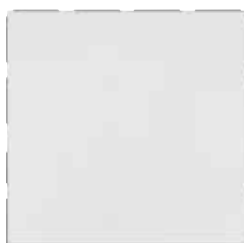

Square rocker White

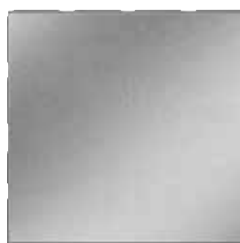

Square rocker Magnesium



Square rocker Champagne



# ARTEOR™

---

## Versatility & Modularity for Unrivalled Flexibility

Arteor™ is a modular range offering maximum flexibility in terms of installation and configuration.

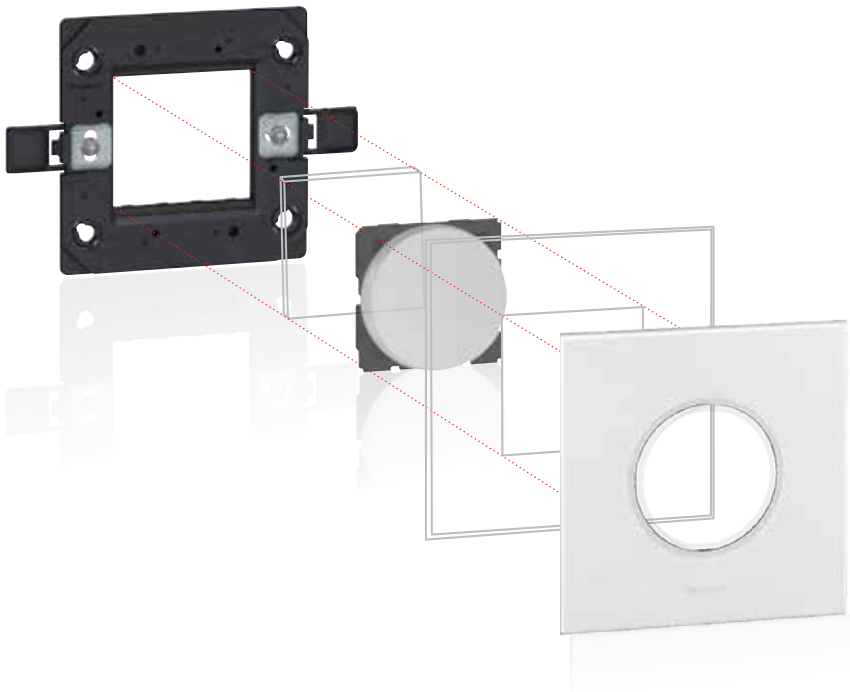

## Features that set ARTEOR™ apart



- ① Finger-proof terminals for IP 20 protection against accidental contact.
- ② Captive "never to loose" screws

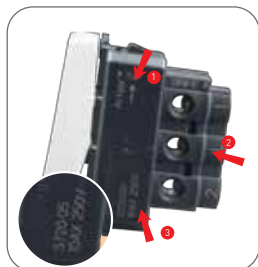

- ① Tunnel terminals preventing screwdrivers from slipping.
- ② Laser marking on mechanisms. Arrow showing the correct orientation of the mechanism.
- ③ The latest IS 3854 : 2023.



Sockets with ISI\* mark, conforming to IS 1293. Fan regulator with ISI\* mark, conforming to IS 11037.



Fully shrouded internal mechanism under the rocker preventing visibility of sparks.



- ① Stripping templates on sockets for stripping off exact length of insulation.



- ① Sockets are shuttered for child's safety against electric shocks.



Possibility of weather proofing mechanisms using Plexo IP 55 and IP 66 boxes.



For switches with LED lamps, life of LED is 50000 burning hours. Consumes power (0.76W) next to NIL.

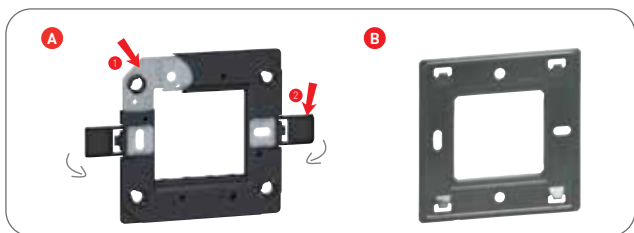

A. For all high end plates Metal frame providing solid support to base. Bi-material frame - electrical safety IP20. Screw caps can be closed once the support frame is installed, ensuring total insulation.



2x2 way switch - 3 controls possible in 2 module plate. In round and square design possible.



Mechanisms compatible with DLP trunking systems, columns, floor boxes and VDI installations.

# ARTEOR™

## The Ideal Solution, Always & Everywhere

Its versatility makes Arteor™ the ideal choice for every kind of project, anywhere in the world at any installation level. Arteor™ suits any requirement in terms of design and function for every kind of building, from residential to commercial.



TV socket



Skirting light

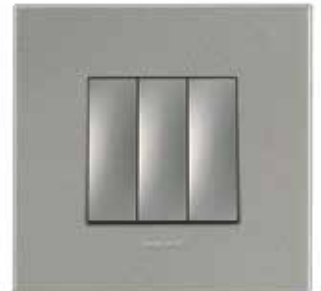

1-way switch - 3 gang



USB Charger  
Type C+C - 65W





6AX switch\*



Skirting light



USB charger  
Type C+C - 30W



Triple RCA socket



Time delay switch

\* Switch compatible with LED light

## Modern Home



# ARTEOR™

## Office & Hotel Solutions

Offices and collective spaces require specific solutions and maximum flexibility: lighting adapted to each situation (meeting, conference, etc.), access security, comprehensive multimedia connections. The Arteor™ range meets all these expectations with perfect adaptability.



Automatic switch



6A 1 way switch



USB socket



Preterminated HDMI sockets



Female HD15 + Jack



USB Charger  
Type C - 45W



From hotel room door to the beside table, Arteor™ provides all the solutions for the specific need of today's hotel industry. Comfort that extends to the hotel's communal areas, whether dedicated to the relaxation or work. The multitude of small details, gives the comfort feeling of being at home to the traveller.



Data sockets



4-Scenario touch control



S-Video socket



Keycard switch



External unit



Desk and Entrance Light



Bed light & curtain switch



Internal Unit

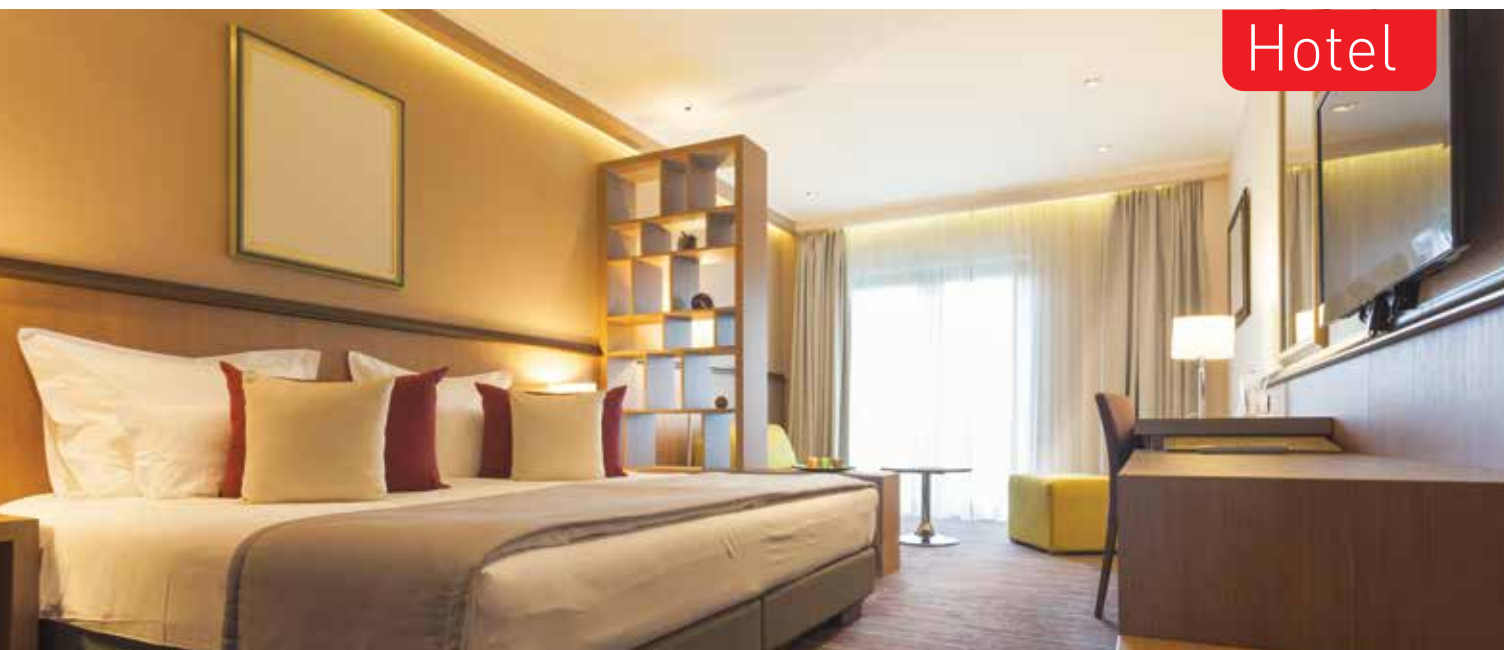

# ARTEOR™

## A Rich Choice of Finishes

### NEUTRAL

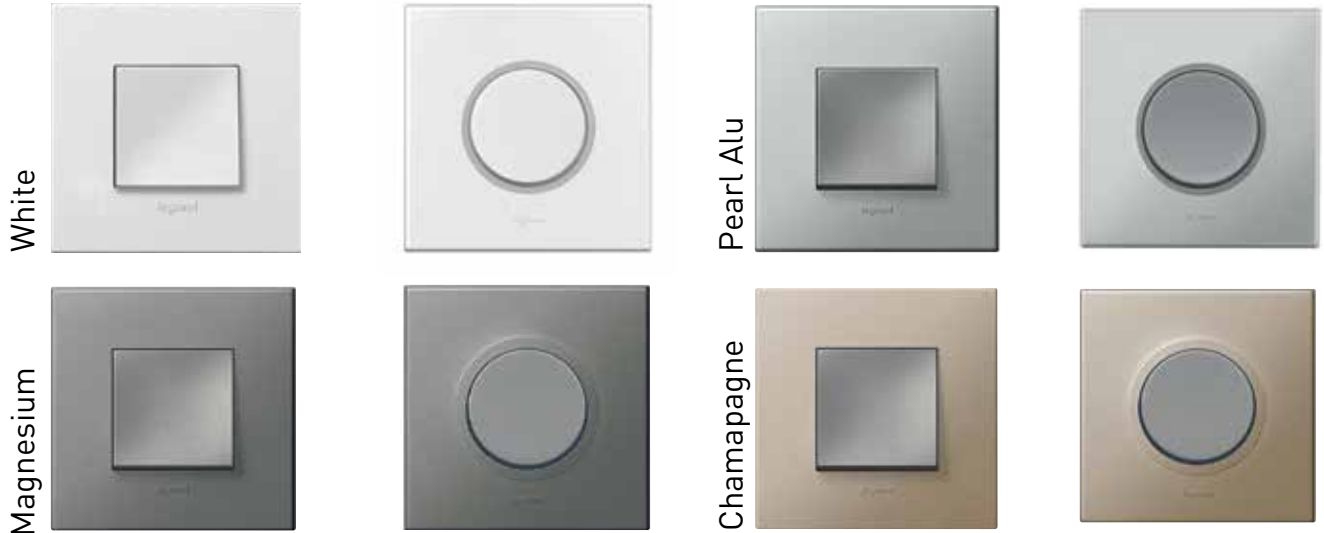

### MIRROR



### GRAPHIC

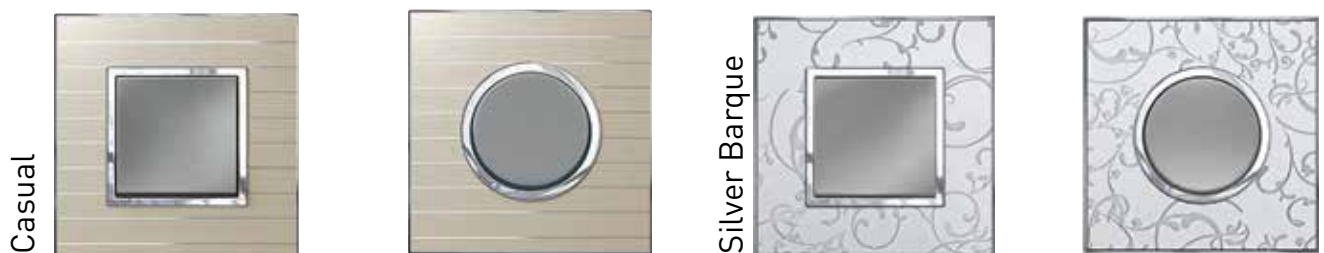

### METAL

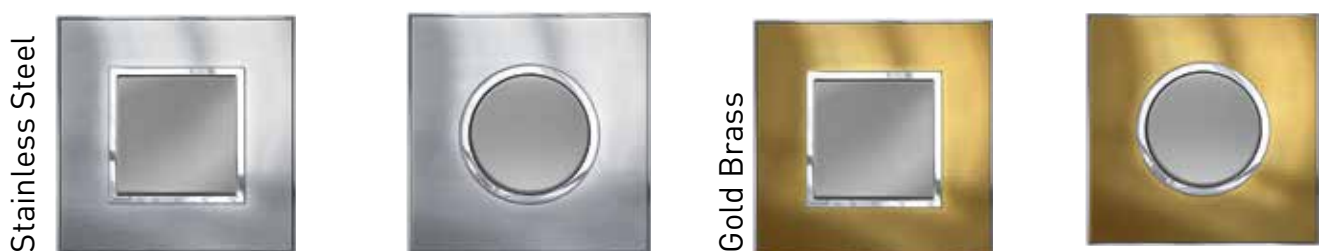

Graphite



Dark Bronze



Green Apple



Dark Barque



WOOD

Grey Oak



SIGNATURE

Cube



# ARTEOR™

## MyHOME

## Elegant and Intuitive Home Automation

Arteor™ MyHOME offers elegant home automation that combines beautiful design with simple touch control for lighting, blinds, HVAC, and more through intuitive touchscreens and smartphone apps.

### Features

- Full-range touchscreen interface for home control
- Smartphone app with dedicated icons for lights, temperature, blinds, and scenarios
- Seamless integration across electrical, wiring, and building infrastructure
- Versatile design suitable for rural, industrial, and digital environments

### Benefits

- Simplifies home management with intuitive touch and mobile control
- Enhances aesthetics while providing comprehensive automation
- Reduces complexity through unified interface for all systems
- Adapts to diverse architectural and lifestyle settings

Scan to know more about the product.



# THE FINISHING TOUCH



## Arteor™

### Square White Mechanism

| Cat.Nos | Description | MRP*<br>₹ / Unit | Pack |
|---------|-------------|------------------|------|
|---------|-------------|------------------|------|

#### Switches – 6A - 230V AC

|         |  |     |          |
|---------|--|-----|----------|
| 5734 00 | 6A - Switch - SP - 1 Way - 1 Module                  | 232 | 1/20/200 |
| 5734 01 | 6A - Switch - SP - 1 Way - with Indicator - 1 Module | 432 | 1/20/200 |
| 5734 02 | 6A - Switch - SP - 2 Way - 1 Module                  | 382 | 1/20/200 |
| 5734 03 | 6A - Switch - SP - 2 Way - with Indicator - 1 Module | 540 | 1/20/200 |

#### Switches – 10A - 230V AC

|         |  |      |          |
|---------|--|------|----------|
| 5734 50 | 10A - Switch - SP - 1 Way - 2 Module                                 | 456  | 1/10/100 |
| 5734 51 | 10A - Switch - SP - 2 Way - 2 Module                                 | 538  | 1/10/100 |
| 5720 37 | 10A - Switch - SP - 2 Way - with Indicator & Label Holder - 2 Module | 2552 | 5/50     |
| 5720 38 | 10A - Intermediate Switch - 230V AC - 2 Module                       | 3054 | 10/100   |

#### Switches – 20A - 230V AC

|         |  |      |          |
|---------|--|------|----------|
| 5734 10 | 20A - Switch - SP - 1 Way - 1 Module   | 520  | 1/20/200 |
| 5734 52 | 20A - Switch - SP - 1 Way - 2 Module   | 620  | 1/10/100 |
| 5720 63 | 20A - Switch - SP - 1 Way - with Indicator - 1 Module                        | 536  | 1/20/200 |
| 5734 11 | 20A - Switch - SP - 2 Way - with Indicator - 1 Module                        | 750  | 1/20/200 |
| 5720 42 | 20A - Switch - SP - 2 Way - with Indicator - 2 Module                        | 816  | 10/100   |
| 5720 43 | 20A - Switch - 3 Gang - 1 Way - 2 Module                                     | 1464 | 10/100   |
| 5720 44 | 20A - Switch - 3 Gang - 2*2 Way + 1*1 Way - 2 Module                         | 1604 | 10/100   |
| 5734 54 | 20A - Switch - DP - 1 Way - with Indicator - 2 Module                        | 1154 | 1/10/100 |
| 5720 49 | 20A - Switch - DP - 1 Way - with Indicator & Water Heater Marking - 2 Module | 1210 | 10/100   |

#### Accessory for Switch with Indicator

|         |  |    |      |
|---------|--|----|------|
| 5738 06 | LED for Switch - with Indicator (Blue) | 94 | 5/50 |
|---------|--|----|------|

#### Switches – 25A - 230V AC

|         |  |     |          |
|---------|--|-----|----------|
| 5734 17 | 25A - Switch - 1 Way - with Indicator - 1 Module | 696 | 1/20/200 |
|---------|--|-----|----------|

## Arteor™

### Square White Mechanism

| Cat.Nos | Description | MRP*<br>₹ / Unit | Pack |
|---------|-------------|------------------|------|
|---------|-------------|------------------|------|

#### Switches – 32A / 40A - 230V AC

|         |   |      |        |
|---------|---|------|--------|
| 5734 12 | 32A - Switch - DP - 1 Way - with Indicator - 2 Module               | 1646 | 10/100 |
| 5735 30 | 40A - Switch - DP - 1 Way - with Indicator - fits on 1/2 Module Box | 1896 | 1/5/20 |

#### Push Button – 6A - 230V AC

|         |   |     |          |
|---------|---|-----|----------|
| 5734 13 | 6A - Bell Push - SP - 1 Way - 1 Module                    | 418 | 1/20/200 |
| 5734 59 | 6A - Bell Push - SP - 1 Way - 2 Module                    | 590 | 1/10/100 |
| 5734 04 | 6A - Push Button - SP - 1 Way - 1 Module                  | 444 | 1/20/200 |
| 5734 05 | 6A - Push Button - SP - 1 Way - with Indicator - 1 Module | 560 | 1/20/200 |
| 5734 14 | 6A - Bell Push - SP - 1 Way - with Indicator - 1 Module   | 556 | 1/20/200 |
| 5734 60 | 6A - Bell Push - SP - 1 Way - with Indicator - 2 Module   | 792 | 1/10/100 |

#### Electric Roller Blinds Control

|         |   |      |          |
|---------|---|------|----------|
| 5722 20 | Double Switch for Electric Shutter - 2 Module | 1024 | 1/10/100 |
|---------|---|------|----------|

#### Dimmers & Fan Regulators

|         |   |      |          |
|---------|---|------|----------|
| 5734 62 | Light Dimmer - 60 to 400 Watts - 2 Module                           | 1720 | 1/10/100 |
| 5734 16 | Fan Step Regulator - 100 Watts - ISI - 1 Module                     | 1416 | 1/5/50   |
| 5734 63 | Fan Step Regulator - 100 Watts - ISI - 2 Module                     | 1746 | 1/10/100 |
| 5734 69 | Fan Step Regulator - 120 Watts - ISI - 2 Module (for 48 & 56" Fans) | 1868 | 1/10/100 |
| 5734 68 | Fan Step Regulator - for Energy Saving Fans - 2 Module              | 1864 | 1/10/100 |
| 5736 53 | Fan Regulator - 8 Steps - 100 Watts - ISI - 2 Module                | 1666 | 1/10/100 |

\* MRP - Maximum Retail Price Inclusive of all taxes including GST.

Bold Cat.Nos are products normally available with Legrand (India) Stockists. Cat.Nos that are not bold - delivery within 4 - 8 weeks from the date of order. Bold packing quantity is our mandatory packing. Orders to be placed by Legrand (India) Stockist in multiples of the same.

## Arteor™ Square White Mechanism

| Cat.Nos | Description | MRP*<br>₹ / Unit | Pack |
|---------|-------------|------------------|------|
|---------|-------------|------------------|------|

### Indian Standard Sockets

|         |   |      |          |
|---------|---|------|----------|
| 5734 24 | 6A - Socket - with Shutter - 3 Pin - ISI - 2 Module                 | 356  | 1/20/200 |
| 5734 71 | 6/16A - Socket - with Shutter - 3 Pin - Indian - ISI - 2 Module     | 722  | 1/10/100 |
| 5734 67 | 6/16A - Socket - with Shutter - 3 Pin - Indian - ISI - 3 Module     | 864  | 1/5/50   |
| 5735 10 | 16A - Socket Shutter with Switch - 3 Pin - 2P+E - Indian - 3 Module | 2018 | 5/50     |

### Energy Plugs

|         |            |     |          |
|---------|------------|-----|----------|
| 5738 86 | 6A - Plug  | 170 | 1/10/100 |
| 5738 88 | 16A - Plug | 228 | 1/10/100 |

### USB Chargers (IS13252 (Part 1) / IEC 60950-1)

|                     |   |       |          |
|---------------------|---|-------|----------|
| 5734 41             | USB Charger - 1500mA - Type A - 1 Module                        | 2722  | 1/5/50   |
| 5716 80             | USB Charger - 3000mA/15 Watts - Type A - 1 Module               | 3206  | 1/10/150 |
| 5716 84             | USB Charger - 3000mA/15 Watts - Type A + A - 1 Module           | 3626  | 1/10/150 |
| 5716 88             | USB Charger - 3000mA/15 Watts - Type A + C - 1 Module           | 4040  | 1/10/150 |
| 5716 92             | USB Charger - 3000mA/15 Watts - Type C + C - 1 Module           | 4526  | 1/10/150 |
| 5716 96             | USB Charger - Power Delivery - 20 Watts - Type C - 1 Module     | 6194  | 1/10/150 |
| 5734 81             | USB Charger - Power Delivery - 30 Watts - Type C + C - 2 Module | 9268  | 1/20     |
| 5754 81             | USB Charger - Power Delivery - 45 Watts - Type C - 2 Module     | 11962 | 1/20     |
| <b>NEW!</b> 5754 94 | USB Charger - Power Delivery - 65 Watts - Type C + C - 3 Module | 14650 | 1/20     |

### Data & Voice

|         |   |      |          |
|---------|---|------|----------|
| 5734 27 | Telephone Socket - Double RJ11 - 1 Module           | 642  | 1/20/200 |
| 5734 26 | Telephone Socket - RJ11 - with Shutter - 1 Module   | 374  | 1/20/200 |
| 5734 29 | Information Socket - RJ45 - Cat 5E - UTP - 1 Module | 739  | 1/20/200 |
| 5734 75 | Information Socket - RJ45 - Cat 5E - UTP - 2 Module | 788  | 1/10/100 |
| 5734 28 | Information Socket - RJ45 - Cat 6 - UTP - 1 Module  | 1127 | 1/20/200 |
| 5734 74 | Information Socket - RJ45 - Cat 6 - UTP - 2 Module  | 1184 | 1/10/100 |

\* MRP - Maximum Retail Price Inclusive of all taxes including GST.

^Coming Soon.

Red Cat. Nos - New Products

## Arteor™ Square White Mechanism

| Cat.Nos | Description | MRP*<br>₹ / Unit | Pack |
|---------|-------------|------------------|------|
|---------|-------------|------------------|------|

### Tv Sockets

|         |                                 |     |          |
|---------|---------------------------------|-----|----------|
| 5734 25 | TV Co - axial Socket - 1 Module | 390 | 1/20/200 |
|---------|---------------------------------|-----|----------|

### Electronic Chime

|         |                                  |     |          |
|---------|----------------------------------|-----|----------|
| 5734 43 | Bell Ding Dong - 230V - 2 Module | 686 | 1/10/100 |
|---------|----------------------------------|-----|----------|

### Buzzer

|         |                          |      |          |
|---------|--------------------------|------|----------|
| 5734 42 | Buzzer - 230V - 1 Module | 1822 | 1/20/200 |
|---------|--------------------------|------|----------|

### Bell Call Indicator & Register - 6A - 230V AC

|         |  |      |          |
|---------|--|------|----------|
| 5734 15 | 6A - Bell Call Indicator - SP - with Register - 1 Way - 1 Module | 2646 | 1/20/200 |
| 5736 06 | Set of Labels for Bell Call Indicator                            | 704  | 1/5/50   |

### Skirting Light

|         |  |       |          |
|---------|--|-------|----------|
| 5734 64 | Skirting Light - with LED - 230V - 3 Module            | 1420  | 1/10/100 |
| 5722 26 | Skirting Light - with Detector (LED) - 230V - 2 Module | 18570 | 1/20     |

### Lighting

|                      |  |     |        |
|----------------------|--|-----|--------|
| 5724 53              | Over Door Light Unit (Red) - 2 Module            | 798 | 10/100 |
| 5722 23              | Over Door Light Unit (White) - 2 Module          | 656 | 10/100 |
| <b>NEW!</b> 5735 97^ | Indicator Unit - with Transparent LED - 1 Module | 732 | 10/100 |

### Hospitality Function

#### Hotel "DND & MMR" Functions

|         |   |      |          |
|---------|---|------|----------|
| 5734 61 | External DND & MMR Control Unit - with Bell Push - 2 Module | 2840 | 1/5/50   |
| 5734 58 | Internal DND & MMR Control Unit - 2 Module                  | 2036 | 1/10/100 |

### Hotel Keycard Switch

|         |   |      |       |
|---------|---|------|-------|
| 5722 44 | 16A - Key Card Switch - 230V - 2 Module | 7752 | 1/10  |
| 5722 59 | Key Fob for Key Card Switch             | 2114 | 10/50 |

### Shaver Socket

|         |  |      |   |
|---------|--|------|---|
| 5721 53 | Shaver Socket - 230V/120 - 230V - with Earth Connector | 8056 | 1 |
|---------|--|------|---|

Bold Cat.Nos are products normally available with Legrand (India) Stockists. Cat.Nos that are not bold - delivery within 4 - 8 weeks from the date of order. Bold packing quantity is our mandatory packing. Orders to be placed by Legrand (India) Stockist in multiples of the same.

## Arteor™

### Square White Mechanism

| Cat.Nos | Description | MRP*<br>₹ / Unit | Pack |
|---------|-------------|------------------|------|
|---------|-------------|------------------|------|

#### Time Switch

|         |                              |      |      |
|---------|------------------------------|------|------|
| 5720 55 | Time Delay Switch - 2 Module | 9554 | 1/20 |
|---------|------------------------------|------|------|

#### Audio-Video Sockets

|         |  |       |      |
|---------|--|-------|------|
| 5722 72 | Double RCA Socket (Audio) - 1 Module         | 6074  | 1/20 |
| 5722 73 | Triple RCA Socket (Audio & Video) - 1 Module | 5448  | 1/20 |
| 5722 74 | Female 3.5mm Jack - 1 Module                 | 6043  | 1/20 |
| 5722 76 | Female BNC 75 Jack - 1 Module                | 6375  | 1/20 |
| 5722 83 | Female XLR Jack - 2 Module                   | 9372  | 1/20 |
| 5720 97 | Preterminated Sockets Female Hd15 - 1 Module | 8413  | 1    |
| 5720 96 | Preterminated HDMI Socket - 1.4 - 1 Module   | 9980  | 1    |
| 5722 84 | Line Dying Down - 100V (25 - 30W) - 2 Module | 15612 | 1    |
| 5722 77 | Male XLR Jack - 2 Module                     | 8575  | 1/20 |
| 5722 78 | Female 3.5mm Jack - Solder - 1 Module        | 4985  | 1/20 |
| 5722 75 | USB Socket - 1 Module                        | 4695  | 1/20 |
| 5722 88 | Female HD15 + Jack 3.5mm - 2 Module          | 6773  | 1/20 |

#### Cable Outlet

|         |  |      |          |
|---------|--|------|----------|
| 5734 80 | 45A - Cable Outlet - 2 Module              | 1560 | 5/50     |
| 5734 33 | Cord Outlet - with 8mm Diameter - 1 Module | 494  | 1/20/200 |
| 5734 79 | Standard Cord Outlet - 2 Module            | 714  | 10/100   |

#### Blanking Plate

|         |                                      |     |          |
|---------|--------------------------------------|-----|----------|
| 5734 49 | Blanking Plate - 1 Module            | 72  | 1/40/400 |
| 5723 44 | Blanking Plate - 2 Module            | 108 | 1/10/100 |
| 5758 10 | Blanking Plate with Frame - 2 Module | 656 | 10/100   |

#### Mounting Accessories for Panel

|         |                                   |     |          |
|---------|-----------------------------------|-----|----------|
| 5760 15 | Panel Mounting Support - 1 Module | 414 | 1/10/100 |
| 5760 16 | Panel Mounting Support - 2 Module | 440 | 1/10/100 |
| 5760 50 | DIN Rail Support - 2 Module       | 522 | 1/10/100 |

### Square - Magnesium Mechanism

#### Switches - 6A - 230V AC

|         |  |     |          |
|---------|--|-----|----------|
| 5736 00 | 6A - Switch - SP - 1 Way - 1 Module                  | 272 | 1/20/200 |
| 5736 01 | 6A - Switch - SP - 1 Way - with Indicator - 1 Module | 492 | 1/20/200 |

## Arteor™

### Square Magnesium Mechanism

| Cat.Nos | Description | MRP*<br>₹ / Unit | Pack |
|---------|-------------|------------------|------|
|---------|-------------|------------------|------|

#### Switches - 6A - 230V AC

|         |  |     |          |
|---------|--|-----|----------|
| 5736 02 | 6A - Switch - SP - 2 Way - 1 Module                  | 444 | 1/20/200 |
| 5736 03 | 6A - Switch - SP - 2 Way - with Indicator - 1 Module | 630 | 1/20/200 |

#### Switches - 10A - 230V AC

|         |  |      |          |
|---------|--|------|----------|
| 5736 50 | 10A - Switch - SP - 1 Way - 2 Module                                 | 488  | 1/10/100 |
| 5736 51 | 10A - Switch - SP - 2 Way - 2 Module                                 | 574  | 1/10/100 |
| 5725 37 | 10A - Switch - SP - 2 Way - with Indicator & Label Holder - 2 Module | 2876 | 1/5/50   |
| 5725 38 | 10A - Intermediate Switch - 230V AC - 2 Module                       | 3516 | 1/10/100 |

#### Switches - 20A - 230V AC

|         |  |      |          |
|---------|--|------|----------|
| 5736 10 | 20A - Switch - SP - 1 Way - 1 Module   | 590  | 1/20/200 |
| 5736 52 | 20A - Switch - SP - 1 Way - 2 Module   | 694  | 1/10/100 |
| 5725 63 | 20A - Switch - SP - 1 Way - with Indicator - 1 Module                        | 620  | 1/20/200 |
| 5736 11 | 20A - Switch - SP - 2 Way - with Indicator - 1 Module                        | 850  | 1/20/200 |
| 5725 42 | 20A - Switch - SP - 2 Way - with Indicator - 2 Module                        | 910  | 1/5/50   |
| 5725 43 | 20A - Switch - 3 Gang - 1 Way - 2 Module                                     | 1682 | 1/10/100 |
| 5725 44 | 20A - Switch - 3 Gang - 2*2 Way + 1*1 Way - 2 Module                         | 1756 | 1/10/100 |
| 5736 54 | 20A - Switch - DP - 1 Way - with Indicator - 2 Module                        | 1360 | 1/10/100 |
| 5725 49 | 20A - Switch - DP - 1 Way - with Indicator & Water Heater Marking - 2 Module | 1452 | 1/10/100 |

#### Switches - 25A - 230V AC

|         |  |     |          |
|---------|--|-----|----------|
| 5736 17 | 25A - Switch - 1 Way - with Indicator - 1 Module | 782 | 1/20/200 |
|---------|--|-----|----------|

#### Switches - 32A - 230V AC

|         |   |      |          |
|---------|---|------|----------|
| 5736 12 | 32A - Switch - DP - 1 Way - with Indicator - 2 Module | 1896 | 1/10/100 |
|---------|---|------|----------|

#### Push Button - 6A - 230V AC

|         |   |     |          |
|---------|---|-----|----------|
| 5736 13 | 6A - Bell Push - SP - 1 Way - 1 Module                    | 472 | 1/20/200 |
| 5736 59 | 6A - Bell Push - SP - 1 Way - 2 Module                    | 674 | 1/10/100 |
| 5736 04 | 6A - Push Button - SP - 1 Way - 1 Module                  | 490 | 1/20/200 |
| 5736 05 | 6A - Push Button - SP - 1 Way - with Indicator - 1 Module | 654 | 1/20/200 |

\* MRP - Maximum Retail Price Inclusive of all taxes including GST.

**Bold Cat.Nos** are products normally available with Legrand (India) Stockists. **Cat.Nos** that are not bold - delivery within 4 - 8 weeks from the date of order. **Bold packing quantity** is our mandatory packing. Orders to be placed by Legrand (India) Stockist in multiples of the same.

## Arteor™

### Square Magnesium Mechanism

| Cat.Nos | Description | MRP*<br>₹ / Unit | Pack |
|---------|-------------|------------------|------|
|---------|-------------|------------------|------|

#### Push Button – 6A - 230V AC

|         |   |     |          |
|---------|---|-----|----------|
| 5736 14 | 6A - Bell Push - SP - 1 Way - with Indicator - 1 Module | 650 | 1/20/200 |
| 5736 60 | 6A - Bell Push - SP - 1 Way - with Indicator - 2 Module | 908 | 1/10/100 |

#### Electric Roller Blinds Control

|         |   |      |          |
|---------|---|------|----------|
| 5727 20 | Double Switch for Electric Shutter - 2 Module | 1190 | 1/10/100 |
|---------|---|------|----------|

#### Dimmers & Fan Regulators

|         |   |      |          |
|---------|---|------|----------|
| 5736 62 | Light Dimmer - 60 to 400 Watts - 2 Module                           | 1986 | 1/10/100 |
| 5736 16 | Fan Step Regulator - 100 Watts - ISI - 1 Module                     | 1632 | 1/5/50   |
| 5736 63 | Fan Step Regulator - 100 Watts - ISI - 2 Module                     | 2012 | 1/10/100 |
| 5736 69 | Fan Step Regulator - 120 Watts - ISI - 2 Module (for 48 & 56" Fans) | 2154 | 1/10/100 |
| 5736 68 | Fan Step Regulator - for Energy Saving Fans - 2 Module              | 2136 | 1/10/100 |
| 5736 56 | Fan Regulator - 8 Steps - 100 Watts - ISI - 2 Module                | 1910 | 1/10/100 |

#### Indian Standard Sockets

|         |   |      |          |
|---------|---|------|----------|
| 5736 24 | 6A - Socket - with Shutter - 3 Pin - ISI - 2 Module                 | 420  | 1/20/200 |
| 5736 71 | 6/16A - Socket - with Shutter - 3 Pin - Indian - ISI - 2 Module     | 824  | 1/10/100 |
| 5736 67 | 6/16A - Socket - with Shutter - 3 Pin - Indian - ISI - 3 Module     | 1004 | 1/5/50   |
| 5737 10 | 16A - Socket Shutter with Switch - 3 Pin - 2P+E - Indian - 3 Module | 2320 | 5/50     |

#### USB Chargers (IS13252 (Part 1) / IEC 60950-1)

|         |   |      |          |
|---------|---|------|----------|
| 5734 44 | USB Charger - 1500mA - Type A - 1 Module          | 3140 | 1/5/50   |
| 5716 81 | USB Charger - 3000mA/15 Watts - Type A - 1 Module | 3532 | 1/10/150 |

## Arteor™

### Square Magnesium Mechanism

| Cat.Nos | Description | MRP*<br>₹ / Unit | Pack |
|---------|-------------|------------------|------|
|---------|-------------|------------------|------|

#### USB Chargers (IS13252 (Part 1) / IEC 60950-1)

|                     |   |       |          |
|---------------------|---|-------|----------|
| 5716 85             | USB Charger - 3000mA/15 Watts - Type A + A - 1 Module           | 4028  | 1/10/150 |
| 5716 89             | USB Charger - 3000mA/15 Watts - Type A + C - 1 Module           | 4620  | 1/10/150 |
| 5716 93             | USB Charger - 3000mA/15 Watts - Type C + C - 1 Module           | 5048  | 1/10/150 |
| 5716 97             | USB Charger - Power Delivery - 20 Watts - Type C - 1 Module     | 6638  | 1/10/150 |
| 5734 82             | USB Charger - Power Delivery - 30 Watts - Type C + C - 2 Module | 9698  | 1/20     |
| 5754 82             | USB Charger - Power Delivery - 45 Watts - Type C - 2 Module     | 12514 | 1/20     |
| <b>NEW!</b> 5754 95 | USB Charger - Power Delivery - 65 Watts - Type C + C - 3 Module | 15328 | 1/20     |

#### Data & Voice

|         |   |      |          |
|---------|---|------|----------|
| 5736 27 | Telephone Socket - Double RJ11 - 1 Module           | 742  | 1/20/200 |
| 5736 26 | Telephone Socket - RJ11 - with Shutter - 1 Module   | 448  | 1/20/200 |
| 5736 29 | Information Socket - RJ45 - Cat 5E - UTP - 1 Module | 846  | 1/20/200 |
| 5736 28 | Information Socket - RJ45 - Cat 6 - UTP - 1 Module  | 1290 | 1/20/200 |
| 5736 74 | Information Socket - RJ45 - Cat 6 - UTP - 2 Module  | 1360 | 1/10/100 |

#### TV Sockets

|         |                                 |     |          |
|---------|---------------------------------|-----|----------|
| 5736 25 | TV Co - axial Socket - 1 Module | 460 | 1/20/200 |
|---------|---------------------------------|-----|----------|

#### Electronic Chime

|         |                                  |     |          |
|---------|----------------------------------|-----|----------|
| 5736 43 | Bell Ding Dong - 230V - 2 Module | 736 | 1/10/100 |
|---------|----------------------------------|-----|----------|

#### Buzzer

|         |                          |      |          |
|---------|--------------------------|------|----------|
| 5736 42 | Buzzer - 230V - 1 Module | 1994 | 1/20/200 |
|---------|--------------------------|------|----------|

#### Bell Call Indicator & Register - 6A - 230V AC

|         |  |      |          |
|---------|--|------|----------|
| 5736 15 | 6A - Bell Call Indicator - SP - with Register - 1 Way - 1 Module | 3042 | 1/20/200 |
|---------|--|------|----------|

\* MRP - Maximum Retail Price Inclusive of all taxes including GST.  
Red Cat. Nos - New Products

Bold Cat.Nos are products normally available with Legrand (India) Stockists. Cat.Nos that are not bold - delivery within 4 - 8 weeks from the date of order. Bold packing quantity is our mandatory packing. Orders to be placed by Legrand (India) Stockist in multiples of the same.

## Arteor™

### Square Magnesium Mechanism

| Cat.Nos | Description | MRP*<br>₹ / Unit | Pack |
|---------|-------------|------------------|------|
|---------|-------------|------------------|------|

#### Lighting

|         |  |       |          |
|---------|--|-------|----------|
| 5735 64 | Skirting Light - with LED - 230V - 3 Module            | 1638  | 1/10/100 |
| 5727 26 | Skirting Light - with Detector (LED) - 230V - 2 Module | 21352 | 1/20     |

#### Hospitality Function

##### Hotel "DND and MMR " functions

|         |   |      |          |
|---------|---|------|----------|
| 5736 61 | External DND & MMR Control Unit - with Bell Push - 2 Module | 3250 | 1/5/50   |
| 5736 58 | Internal DND & MMR Control Unit - 2 Module                  | 2352 | 1/10/100 |

#### Hotel Keycard Switch

|         |   |      |       |
|---------|---|------|-------|
| 5727 44 | 16A - Key Card Switch - 230V - with Time Delay - 2 Module | 8532 | 1/10  |
| 5727 59 | Key Fob for Key Card Switch                               | 2934 | 10/50 |

#### Shaver Socket

|         |  |      |   |
|---------|--|------|---|
| 5726 53 | Shaver Socket - 230V/120 - 230V - with Earth Connector | 8870 | 1 |
|---------|--|------|---|

#### Time Switch

|         |                              |       |      |
|---------|------------------------------|-------|------|
| 5740 84 | Time Delay Switch - 2 Module | 10574 | 1/20 |
|---------|------------------------------|-------|------|

#### Audio - Video Connector

|         |  |       |      |
|---------|--|-------|------|
| 5727 72 | Double RCA Socket (Audio) - 1 Module         | 7564  | 1/20 |
| 5727 73 | Triple RCA Socket (Audio & Video) - 1 Module | 5901  | 1/20 |
| 5727 74 | Female 3.5mm Jack - 1 Module                 | 6712  | 1/20 |
| 5727 76 | Female BNC 75 Jack - 1 Module                | 6528  | 1/20 |
| 5727 83 | Female XLR Jack - 2 Module                   | 11737 | 1/20 |
| 5725 97 | Preterminated Sockets Female Hd15 - 1 Module | 9255  | 1    |
| 5725 96 | Preterminated HDMI Socket - 1.4 - 1 Module   | 10494 | 1    |
| 5727 84 | Line Dying Down - 100V (25 - 30W) - 2 Module | 18788 | 1    |

\* MRP - Maximum Retail Price Inclusive of all taxes including GST.

## Arteor™

### Square Magnesium Mechanism

| Cat.Nos | Description | MRP*<br>₹ / Unit | Pack |
|---------|-------------|------------------|------|
|---------|-------------|------------------|------|

#### Audio - Video Connector

|         |                                     |      |      |
|---------|-------------------------------------|------|------|
| 5727 75 | USB Socket - 1 Module               | 5245 | 1/20 |
| 5727 88 | Female HD15 + Jack 3.5mm - 2 Module | 7365 | 1/20 |

#### Blanking Plate

|         |                           |     |          |
|---------|---------------------------|-----|----------|
| 5736 49 | Blanking Plate - 1 Module | 70  | 1/40/400 |
| 5728 44 | Blanking Plate - 2 Module | 122 | 1/10/100 |

#### Dedicated Switches

|         |  |      |          |
|---------|--|------|----------|
| 5738 02 | 20A - Dedicated Switch - DP - 1 Way - 1 Module - Red | 1366 | 1/10/100 |
|---------|--|------|----------|

#### Tamper Proof & Dedicated Sockets

|         |   |      |          |
|---------|---|------|----------|
| 5738 10 | 16A - Dedicated Socket with Switch - 3 Pin - 2P+E - Indian - 3 Module | 2842 | 1/10/100 |
|---------|---|------|----------|

#### Square - Champagne Mechanism

##### Switches - 6A - 230V AC

|         |  |     |          |
|---------|--|-----|----------|
| 5748 00 | 6A - Switch - SP - 1 Way - 1 Module                  | 272 | 1/20/200 |
| 5748 01 | 6A - Switch - SP - 1 Way - with Indicator - 1 Module | 492 | 1/20/200 |
| 5748 02 | 6A - Switch - SP - 2 Way - 1 Module                  | 444 | 1/20/200 |
| 5748 03 | 6A - Switch - SP - 2 Way - with Indicator - 1 Module | 630 | 1/20/200 |

##### Switches - 10A - 230V AC

|         |  |      |          |
|---------|--|------|----------|
| 5748 04 | 10A - Switch - SP - 1 Way - 2 Module                                 | 488  | 1/10/100 |
| 5748 05 | 10A - Switch - SP - 2 Way - 2 Module                                 | 574  | 1/10/100 |
| 5748 06 | 10A - Switch - SP - 2 Way - with Indicator & Label Holder - 2 Module | 2876 | 1/10/100 |
| 5748 07 | 10A - Intermediate Switch - 230V AC - 2 Module                       | 3516 | 1/10/100 |

##### Switches - 20A - 230V AC

|         |   |     |          |
|---------|---|-----|----------|
| 5748 08 | 20A - Switch - SP - 1 Way - 1 Module                  | 590 | 1/20/200 |
| 5748 09 | 20A - Switch - SP - 1 Way - 2 Module                  | 694 | 1/10/100 |
| 5748 10 | 20A - Switch - SP - 1 Way - with Indicator - 1 Module | 620 | 1/20/200 |
| 5748 11 | 20A - Switch - SP - 2 Way - with Indicator - 1 Module | 850 | 1/20/200 |

**Bold Cat.Nos** are products normally available with Legrand (India) Stockists. **Cat.Nos** that are not bold - delivery within 4 - 8 weeks from the date of order. **Bold packing quantity** is our mandatory packing. Orders to be placed by Legrand (India) Stockist in multiples of the same.

## Arteor™

### Square Champagne Mechanism

| Cat.Nos | Description | MRP*<br>₹ / Unit | Pack |
|---------|-------------|------------------|------|
|---------|-------------|------------------|------|

#### Switches – 20A - 230V AC

|         |  |      |          |
|---------|--|------|----------|
| 5748 12 | 20A - Switch - SP - 2 Way - with Indicator - 2 Module                        | 910  | 1/10/100 |
| 5748 13 | 20A - Switch - 3 Gang - 1 Way - 2 Module                                     | 1680 | 1/10/100 |
| 5748 14 | 20A - Switch - 3 Gang - 2*2 Way + 1*1 Way - 2 Module                         | 1756 | 1/10/100 |
| 5748 15 | 20A - Switch - DP - 1 Way - with Indicator - 2 Module                        | 1360 | 1/10/100 |
| 5748 16 | 20A - Switch - DP - 1 Way - with Indicator & Water Heater Marking - 2 Module | 1452 | 1/10/100 |

#### Switches – 25A - 230V AC

|         |  |     |          |
|---------|--|-----|----------|
| 5748 17 | 25A - Switch - 1 Way - with Indicator - 1 Module | 782 | 1/20/200 |
|---------|--|-----|----------|

#### Switches – 32A / 40A - 230V AC

|         |   |      |          |
|---------|---|------|----------|
| 5748 18 | 32A - Switch - DP - 1 Way - with Indicator - 2 Module               | 1896 | 1/10/100 |
| 5748 19 | 40A - Switch - DP - 1 Way - with Indicator - fits on 1/2 Module Box | 2180 | 1/5/20   |

#### Push Button – 6A - 230V AC

|         |   |     |          |
|---------|---|-----|----------|
| 5748 23 | 6A - Bell Push - SP - 1 Way - 1 Module                    | 472 | 1/20/200 |
| 5748 24 | 6A - Bell Push - SP - 1 Way - 2 Module                    | 674 | 1/10/100 |
| 5748 21 | 6A - Push Button - SP - 1 Way - 1 Module                  | 490 | 1/20/200 |
| 5748 22 | 6A - Push Button - SP - 1 Way - with Indicator - 1 Module | 654 | 1/20/200 |
| 5748 25 | 6A - Bell Push - SP - 1 Way - with Indicator - 1 Module   | 650 | 1/20/200 |
| 5748 26 | 6A - Bell Push - SP - 1 Way - with Indicator - 2 Module   | 908 | 1/10/100 |

#### Electric Roller Blinds Control

|         |   |      |          |
|---------|---|------|----------|
| 5748 20 | Double Switch for Electric Shutter - 2 Module | 1190 | 1/10/100 |
|---------|---|------|----------|

#### Dimmers & Fan Regulators

|         |   |      |          |
|---------|---|------|----------|
| 5748 27 | Light Dimmer - 60 to 400 Watts - 2 Module                           | 2042 | 10/100   |
| 5748 29 | Fan Step Regulator - 100 Watts - ISI - 1 Module                     | 1632 | 1/5/50   |
| 5748 30 | Fan Step Regulator - 100 Watts - ISI - 2 Module                     | 2012 | 1/10/100 |
| 5748 31 | Fan Step Regulator - 120 Watts - ISI - 2 Module (for 48 & 56" Fans) | 2154 | 1/10/100 |
| 5748 32 | Fan Step Regulator - for Energy Saving Fans - 2 Module              | 2136 | 1/10/100 |

## Arteor™

### Square Champagne Mechanism

| Cat.Nos | Description | MRP*<br>₹ / Unit | Pack |
|---------|-------------|------------------|------|
|---------|-------------|------------------|------|

|         |  |      |          |
|---------|--|------|----------|
| 5736 57 | Fan Regulator - 8 Steps - 100 Watts - ISI - 2 Module | 1910 | 1/10/100 |
|---------|--|------|----------|

#### Indian Standard Sockets

|         |   |      |          |
|---------|---|------|----------|
| 5748 84 | 6A - Socket - with Shutter - 3 Pin - ISI - 2 Module             | 420  | 1/20/200 |
| 5748 34 | 6/16A - Socket - with Shutter - 3 Pin - Indian - ISI - 2 Module | 824  | 1/10/100 |
| 5748 35 | 6/16A - Socket - with Shutter - 3 Pin - Indian - ISI - 3 Module | 1004 | 1/5/50   |

#### USB Chargers (IS13252 (part 1) / IEC 60950-1)

|                |   |       |          |
|----------------|---|-------|----------|
| 5734 47        | USB Charger - 1500mA - Type A - 1 Module                        | 3140  | 1/5/50   |
| 5716 82        | USB Charger - 3000mA/15 Watts - Type A - 1 Module               | 3532  | 1/10/150 |
| 5716 86        | USB Charger - 3000mA/15 Watts - Type A + A - 1 Module           | 4028  | 1/10/150 |
| 5716 90        | USB Charger - 3000mA/15 Watts - Type A + C - 1 Module           | 4620  | 1/10/150 |
| 5716 94        | USB Charger - 3000mA/15 Watts - Type C + C - 1 Module           | 5048  | 1/10/150 |
| 5716 98        | USB Charger - Power Delivery - 20 Watts - Type C - 1 Module     | 6638  | 1/10/150 |
| 5734 83        | USB Charger - Power Delivery - 30 Watts - Type C + C - 2 Module | 9698  | 1/20     |
| 5754 83        | USB Charger - Power Delivery - 45 Watts - Type C - 2 Module     | 12514 | 1/20     |
| <b>5754 96</b> | USB Charger - Power Delivery - 65 Watts - Type C + C - 3 Module | 15328 | 1/20     |

#### Data & Voice

|         |   |      |          |
|---------|---|------|----------|
| 5748 45 | Telephone Socket - Double RJ11 - 1 Module           | 742  | 1/20/200 |
| 5748 46 | Telephone Socket - RJ11 - with Shutter - 1 Module   | 448  | 1/20/200 |
| 5748 47 | Information Socket - RJ45 - Cat 5E - UTP - 1 Module | 846  | 1/20/200 |
| 5748 48 | Information Socket - RJ45 - Cat 5E - UTP - 2 Module | 909  | 1/10/100 |
| 5748 49 | Information Socket - RJ45 - Cat 6 - UTP - 1 Module  | 1290 | 1/20/200 |
| 5748 50 | Information Socket - RJ45 - Cat 6 - UTP - 2 Module  | 1360 | 1/10/100 |

#### TV Sockets

|         |                                 |     |          |
|---------|---------------------------------|-----|----------|
| 5748 51 | TV Co - axial Socket - 1 Module | 460 | 1/20/200 |
|---------|---------------------------------|-----|----------|

#### Electronic Chime

|         |                                  |     |          |
|---------|----------------------------------|-----|----------|
| 5748 52 | Bell Ding Dong - 230V - 2 Module | 736 | 1/10/100 |
|---------|----------------------------------|-----|----------|

\* MRP - Maximum Retail Price Inclusive of all taxes including GST.  
Red Cat. Nos - New Products

Bold Cat.Nos are products normally available with Legrand (India) Stockists. Cat.Nos that are not bold - delivery within 4 - 8 weeks from the date of order. Bold packing quantity is our mandatory packing. Orders to be placed by Legrand (India) Stockist in multiples of the same.

## Arteor™

### Square Champagne Mechanism

| Cat.Nos | Description | MRP*<br>₹ / Unit | Pack |
|---------|-------------|------------------|------|
|---------|-------------|------------------|------|

#### Buzzer

|         |                          |      |          |
|---------|--------------------------|------|----------|
| 5748 53 | Buzzer - 230V - 1 Module | 1994 | 1/20/200 |
|---------|--------------------------|------|----------|

#### Bell Call Indicator & Register - 6A - 230V AC

|         |  |      |          |
|---------|--|------|----------|
| 5748 54 | 6A - Bell Call Indicator - SP - with Register - 1 Way - 1 Module | 3042 | 1/20/200 |
|---------|--|------|----------|

#### Lighting

|         |   |      |          |
|---------|---|------|----------|
| 5748 55 | Skirting Light - with LED - 230V - 3 Module | 1638 | 1/10/100 |
|---------|---|------|----------|

#### Hospitality Function

##### Hotel "DND and MMR" Functions

|         |   |      |          |
|---------|---|------|----------|
| 5748 56 | External DND & MMR Control Unit - with Bell Push - 2 Module | 3250 | 1/5/50   |
| 5748 57 | Internal DND & MMR Control Unit - 2 Module                  | 2352 | 1/10/100 |

##### Hotel Keycard Switch

|         |   |      |        |
|---------|---|------|--------|
| 5748 58 | 16A - Key Card Switch - 230V - with Time Delay - 2 Module | 8410 | 1/0/10 |
| 5727 59 | Key Fob for Key Card Switch                               | 2934 | 10/50  |

#### Blanking Plate

|         |                           |     |          |
|---------|---------------------------|-----|----------|
| 5748 63 | Blanking Plate - 1 Module | 70  | 1/40/400 |
| 5748 64 | Blanking Plate - 2 Module | 122 | 1/10/100 |

#### Round - White Mechanism

##### Switches - 6A - 230V AC

|         |  |     |          |
|---------|--|-----|----------|
| 5733 00 | 6A - Switch - SP - 1 Way - Left - 1 Module                   | 346 | 1/20/200 |
| 5733 01 | 6A - Switch - SP - 1 Way - Right - 1 Module                  | 346 | 1/20/200 |
| 5733 12 | 6A - Switch - SP - 1 Way - Middle - 1 Module                 | 346 | 1/20/200 |
| 5733 05 | 6A - Switch - SP - 2 Way - Left - 1 Module                   | 458 | 1/20/200 |
| 5733 06 | 6A - Switch - SP - 2 Way - Right - 1 Module                  | 458 | 1/20/200 |
| 5733 02 | 6A - Switch - SP - 1 Way - with Indicator - Left - 1 Module  | 522 | 1/20/200 |
| 5733 04 | 6A - Switch - SP - 1 Way - with Indicator - Right - 1 Module | 522 | 1/20/200 |

## Arteor™

### Round White Mechanism

| Cat.Nos | Description | MRP*<br>₹ / Unit | Pack |
|---------|-------------|------------------|------|
|---------|-------------|------------------|------|

#### Switches - 6A - 230V AC

|         |   |     |          |
|---------|---|-----|----------|
| 5733 03 | 6A - Switch - SP - 1 Way - with Indicator - Middle - 1 Module | 522 | 1/20/200 |
| 5733 07 | 6A - Switch - SP - 2 Way - with Indicator - Left - 1 Module   | 652 | 1/20/200 |
| 5733 08 | 6A - Switch - SP - 2 Way - with Indicator - Right - 1 Module  | 652 | 1/20/200 |

#### Switches - 20A - 230V AC

|         |   |      |          |
|---------|---|------|----------|
| 5733 20 | 20A - Switch - SP - 1 Way - Left - 1 Module                   | 626  | 1/20/200 |
| 5733 21 | 20A - Switch - SP - 1 Way - Right - 1 Module                  | 626  | 1/20/200 |
| 5730 21 | 20A - Switch - SP - 1 Way - Middle - 1 Module                 | 642  | 1/10/100 |
| 5733 40 | 20A - Switch - SP - 1 Way - 2 Module                          | 732  | 1/10/100 |
| 5720 64 | 20A - Switch - SP - 1 Way - with Indicator - Left - 1 Module  | 648  | 1/20/200 |
| 5720 65 | 20A - Switch - SP - 1 Way - with Indicator - Right - 1 Module | 648  | 1/20/200 |
| 5730 24 | 20A - Switch - SP - 2 Way - Middle - 1 Module                 | 650  | 1/10/100 |
| 5733 22 | 20A - Switch - SP - 2 Way - with Indicator - Left - 1 Module  | 896  | 1/20/200 |
| 5733 23 | 20A - Switch - SP - 2 Way - with Indicator - Right - 1 Module | 896  | 1/20/200 |
| 5730 71 | 20A - Switch - SP - 2 Way - with Indicator - 2 Module         | 798  | 1/5/50   |
| 5730 72 | 20A - Switch - 3 Gang - 1 Way - 2 Module                      | 1754 | 1/10/100 |
| 5730 73 | 20A - Switch - 3 Gang - 2*2 Way + 1*1 Way - 2 Module          | 1932 | 1/10/100 |
| 5733 42 | 20A - Switch - DP - 1 Way - with Indicator - 2 Module         | 1360 | 1/10/100 |

#### Switches - 32A - 230V AC

|         |   |      |          |
|---------|---|------|----------|
| 5733 26 | 32A - Switch - DP - 1 Way - with Indicator - 2 Module | 1982 | 1/10/100 |
|---------|---|------|----------|

#### Push Button - 6A - 230V AC

|         |   |     |          |
|---------|---|-----|----------|
| 5733 31 | 6A - Bell Push - SP - 1 Way - Right - 1 Module          | 490 | 1/20/200 |
| 5733 30 | 6A - Bell Push - SP - 1 Way - Left - 1 Module           | 490 | 1/20/200 |
| 5733 46 | 6A - Bell Push - SP - 1 Way - 2 Module                  | 696 | 1/10/100 |
| 5733 47 | 6A - Bell Push - SP - 1 Way - with Indicator - 2 Module | 946 | 1/10/100 |

#### Electronic Roller Blinds Control

|         |   |      |          |
|---------|---|------|----------|
| 5732 20 | Double Switch For Electric Shutter - 2 Module | 1240 | 1/10/100 |
|---------|---|------|----------|

\* MRP - Maximum Retail Price Inclusive of all taxes including GST.

Bold Cat.Nos are products normally available with Legrand (India) Stockists. Cat.Nos that are not bold - delivery within 4 - 8 weeks from the date of order. Bold packing quantity is our mandatory packing. Orders to be placed by Legrand (India) Stockist in multiples of the same.

## Arteor™

### Round White Mechanism



5730 66

| Cat.Nos | Description | MRP*<br>₹ / Unit | Pack |
|---------|-------------|------------------|------|
|---------|-------------|------------------|------|

#### Dimmers & Fan Regulators

|         |  |      |          |
|---------|--|------|----------|
| 5730 66 | Light Dimmer - 60 to 400 Watts - 2 Module              | 2068 | 1/10/100 |
| 5730 03 | Fan Step Regulator - 100 Watts - ISI - 2 Module        | 2096 | 1/10/100 |
| 5730 69 | Fan Step Regulator - 120 Watts - ISI - 2 Module        | 2272 | 1/10/100 |
| 5730 04 | Fan Step Regulator - for Energy Saving Fans - 2 Module | 2224 | 1/10/100 |

#### Indian Standard Sockets

|         |   |     |          |
|---------|---|-----|----------|
| 5734 94 | 6A - Socket - with Shutter - 3 Pin - ISI - 2 Module | 748 | 1/20/200 |
|---------|---|-----|----------|

#### Data & Voice



5723 24

|         |  |      |        |
|---------|--|------|--------|
| 5723 24 | Information Socket - RJ45 - Cat 6 - UTP - 2 Module | 1513 | 10/100 |
|---------|--|------|--------|

#### Hotel "DND & MMR" Functions



5720 74

|         |   |      |        |
|---------|---|------|--------|
| 5720 74 | Internal DND & MMR Control Unit - 2 Module                  | 2848 | 1/5/50 |
| 5720 67 | External DND & MMR Control Unit - with Bell Push - 2 Module | 3578 | 5/40   |

#### Blanking Plate



5730 87

|         |                           |     |          |
|---------|---------------------------|-----|----------|
| 5730 87 | Blanking Plate - 2 Module | 124 | 1/10/100 |
|---------|---------------------------|-----|----------|

#### Round - Magnesium Mechanism

##### Switches - 6A - 230V AC



5733 50



5733 51



5733 62

|         |   |     |          |
|---------|---|-----|----------|
| 5733 50 | 6A - Switch - SP - 1 Way - Left - 1 Module                  | 400 | 1/20/200 |
| 5733 51 | 6A - Switch - SP - 1 Way - Right - 1 Module                 | 400 | 1/20/200 |
| 5733 62 | 6A - Switch - SP - 1 Way - Middle - 1 Module                | 402 | 1/20/200 |
| 5733 55 | 6A - Switch - SP - 2 Way - Left - 1 Module                  | 528 | 1/20/200 |
| 5733 56 | 6A - Switch - SP - 2 Way - Right - 1 Module                 | 528 | 1/20/200 |
| 5733 52 | 6A - Switch - SP - 1 Way - with Indicator - Left - 1 Module | 586 | 1/20/200 |



5733 70



5733 71



5733 72



5733 92



5733 76



5733 81



5733 80

## Arteor™

### Round Magnesium Mechanism

| Cat.Nos | Description | MRP*<br>₹ / Unit | Pack |
|---------|-------------|------------------|------|
|---------|-------------|------------------|------|

#### Switches - 6A - 230V AC

|         |  |     |          |
|---------|--|-----|----------|
| 5733 54 | 6A - Switch - SP - 1 Way - with Indicator - Right - 1 Module | 586 | 1/20/200 |
| 5733 57 | 6A - Switch - SP - 2 Way - with Indicator - Left - 1 Module  | 756 | 1/20/200 |
| 5733 58 | 6A - Switch - SP - 2 Way - with Indicator - Right - 1 Module | 756 | 1/20/200 |

#### Switches - 20A - 230V AC

|         |  |      |          |
|---------|--|------|----------|
| 5733 70 | 20A - Switch - SP - 1 Way - Left - 1 Module                    | 698  | 1/20/200 |
| 5733 71 | 20A - Switch - SP - 1 Way - Right - 1 Module                   | 698  | 1/20/200 |
| 5731 21 | 20A - Switch - SP - 1 Way - Middle - 1 Module                  | 698  | 1/10/100 |
| 5733 90 | 20A - Switch - SP - 1 Way - 2 Module                           | 830  | 1/10/100 |
| 5725 64 | 20A - Switch - SP - 1 Way - with Indicator - Left - 1 Module   | 732  | 1/20/200 |
| 5725 65 | 20A - Switch - SP - 1 Way - with Indicator - Right - 1 Module  | 732  | 1/20/200 |
| 5731 24 | 20A - Switch - SP - 2 Way - Middle - 1 Module                  | 744  | 1/10/100 |
| 5733 72 | 20A - Switch - SP - 2 Way - with Indicator - Left - 1 Module   | 1014 | 1/20/200 |
| 5733 73 | 20A - Switch - SP - 2 Way - with Indicator - Right - 1 Module  | 1014 | 1/20/200 |
| 5731 71 | 20A - Switch - SP - 2 Way - with Indicator - 2 Module          | 962  | 1/5/50   |
| 5731 72 | 20A - Switch - 3 Gang - 1 Way - 2 Module                       | 2014 | 1/5/50   |
| 5731 73 | 20A - Switch - 3 Gang - 2*2 Way + 1*1 Way - 2 Module           | 2124 | 1/5/50   |
| 5733 92 | 20A - Switch - DP - 1 Way - with Indicator - 2 Module          | 1572 | 1/10/100 |
| 5731 27 | 20A - Switch - SP - 2 Way - with Indicator - Middle - 1 Module | 1016 | 1/5/50   |

#### Switches - 32A - 230V AC

|         |   |      |          |
|---------|---|------|----------|
| 5733 76 | 32A - Switch - DP - 1 Way - with Indicator - 2 Module | 2270 | 1/10/100 |
|---------|---|------|----------|

#### Push Button - 6A - 230V AC

|         |   |      |          |
|---------|---|------|----------|
| 5733 81 | 6A - Bell Push - SP - 1 Way - Right - 1 Module          | 574  | 1/20/200 |
| 5733 80 | 6A - Bell Push - SP - 1 Way - Left - 1 Module           | 574  | 1/20/200 |
| 5733 96 | 6A - Bell Push - SP - 1 Way - 2 Module                  | 816  | 1/10/100 |
| 5733 97 | 6A - Bell Push - SP - 1 Way - with Indicator - 2 Module | 1072 | 1/10/100 |

\* MRP - Maximum Retail Price Inclusive of all taxes including GST.

**Bold Cat.Nos** are products normally available with Legrand (India) Stockists. **Cat.Nos** that are not bold - delivery within 4 - 8 weeks from the date of order. **Bold packing quantity** is our mandatory packing. Orders to be placed by Legrand (India) Stockist in multiples of the same.

## Arteor™

### Round Magnesium Mechanism

| Cat.Nos | Description | MRP*<br>₹ / Unit | Pack |
|---------|-------------|------------------|------|
|---------|-------------|------------------|------|

#### Electronic Roller Blinds Control

|         |   |      |          |
|---------|---|------|----------|
| 5737 20 | Double Switch for Electric Shutter - 2 Module | 1434 | 1/10/100 |
|---------|---|------|----------|

#### Dimmers & Fan Regulators

|         |  |      |          |
|---------|--|------|----------|
| 5733 66 | Light Dimmer - 60 to 400 Watts - 2 Module              | 2396 | 1/10/100 |
| 5731 03 | Fan Step Regulator - 100 Watts - ISI - 2 Module        | 2410 | 1/10/100 |
| 5731 69 | Fan Step Regulator - 120 Watts - ISI - 2 Module        | 2598 | 1/10/100 |
| 5731 04 | Fan Step Regulator - for Energy Saving Fans - 2 Module | 2570 | 1/10/100 |



5731 03

#### Indian Standard Sockets

|         |   |     |          |
|---------|---|-----|----------|
| 5736 94 | 6A - Socket - with Shutter - 3 Pin - ISI - 2 Module | 864 | 1/20/200 |
|---------|---|-----|----------|



5728 24

#### Data & Voice

|         |  |      |        |
|---------|--|------|--------|
| 5728 24 | Information Socket - RJ45 - Cat 6 - UTP - 2 Module | 1727 | 10/100 |
|---------|--|------|--------|



5725 74

#### Hotel "DND and MMR" Functions

|         |   |      |        |
|---------|---|------|--------|
| 5725 74 | Internal DND & MMR Control Unit - 2 Module                  | 3264 | 1/5/50 |
| 5725 67 | External DND & MMR Control Unit - with Bell Push - 2 Module | 3906 | 5/40   |



5725 67

#### Blanking Plate

|         |                           |     |          |
|---------|---------------------------|-----|----------|
| 5731 87 | Blanking Plate - 2 Module | 146 | 1/10/100 |
|---------|---------------------------|-----|----------|



5731 87

#### Round - Champagne Mechanism

##### Switches - 6A - 230V AC

|         |   |     |          |
|---------|---|-----|----------|
| 5749 00 | 6A - Switch - SP - 1 Way - Left - 1 Module                    | 400 | 1/20/200 |
| 5749 01 | 6A - Switch - SP - 1 Way - Right - 1 Module                   | 400 | 1/20/200 |
| 5749 02 | 6A - Switch - SP - 1 Way - Middle - 1 Module                  | 400 | 1/20/200 |
| 5749 03 | 6A - Switch - SP - 2 Way - Left - 1 Module                    | 528 | 1/20/200 |
| 5749 04 | 6A - Switch - SP - 2 Way - Right - 1 Module                   | 528 | 1/20/200 |
| 5749 05 | 6A - Switch - SP - 1 Way - with Indicator - Left - 1 Module   | 586 | 1/20/200 |
| 5749 06 | 6A - Switch - SP - 1 Way - with Indicator - Right - 1 Module  | 586 | 1/20/200 |
| 5749 07 | 6A - Switch - SP - 1 Way - with Indicator - Middle - 1 Module | 586 | 1/20/200 |



5749 00



5749 01



5749 02



5749 03

## Arteor™

### Round Champagne Mechanism

| Cat.Nos | Description | MRP*<br>₹ / Unit | Pack |
|---------|-------------|------------------|------|
|---------|-------------|------------------|------|

|         |  |     |          |
|---------|--|-----|----------|
| 5749 08 | 6A - Switch - SP - 2 Way - with Indicator - Left - 1 Module  | 756 | 1/20/200 |
| 5749 09 | 6A - Switch - SP - 2 Way - with Indicator - Right - 1 Module | 756 | 1/20/200 |

#### Switches - 20A - 230V AC

|         |   |      |          |
|---------|---|------|----------|
| 5749 10 | 20A - Switch - SP - 1 Way - Left - 1 Module                   | 698  | 1/20/200 |
| 5749 11 | 20A - Switch - SP - 1 Way - Right - 1 Module                  | 698  | 1/20/200 |
| 5749 12 | 20A - Switch - SP - 1 Way - Middle - 1 Module                 | 698  | 1/20/200 |
| 5749 13 | 20A - Switch - SP - 1 Way - 2 Module                          | 830  | 1/10/200 |
| 5749 14 | 20A - Switch - SP - 1 Way - with Indicator - Left - 1 Module  | 732  | 1/20/200 |
| 5749 15 | 20A - Switch - SP - 1 Way - with Indicator - Right - 1 Module | 732  | 1/20/200 |
| 5749 16 | 20A - Switch - SP - 2 Way - Middle - 1 Module                 | 742  | 1/20/200 |
| 5749 17 | 20A - Switch - SP - 2 Way - with Indicator - Left - 1 Module  | 1016 | 1/20/200 |
| 5749 18 | 20A - Switch - SP - 2 Way - with Indicator - Right - 1 Module | 1016 | 1/20/200 |
| 5749 19 | 20A - Switch - SP - 2 Way - with Indicator - 2 Module         | 962  | 1/10/100 |
| 5749 20 | 20A - Switch - 3 Gang - 1 Way - 2 Module                      | 2014 | 1/10/100 |
| 5749 21 | 20A - Switch - 3 Gang - 2*2 Way + 1*1 Way - 2 Module          | 2124 | 1/10/100 |
| 5749 22 | 20A - Switch - DP - 1 Way - with Indicator - 2 Module         | 1572 | 1/10/100 |



5749 16



5749 17



5749 18



5749 22

#### Push Button - 6A - 230V AC

|         |   |      |          |
|---------|---|------|----------|
| 5749 23 | 6A - Bell Push - SP - 1 Way - Right - 1 Module          | 574  | 1/20/200 |
| 5749 24 | 6A - Bell Push - SP - 1 Way - Left - 1 Module           | 574  | 1/20/200 |
| 5749 25 | 6A - Bell Push - SP - 1 Way - 2 Module                  | 816  | 1/10/100 |
| 5749 26 | 6A - Bell Push - SP - 1 Way - with Indicator - 2 Module | 1072 | 1/10/100 |



5749 26

#### Dimmers & Fan Regulators

|         |  |      |          |
|---------|--|------|----------|
| 5749 27 | Light Dimmer - 60 to 400 Watts - 2 Module              | 2476 | 10/100   |
| 5749 29 | Fan Step Regulator - 100 Watts - ISI - 2 Module        | 2410 | 1/10/100 |
| 5749 30 | Fan Step Regulator - 120 Watts - ISI - 2 Module        | 2598 | 1/10/100 |
| 5749 31 | Fan Step Regulator - for Energy Saving Fans - 2 Module | 2570 | 1/10/100 |



5749 27



5749 29

\* MRP - Maximum Retail Price Inclusive of all taxes including GST.

**Bold Cat.Nos** are products normally available with Legrand (India) Stockists. **Cat.Nos** that are not bold - delivery within 4 - 8 weeks from the date of order. **Bold packing quantity** is our mandatory packing. Orders to be placed by Legrand (India) Stockist in multiples of the same.

## Arteor™

### Square Cover Plates with Metal Frame

| Cat.Nos | Description | MRP*<br>₹ / Unit | Pack |
|---------|-------------|------------------|------|
|---------|-------------|------------------|------|

#### Indian Standard Sockets

|         |   |     |          |
|---------|---|-----|----------|
| 5749 94 | 6A - Socket - with Shutter - 3 Pin - ISI - 2 Module | 864 | 1/20/200 |
|---------|---|-----|----------|

#### Blanking Plate

|         |                           |     |        |
|---------|---------------------------|-----|--------|
| 5749 64 | Blanking Plate - 2 Module | 146 | 10/100 |
|---------|---------------------------|-----|--------|

#### Square Cover Plates with Metal Frame White Cover Plates with Metal Frame

|         |  |      |        |
|---------|--|------|--------|
| 5757 00 | Cover Plate - 1 Module - White                   | 326  | 10/100 |
| 5757 10 | Cover Plate - 2 Module - White                   | 344  | 10/100 |
| 5757 20 | Cover Plate - 3 Module - White                   | 386  | 10/100 |
| 5757 30 | Cover Plate - 4 Module - White                   | 404  | 5/50   |
| 5757 40 | Cover Plate - 6 Module - White                   | 738  | 5/30   |
| 5757 50 | Cover Plate - 8 Module - White                   | 820  | 5/30   |
| 5757 60 | Cover Plate - 2*4 Module - White                 | 1034 | 2/20   |
| 5757 70 | Cover Plate - 2*6 Module - White                 | 1264 | 2/16   |
| 5757 80 | Cover Plate - 2*8 Module - White                 | 1514 | 2/16   |
| 5757 90 | Cover Plate - 3*6 Module - White                 | 1676 | 2/12   |
| 5758 00 | Cover Plate - 3*8 Module - White                 | 2002 | 2/12   |
| 5750 70 | Cover Plate - for Shaver Socket-3 Module - White | 574  | 5/50   |

#### Pearl Aluminium Cover Plates with Metal Frame

|         |  |      |          |
|---------|--|------|----------|
| 5759 73 | Cover Plate - 1 Module - Pearl Aluminium   | 488  | 10/100   |
| 5759 74 | Cover Plate - 2 Module - Pearl Aluminium   | 506  | 1/10/100 |
| 5759 75 | Cover Plate - 3 Module - Pearl Aluminium   | 548  | 10/100   |
| 5759 76 | Cover Plate - 4 Module - Pearl Aluminium   | 620  | 5/50     |
| 5759 77 | Cover Plate - 6 Module - Pearl Aluminium   | 1068 | 5/30     |
| 5759 78 | Cover Plate - 8 Module - Pearl Aluminium   | 1170 | 1/5/30   |
| 5759 79 | Cover Plate - 2*4 Module - Pearl Aluminium | 1492 | 2/20     |
| 5759 80 | Cover Plate - 2*6 Module - Pearl Aluminium | 1934 | 1/2/16   |
| 5759 81 | Cover Plate - 2*8 Module - Pearl Aluminium | 2188 | 2/16     |
| 5759 82 | Cover Plate - 3*6 Module - Pearl Aluminium | 2560 | 2/12     |
| 5759 83 | Cover Plate - 3*8 Module - Pearl Aluminium | 2914 | 2/12     |

#### Graphite Cover Plates with Metal Frame

|         |                                   |      |          |
|---------|-----------------------------------|------|----------|
| 5759 61 | Cover Plate - 1 Module - Graphite | 488  | 10/100   |
| 5759 62 | Cover Plate - 2 Module - Graphite | 506  | 1/10/100 |
| 5759 63 | Cover Plate - 3 Module - Graphite | 548  | 10/100   |
| 5759 64 | Cover Plate - 4 Module - Graphite | 620  | 5/50     |
| 5759 66 | Cover Plate - 6 Module - Graphite | 1068 | 5/30     |

## Arteor™

### Square Cover Plates with Metal Frame

| Cat.Nos | Description | MRP*<br>₹ / Unit | Pack |
|---------|-------------|------------------|------|
|---------|-------------|------------------|------|

#### Graphite Cover Plates with Metal Frame

|         |                                     |      |        |
|---------|-------------------------------------|------|--------|
| 5759 67 | Cover Plate - 8 Module - Graphite   | 1170 | 1/5/30 |
| 5759 68 | Cover Plate - 2*4 Module - Graphite | 1492 | 2/20   |
| 5759 69 | Cover Plate - 2*6 Module - Graphite | 1934 | 1/2/16 |
| 5759 70 | Cover Plate - 2*8 Module - Graphite | 2188 | 2/16   |
| 5759 71 | Cover Plate - 3*6 Module - Graphite | 2560 | 2/12   |
| 5759 72 | Cover Plate - 3*8 Module - Graphite | 2914 | 2/12   |

#### Magnesium Cover Plates with Metal Frame

|         |                                      |      |          |
|---------|--------------------------------------|------|----------|
| 5755 89 | Cover Plate - 1 Module - Magnesium   | 488  | 10/100   |
| 5755 90 | Cover Plate - 2 Module - Magnesium   | 506  | 1/10/100 |
| 5755 91 | Cover Plate - 3 Module - Magnesium   | 548  | 10/100   |
| 5755 93 | Cover Plate - 4 Module - Magnesium   | 620  | 5/50     |
| 5755 94 | Cover Plate - 6 Module - Magnesium   | 1068 | 1/5/30   |
| 5755 95 | Cover Plate - 8 Module - Magnesium   | 1170 | 1/5/30   |
| 5755 96 | Cover Plate - 2*4 Module - Magnesium | 1492 | 1/2/20   |
| 5755 97 | Cover Plate - 2*6 Module - Magnesium | 1934 | 1/2/16   |
| 5755 98 | Cover Plate - 2*8 Module - Magnesium | 2188 | 2/16     |
| 5755 99 | Cover Plate - 3*6 Module - Magnesium | 2560 | 2/12     |

#### Champagne Cover Plates with Metal Frame

|         |                                      |      |          |
|---------|--------------------------------------|------|----------|
| 5759 84 | Cover Plate - 1 Module - Champagne   | 488  | 10/100   |
| 5759 85 | Cover Plate - 2 Module - Champagne   | 506  | 1/10/100 |
| 5759 86 | Cover Plate - 3 Module - Champagne   | 548  | 10/100   |
| 5759 87 | Cover Plate - 4 Module - Champagne   | 620  | 5/50     |
| 5759 88 | Cover Plate - 6 Module - Champagne   | 1068 | 5/30     |
| 5759 89 | Cover Plate - 8 Module - Champagne   | 1170 | 1/5/30   |
| 5759 90 | Cover Plate - 2*4 Module - Champagne | 1492 | 2/20     |
| 5759 91 | Cover Plate - 2*6 Module - Champagne | 1934 | 1/2/16   |
| 5759 92 | Cover Plate - 2*8 Module - Champagne | 2188 | 2/16     |
| 5759 93 | Cover Plate - 3*6 Module - Champagne | 2560 | 2/12     |

#### Dark Bronze Cover Plates with Metal Frame

|         |                                      |     |          |
|---------|--------------------------------------|-----|----------|
| 5756 79 | Cover Plate - 1 Module - Dark Bronze | 488 | 10/100   |
| 5756 80 | Cover Plate - 2 Module - Dark Bronze | 506 | 1/10/100 |
| 5756 81 | Cover Plate - 3 Module - Dark Bronze | 548 | 10/100   |

\* MRP - Maximum Retail Price Inclusive of all taxes including GST.

**Bold Cat.Nos** are products normally available with Legrand (India) Stockists. **Cat.Nos that are not bold** - delivery within 4 - 8 weeks from the date of order. **Bold packing quantity** is our mandatory packing. Orders to be placed by Legrand (India) Stockist in multiples of the same.

## Arteor™

### Square Cover Plates with Metal Frame

| Cat.Nos  | Description                            | MRP*<br>₹ / Unit | Pack   |
|--|--|------------------|--------|
| <b>Dark Bronze Cover Plates with Metal Frame</b> |  |                  |        |
| 5756 83  | Cover Plate - 4 Module - Dark Bronze   | 620              | 5/50   |
| 5756 84  | Cover Plate - 6 Module - Dark Bronze   | 1068             | 5/30   |
| 5756 85  | Cover Plate - 8 Module - Dark Bronze   | 1170             | 1/5/30 |
| 5756 86  | Cover Plate - 2*4 Module - Dark Bronze | 1492             | 2/20   |
| 5756 87  | Cover Plate - 2*6 Module - Dark Bronze | 1934             | 1/2/16 |
| 5756 88  | Cover Plate - 2*8 Module - Dark Bronze | 2188             | 2/16   |
| 5756 89  | Cover Plate - 3*6 Module - Dark Bronze | 2560             | 2/12   |

### Pearl Aluminium Cover Plates with Overmoulded Frame

|         |  |      |        |
|---------|--|------|--------|
| 5757 01 | Cover Plate - 1 Module - Pearl Aluminium                   | 540  | 10/100 |
| 5757 11 | Cover Plate - 2 Module - Pearl Aluminium                   | 572  | 10/100 |
| 5757 21 | Cover Plate - 3 Module - Pearl Aluminium                   | 608  | 10/100 |
| 5757 31 | Cover Plate - 4 Module - Pearl Aluminium                   | 690  | 5/50   |
| 5757 41 | Cover Plate - 6 Module - Pearl Aluminium                   | 1172 | 5/30   |
| 5757 51 | Cover Plate - 8 Module - Pearl Aluminium                   | 1302 | 5/30   |
| 5757 61 | Cover Plate - 2*4 Module - Pearl Aluminium                 | 1652 | 2/20   |
| 5757 71 | Cover Plate - 2*6 Module - Pearl Aluminium                 | 2146 | 2/16   |
| 5757 81 | Cover Plate - 2*8 Module - Pearl Aluminium                 | 2438 | 2/16   |
| 5757 91 | Cover Plate - 3*6 Module - Pearl Aluminium                 | 2852 | 2/12   |
| 5758 01 | Cover Plate - 3*8 Module - Pearl Aluminium                 | 3236 | 2/12   |
| 5750 71 | Cover Plate - for Shaver Socket-3 Module - Pearl Aluminium | 920  | 5/50   |

### Graphite Cover Plates with Overmoulded Frame

|         |                                     |      |        |
|---------|-------------------------------------|------|--------|
| 5757 02 | Cover Plate - 1 Module - Graphite   | 540  | 10/100 |
| 5757 12 | Cover Plate - 2 Module - Graphite   | 572  | 10/100 |
| 5757 22 | Cover Plate - 3 Module - Graphite   | 608  | 10/100 |
| 5757 32 | Cover Plate - 4 Module - Graphite   | 690  | 5/50   |
| 5757 42 | Cover Plate - 6 Module - Graphite   | 1172 | 5/30   |
| 5757 52 | Cover Plate - 8 Module - Graphite   | 1302 | 5/30   |
| 5757 62 | Cover Plate - 2*4 Module - Graphite | 1652 | 2/20   |
| 5757 72 | Cover Plate - 2*6 Module - Graphite | 2146 | 2/16   |

## Arteor™

### Square Cover Plates

| Cat.Nos   | Description   | MRP*<br>₹ / Unit | Pack |
|---|---|------------------|------|
| <b>Graphite Cover Plates with Overmoulded Frame</b> |   |                  |      |
| 5757 82   | Cover Plate - 2*8 Module - Graphite                 | 2438             | 2/16 |
| 5757 92   | Cover Plate - 3*6 Module - Graphite                 | 2852             | 2/12 |
| 5758 02   | Cover Plate - 3*8 Module - Graphite                 | 3238             | 2/12 |
| 5750 72   | Cover Plate - for Shaver Socket-3 Module - Graphite | 920              | 5/50 |

### Magnesium Cover Plates with Overmoulded Frame

|         |  |      |        |
|---------|--|------|--------|
| 5758 11 | Cover Plate - 1 Module - Magnesium                   | 540  | 10/100 |
| 5758 12 | Cover Plate - 2 Module - Magnesium                   | 572  | 10/100 |
| 5758 13 | Cover Plate - 3 Module - Magnesium                   | 608  | 10/100 |
| 5758 14 | Cover Plate - 4 Module - Magnesium                   | 690  | 1/5/50 |
| 5758 15 | Cover Plate - 6 Module - Magnesium                   | 1172 | 5/30   |
| 5758 16 | Cover Plate - 8 Module - Magnesium                   | 1302 | 5/30   |
| 5758 17 | Cover Plate - 2*4 Module - Magnesium                 | 1652 | 2/20   |
| 5758 18 | Cover Plate - 2*6 Module - Magnesium                 | 2146 | 2/16   |
| 5758 19 | Cover Plate - 2*8 Module - Magnesium                 | 2438 | 2/16   |
| 5758 20 | Cover Plate - 3*6 Module - Magnesium                 | 2852 | 2/12   |
| 5758 21 | Cover Plate - for Shaver Socket-3 Module - Magnesium | 924  | 5/50   |

### Champagne Cover Plates with Overmoulded Frame

|         |  |      |        |
|---------|--|------|--------|
| 5758 22 | Cover Plate - 1 Module - Champagne                   | 540  | 10/100 |
| 5758 23 | Cover Plate - 2 Module - Champagne                   | 572  | 10/100 |
| 5758 24 | Cover Plate - 3 Module - Champagne                   | 608  | 10/100 |
| 5758 25 | Cover Plate - 4 Module - Champagne                   | 690  | 5/50   |
| 5758 26 | Cover Plate - 6 Module - Champagne                   | 1172 | 5/30   |
| 5758 27 | Cover Plate - 8 Module - Champagne                   | 1302 | 5/30   |
| 5758 28 | Cover Plate - 2*4 Module - Champagne                 | 1652 | 2/20   |
| 5758 29 | Cover Plate - 2*6 Module - Champagne                 | 2146 | 2/16   |
| 5758 30 | Cover Plate - 2*8 Module - Champagne                 | 2438 | 2/16   |
| 5758 31 | Cover Plate - 3*6 Module - Champagne                 | 2852 | 2/12   |
| 5758 32 | Cover Plate - for Shaver Socket-3 Module - Champagne | 924  | 5/50   |

\* MRP - Maximum Retail Price Inclusive of all taxes including GST.

**Bold Cat.Nos** are products normally available with Legrand (India) Stockists. **Cat.Nos that are not bold** - delivery within 4 - 8 weeks from the date of order. **Bold packing quantity** is our mandatory packing. Orders to be placed by Legrand (India) Stockist in multiples of the same.

## Arteor™

### Square Cover Plates

| Cat.Nos  | Description  | MRP*<br>₹ / Unit | Pack   |
|--|--|------------------|--------|
| <b>Dark Bronze Cover Plates with Overmoulded Frame</b> |  |                  |        |
| 5758 33  | Cover Plate - 1 Module - Dark Bronze                   | 540              | 10/100 |
| 5758 34  | Cover Plate - 2 Module - Dark Bronze                   | 572              | 10/100 |
| 5758 35  | Cover Plate - 3 Module - Dark Bronze                   | 608              | 10/100 |
| 5758 36  | Cover Plate - 4 Module - Dark Bronze                   | 690              | 5/50   |
| 5758 37  | Cover Plate - 6 Module - Dark Bronze                   | 1172             | 5/30   |
| 5758 38  | Cover Plate - 8 Module - Dark Bronze                   | 1302             | 5/30   |
| 5758 39  | Cover Plate - 2*4 Module - Dark Bronze                 | 1652             | 2/20   |
| 5758 40  | Cover Plate - 2*6 Module - Dark Bronze                 | 2146             | 2/16   |
| 5758 41  | Cover Plate - 2*8 Module - Dark Bronze                 | 2438             | 2/16   |
| 5758 42  | Cover Plate - 3*6 Module - Dark Bronze                 | 2852             | 2/12   |
| 5758 43  | Cover Plate - for Shaver Socket-3 Module - Dark Bronze | 924              | 5/50   |

### Mirror Finish Cover Plates with Overmoulded Frame Mirror Black Cover Plates with Overmoulded Frame

|         |   |       |        |
|---------|---|-------|--------|
| 5757 03 | Cover Plate - 1 Module - Mirror Black   | 2756  | 1/5/30 |
| 5757 13 | Cover Plate - 2 Module - Mirror Black   | 2948  | 1/5/30 |
| 5757 23 | Cover Plate - 3 Module - Mirror Black   | 3158  | 1/20   |
| 5757 33 | Cover Plate - 4 Module - Mirror Black   | 3354  | 1/20   |
| 5757 43 | Cover Plate - 6 Module - Mirror Black   | 6106  | 1/5    |
| 5757 53 | Cover Plate - 8 Module - Mirror Black   | 6726  | 1/5    |
| 5757 63 | Cover Plate - 2*4 Module - Mirror Black | 8524  | 1/10   |
| 5757 73 | Cover Plate - 2*6 Module - Mirror Black | 10486 | 1/8    |

### Mirror White Cover Plates with Overmoulded Frame

|         |   |       |        |
|---------|---|-------|--------|
| 5757 04 | Cover Plate - 1 Module - Mirror White   | 2756  | 1/5/30 |
| 5757 14 | Cover Plate - 2 Module - Mirror White   | 2948  | 1/5/30 |
| 5757 24 | Cover Plate - 3 Module - Mirror White   | 3158  | 1/20   |
| 5757 34 | Cover Plate - 4 Module - Mirror White   | 3354  | 1/20   |
| 5757 44 | Cover Plate - 6 Module - Mirror White   | 6106  | 1/5    |
| 5757 54 | Cover Plate - 8 Module - Mirror White   | 6726  | 1/5    |
| 5757 64 | Cover Plate - 2*4 Module - Mirror White | 8680  | 1/10   |
| 5757 74 | Cover Plate - 2*6 Module - Mirror White | 10486 | 1/8    |

## Arteor™

### Square Cover Plates

| Cat.Nos   | Description  | MRP*<br>₹ / Unit | Pack   |
|---|--|------------------|--------|
| <b>Mirror Green Apple Cover Plates with Overmoulded Frame</b> |  |                  |        |
| 5758 44   | Cover Plate - 1 Module - Green Apple                   | 2756             | 1/5/30 |
| 5758 45   | Cover Plate - 2 Module - Green Apple                   | 2948             | 1/5/30 |
| 5758 46   | Cover Plate - 3 Module - Green Apple                   | 3158             | 1/20   |
| 5758 47   | Cover Plate - 4 Module - Green Apple                   | 3354             | 1/20   |
| 5758 48   | Cover Plate - 6 Module - Green Apple                   | 6106             | 1/5    |
| 5758 49   | Cover Plate - 8 Module - Green Apple                   | 6726             | 1/5    |
| 5758 50   | Cover Plate - 2*4 Module - Green Apple                 | 8678             | 1/10   |
| 5758 51   | Cover Plate - 2*6 Module - Green Apple                 | 10486            | 1/8    |
| 5758 52   | Cover Plate - for Shaver Socket-3 Module - Green Apple | 4598             | 1/5/50 |

### Graphic Casual Cover Plates with Overmoulded Frame

|         |   |       |        |
|---------|---|-------|--------|
| 5762 91 | Cover Plate - 1 Module - Graphic Casual   | 3346  | 1/5/30 |
| 5763 11 | Cover Plate - 2 Module - Graphic Casual   | 3600  | 1/5/30 |
| 5763 31 | Cover Plate - 3 Module - Graphic Casual   | 3868  | 1/20   |
| 5763 51 | Cover Plate - 4 Module - Graphic Casual   | 4128  | 1/20   |
| 5763 81 | Cover Plate - 6 Module - Graphic Casual   | 7474  | 1/5    |
| 5764 01 | Cover Plate - 8 Module - Graphic Casual   | 8244  | 1/5    |
| 5758 89 | Cover Plate - 2*4 Module - Graphic Casual | 10380 | 1/10   |
| 5758 90 | Cover Plate - 2*6 Module - Graphic Casual | 12850 | 1/8    |

### Silver Baroque Cover Plates with Overmoulded Frame

|         |   |      |        |
|---------|---|------|--------|
| 5758 53 | Cover Plate - 1 Module - Silver Baroque | 3346 | 1/5/30 |
| 5758 54 | Cover Plate - 2 Module - Silver Baroque | 3600 | 1/5/30 |
| 5758 55 | Cover Plate - 3 Module - Silver Baroque | 3868 | 1/0/20 |
| 5758 56 | Cover Plate - 4 Module - Silver Baroque | 4128 | 1/0/20 |
| 5758 57 | Cover Plate - 6 Module - Silver Baroque | 7474 | 1/0/5  |

\* MRP - Maximum Retail Price Inclusive of all taxes including GST.

**Bold Cat.Nos** are products normally available with Legrand (India) Stockists. **Cat.Nos that are not bold** - delivery within 4 - 8 weeks from the date of order. **Bold packing quantity** is our mandatory packing. Orders to be placed by Legrand (India) Stockist in multiples of the same.

## Arteor™

### Square Cover Plates

| Cat.Nos | Description   | MRP*<br>₹ / Unit | Pack   |
|---------|---|------------------|--------|
| 5758 58 | Cover Plate - 8 Module - Silver Baroque                   | 8244             | 1/0/5  |
| 5758 59 | Cover Plate - 2*4 Module - Silver Baroque                 | 10380            | 1/0/10 |
| 5758 60 | Cover Plate - 2*6 Module - Silver Baroque                 | 12850            | 1/0/8  |
| 5758 61 | Cover Plate - for Shaver Socket-3 Module - Silver Baroque | 5284             | 1/5/50 |

### Dark Baroque Cover Plates with Overmoulded Frame

|         |   |       |        |
|---------|---|-------|--------|
| 5758 62 | Cover Plate - 1 Module - Dark Baroque                   | 3346  | 1/5/30 |
| 5758 63 | Cover Plate - 2 Module - Dark Baroque                   | 3600  | 1/5/30 |
| 5758 64 | Cover Plate - 3 Module - Dark Baroque                   | 3868  | 1/0/20 |
| 5758 65 | Cover Plate - 4 Module - Dark Baroque                   | 4128  | 1/0/20 |
| 5758 66 | Cover Plate - 6 Module - Dark Baroque                   | 7474  | 1/0/5  |
| 5758 67 | Cover Plate - 8 Module - Dark Baroque                   | 8244  | 1/0/5  |
| 5758 68 | Cover Plate - 2*4 Module - Dark Baroque                 | 10378 | 1/0/10 |
| 5758 69 | Cover Plate - 2*6 Module - Dark Baroque                 | 12850 | 1/0/8  |
| 5758 70 | Cover Plate - for Shaver Socket-3 Module - Dark Baroque | 5284  | 1/5/50 |

### Metal Finish Cover Plates with Overmoulded Frame

#### Gold Brass Cover Plates with Overmoulded Frame

|         |                                     |       |        |
|---------|-------------------------------------|-------|--------|
| 5762 90 | Cover Plate - 1 Module - Gold Brass | 4492  | 1/5/30 |
| 5763 10 | Cover Plate - 2 Module - Gold Brass | 4808  | 1/5/30 |
| 5763 30 | Cover Plate - 3 Module - Gold Brass | 5172  | 1/0/20 |
| 5763 50 | Cover Plate - 4 Module - Gold Brass | 5486  | 1/0/20 |
| 5763 80 | Cover Plate - 6 Module - Gold Brass | 9986  | 1/0/5  |
| 5764 00 | Cover Plate - 8 Module - Gold Brass | 10976 | 1/0/5  |

\* MRP - Maximum Retail Price Inclusive of all taxes including GST.

## Arteor™

### Square Cover Plates

| Cat.Nos | Description | MRP*<br>₹ / Unit | Pack |
|---------|-------------|------------------|------|
|---------|-------------|------------------|------|

### Stainless Steel Cover Plates with Overmoulded Frame

|         |  |       |        |
|---------|--|-------|--------|
| 5757 06 | Cover Plate - 1 Module - Stainless Steel   | 4492  | 1/5/30 |
| 5757 16 | Cover Plate - 2 Module - Stainless Steel   | 4808  | 1/5/30 |
| 5757 26 | Cover Plate - 3 Module - Stainless Steel   | 5172  | 1/20   |
| 5757 36 | Cover Plate - 4 Module - Stainless Steel   | 5486  | 1/20   |
| 5757 46 | Cover Plate - 6 Module - Stainless Steel   | 9986  | 1/5    |
| 5757 56 | Cover Plate - 8 Module - Stainless Steel   | 10976 | 1/0/5  |
| 5757 66 | Cover Plate - 2*4 Module - Stainless Steel | 13878 | 1/0/10 |
| 5757 76 | Cover Plate - 2*6 Module - Stainless Steel | 17104 | 1/8    |

### Wood Cover Plates with Overmoulded Frame

|         |   |       |        |
|---------|---|-------|--------|
| 5758 80 | Cover Plate - 1 Module - Grey Oak                   | 2632  | 1/5/30 |
| 5758 81 | Cover Plate - 2 Module - Grey Oak                   | 2792  | 1/5/30 |
| 5758 82 | Cover Plate - 3 Module - Grey Oak                   | 3446  | 1/20   |
| 5758 83 | Cover Plate - 4 Module - Grey Oak                   | 3820  | 1/20   |
| 5758 84 | Cover Plate - 6 Module - Grey Oak                   | 5672  | 1/5    |
| 5758 85 | Cover Plate - 8 Module - Grey Oak                   | 6822  | 1/5    |
| 5758 86 | Cover Plate - 2*4 Module - Grey Oak                 | 8102  | 1/10   |
| 5758 87 | Cover Plate - 2*6 Module - Grey Oak                 | 10856 | 1/8    |
| 5758 88 | Cover Plate - for Shaver Socket-3 Module - Grey Oak | 3364  | 1/5/50 |

### Signature Cover Plates with Overmoulded Frame

|         |   |       |        |
|---------|---|-------|--------|
| 5758 71 | Cover Plate - 1 Module - Cube Plate                   | 8610  | 1/5/30 |
| 5758 72 | Cover Plate - 2 Module - Cube Plate                   | 8764  | 1/5/30 |
| 5758 73 | Cover Plate - 3 Module - Cube Plate                   | 10024 | 1/20   |
| 5758 74 | Cover Plate - 4 Module - Cube Plate                   | 10358 | 1/20   |
| 5758 75 | Cover Plate - 6 Module - Cube Plate                   | 13492 | 1/5    |
| 5758 76 | Cover Plate - 8 Module - Cube Plate                   | 14158 | 1/5    |
| 5758 77 | Cover Plate - 2*4 Module - Cube Plate                 | 21154 | 1/10   |
| 5758 78 | Cover Plate - 2*6 Module - Cube Plate                 | 23434 | 1/8    |
| 5758 79 | Cover Plate - for Shaver Socket-3 Module - Cube Plate | 9610  | 1/5/50 |

Bold Cat.Nos are products normally available with Legrand (India) Stockists. Cat.Nos that are not bold - delivery within 4 - 8 weeks from the date of order. Bold packing quantity is our mandatory packing. Orders to be placed by Legrand (India) Stockist in multiples of the same.

## Arteor™

### Round Cover Plates

| Cat.Nos | Description | MRP*<br>₹ / Unit | Pack |
|---------|-------------|------------------|------|
|---------|-------------|------------------|------|

#### Round Cover Plates with Metal Frame

##### Round - White Cover Plates with Metal Frame

|         |                                  |      |        |
|---------|----------------------------------|------|--------|
| 5759 00 | Cover Plate - 2 Module - White   | 498  | 10/100 |
| 5759 10 | Cover Plate - 3 Module - White   | 526  | 10/100 |
| 5759 20 | Cover Plate - 4 Module - White   | 554  | 5/50   |
| 5759 30 | Cover Plate - 6 Module - White   | 1012 | 5/30   |
| 5765 80 | Cover Plate - 8 Module - White   | 1118 | 5/30   |
| 5759 40 | Cover Plate - 2*4 Module - White | 1180 | 2/20   |
| 5759 50 | Cover Plate - 2*6 Module - White | 1720 | 2/16   |

##### Round - Pearl Aluminium Cover Plates with Metal Frame

|         |  |      |        |
|---------|--|------|--------|
| 5757 93 | Cover Plate - 2 Module - Pearl Aluminium   | 668  | 10/100 |
| 5757 94 | Cover Plate - 3 Module - Pearl Aluminium   | 722  | 10/100 |
| 5757 95 | Cover Plate - 4 Module - Pearl Aluminium   | 812  | 5/50   |
| 5757 96 | Cover Plate - 6 Module - Pearl Aluminium   | 1382 | 5/30   |
| 5757 97 | Cover Plate - 8 Module - Pearl Aluminium   | 1532 | 5/30   |
| 5757 98 | Cover Plate - 2*4 Module - Pearl Aluminium | 1932 | 2/20   |
| 5757 99 | Cover Plate - 2*6 Module - Pearl Aluminium | 2518 | 2/16   |

##### Round - Graphite Cover Plates with Metal Frame

|         |                                     |      |        |
|---------|-------------------------------------|------|--------|
| 5758 03 | Cover Plate - 2 Module - Graphite   | 668  | 10/100 |
| 5758 04 | Cover Plate - 3 Module - Graphite   | 722  | 10/100 |
| 5758 05 | Cover Plate - 4 Module - Graphite   | 812  | 5/50   |
| 5758 06 | Cover Plate - 6 Module - Graphite   | 1376 | 5/30   |
| 5758 07 | Cover Plate - 8 Module - Graphite   | 1532 | 5/30   |
| 5758 08 | Cover Plate - 2*4 Module - Graphite | 1932 | 2/20   |
| 5758 09 | Cover Plate - 2*6 Module - Graphite | 2518 | 2/16   |

##### Round - Magnesium Cover Plates with Metal Frame

|         |                                      |      |        |
|---------|--------------------------------------|------|--------|
| 5756 23 | Cover Plate - 2 Module - Magnesium   | 668  | 10/100 |
| 5756 24 | Cover Plate - 3 Module - Magnesium   | 722  | 10/100 |
| 5756 25 | Cover Plate - 4 Module - Magnesium   | 812  | 5/50   |
| 5756 26 | Cover Plate - 6 Module - Magnesium   | 1376 | 5/30   |
| 5756 27 | Cover Plate - 8 Module - Magnesium   | 1528 | 5/30   |
| 5756 28 | Cover Plate - 2*4 Module - Magnesium | 1932 | 2/20   |
| 5756 29 | Cover Plate - 2*6 Module - Magnesium | 2518 | 2/16   |



5759 00



5759 10



5759 30



5759 80



5759 50



5759 41



5759 22

## Arteor™

### Round Cover Plates

| Cat.Nos | Description | MRP*<br>₹ / Unit | Pack |
|---------|-------------|------------------|------|
|---------|-------------|------------------|------|

#### Round - Champagne Cover Plates with Metal Frame

|         |                                      |      |        |
|---------|--------------------------------------|------|--------|
| 5758 91 | Cover Plate - 2 Module - Champagne   | 668  | 10/100 |
| 5758 92 | Cover Plate - 3 Module - Champagne   | 722  | 10/100 |
| 5758 93 | Cover Plate - 4 Module - Champagne   | 812  | 5/50   |
| 5758 94 | Cover Plate - 6 Module - Champagne   | 1376 | 5/30   |
| 5758 95 | Cover Plate - 8 Module - Champagne   | 1532 | 5/30   |
| 5758 96 | Cover Plate - 2*4 Module - Champagne | 1934 | 2/20   |
| 5758 97 | Cover Plate - 2*6 Module - Champagne | 2518 | 2/16   |

#### Round - Dark Bronze Cover Plates with Metal Frame

|         |  |      |        |
|---------|--|------|--------|
| 5756 93 | Cover Plate - 2 Module - Dark Bronze   | 668  | 10/100 |
| 5756 94 | Cover Plate - 3 Module - Dark Bronze   | 722  | 10/100 |
| 5756 95 | Cover Plate - 4 Module - Dark Bronze   | 810  | 5/50   |
| 5756 96 | Cover Plate - 6 Module - Dark Bronze   | 1376 | 5/30   |
| 5756 97 | Cover Plate - 8 Module - Dark Bronze   | 1528 | 5/30   |
| 5756 98 | Cover Plate - 2*4 Module - Dark Bronze | 1932 | 2/20   |
| 5756 99 | Cover Plate - 2*6 Module - Dark Bronze | 2518 | 2/16   |

#### Round - Pearl Aluminium Cover Plates with Overmoulded frame

|         |  |      |        |
|---------|--|------|--------|
| 5759 01 | Cover Plate - 2 Module - Pearl Aluminium   | 754  | 10/100 |
| 5759 11 | Cover Plate - 3 Module - Pearl Aluminium   | 796  | 10/100 |
| 5759 21 | Cover Plate - 4 Module - Pearl Aluminium   | 842  | 5/50   |
| 5759 31 | Cover Plate - 6 Module - Pearl Aluminium   | 1532 | 5/30   |
| 5765 81 | Cover Plate - 8 Module - Pearl Aluminium   | 1684 | 5/30   |
| 5759 41 | Cover Plate - 2*4 Module - Pearl Aluminium | 1768 | 2/20   |
| 5759 51 | Cover Plate - 2*6 Module - Pearl Aluminium | 2616 | 2/16   |

#### Round - Graphite Cover Plates with Overmoulded Frame

|         |                                     |      |        |
|---------|-------------------------------------|------|--------|
| 5759 02 | Cover Plate - 2 Module - Graphite   | 754  | 10/100 |
| 5759 12 | Cover Plate - 3 Module - Graphite   | 796  | 10/100 |
| 5759 22 | Cover Plate - 4 Module - Graphite   | 842  | 5/50   |
| 5759 32 | Cover Plate - 6 Module - Graphite   | 1532 | 5/30   |
| 5765 82 | Cover Plate - 8 Module - Graphite   | 1684 | 5/30   |
| 5759 42 | Cover Plate - 2*4 Module - Graphite | 1768 | 2/20   |

\* MRP - Maximum Retail Price Inclusive of all taxes including GST.

Bold Cat.Nos are products normally available with Legrand (India) Stockists. Cat.Nos that are not bold - delivery within 4 - 8 weeks from the date of order. Bold packing quantity is our mandatory packing. Orders to be placed by Legrand (India) Stockist in multiples of the same.

## Arteor™

### Round Cover Plates

| Cat.Nos | Description | MRP*<br>₹ / Unit | Pack |
|---------|-------------|------------------|------|
|---------|-------------|------------------|------|

#### Round - Graphite Cover Plates with Overmoulded Frame

|         |                                     |      |      |
|---------|-------------------------------------|------|------|
| 5759 52 | Cover Plate - 2*6 Module - Graphite | 2616 | 2/16 |
|---------|-------------------------------------|------|------|

#### Round - Magnesium Cover Plates with Overmoulded Frame

|         |                                      |      |        |
|---------|--------------------------------------|------|--------|
| 5768 41 | Cover Plate - 2 Module - Magnesium   | 754  | 10/100 |
| 5768 42 | Cover Plate - 3 Module - Magnesium   | 796  | 10/100 |
| 5768 43 | Cover Plate - 4 Module - Magnesium   | 842  | 5/50   |
| 5768 44 | Cover Plate - 6 Module - Magnesium   | 1532 | 5/30   |
| 5768 45 | Cover Plate - 8 Module - Magnesium   | 1684 | 5/30   |
| 5768 46 | Cover Plate - 2*4 Module - Magnesium | 1768 | 2/20   |
| 5768 47 | Cover Plate - 2*6 Module - Magnesium | 2616 | 2/16   |

#### Round - Champagne Cover Plates with Overmoulded Frame

|         |                                      |      |        |
|---------|--------------------------------------|------|--------|
| 5768 48 | Cover Plate - 2 Module - Champagne   | 754  | 10/100 |
| 5768 49 | Cover Plate - 3 Module - Champagne   | 796  | 10/100 |
| 5768 50 | Cover Plate - 4 Module - Champagne   | 842  | 5/50   |
| 5768 51 | Cover Plate - 6 Module - Champagne   | 1532 | 5/30   |
| 5768 52 | Cover Plate - 8 Module - Champagne   | 1684 | 5/30   |
| 5768 53 | Cover Plate - 2*4 Module - Champagne | 1768 | 2/20   |
| 5768 54 | Cover Plate - 2*6 Module - Champagne | 2616 | 2/16   |

#### Round - Dark Bronze Cover Plates with Overmoulded Frame

|         |  |      |        |
|---------|--|------|--------|
| 5768 55 | Cover Plate - 2 Module - Dark Bronze   | 754  | 10/100 |
| 5768 56 | Cover Plate - 3 Module - Dark Bronze   | 796  | 10/100 |
| 5768 57 | Cover Plate - 4 Module - Dark Bronze   | 842  | 5/50   |
| 5768 58 | Cover Plate - 6 Module - Dark Bronze   | 1532 | 5/30   |
| 5768 59 | Cover Plate - 8 Module - Dark Bronze   | 1684 | 5/30   |
| 5768 60 | Cover Plate - 2*4 Module - Dark Bronze | 1768 | 2/20   |
| 5768 61 | Cover Plate - 2*6 Module - Dark Bronze | 2616 | 2/16   |

#### Round Mirror Finish Cover Plates

#### Round - Mirror Black Cover Plates with Overmoulded Frame

|         |                                       |      |        |
|---------|---------------------------------------|------|--------|
| 5759 03 | Cover Plate - 2 Module - Mirror Black | 3250 | 1/5/30 |
| 5759 13 | Cover Plate - 3 Module - Mirror Black | 3486 | 1/20   |

## Arteor™

### Round Cover Plates

| Cat.Nos | Description | MRP*<br>₹ / Unit | Pack |
|---------|-------------|------------------|------|
|---------|-------------|------------------|------|

#### Round Mirror Finish Cover Plates

#### Round - Mirror Black Cover Plates with Overmoulded Frame

|         |   |       |      |
|---------|---|-------|------|
| 5759 23 | Cover Plate - 4 Module - Mirror Black   | 3708  | 1/20 |
| 5759 33 | Cover Plate - 6 Module - Mirror Black   | 6708  | 1/5  |
| 5765 83 | Cover Plate - 8 Module - Mirror Black   | 7408  | 1/5  |
| 5759 43 | Cover Plate - 2*4 Module - Mirror Black | 8732  | 1/10 |
| 5759 53 | Cover Plate - 2*6 Module - Mirror Black | 11544 | 1/8  |

#### Round - Mirror White Cover Plates with Overmoulded Frame

|         |   |       |        |
|---------|---|-------|--------|
| 5759 04 | Cover Plate - 2 Module - Mirror White   | 3250  | 1/5/30 |
| 5759 14 | Cover Plate - 3 Module - Mirror White   | 3486  | 1/20   |
| 5759 24 | Cover Plate - 4 Module - Mirror White   | 3708  | 1/20   |
| 5759 34 | Cover Plate - 6 Module - Mirror White   | 6708  | 1/5    |
| 5765 84 | Cover Plate - 8 Module - Mirror White   | 7408  | 1/5    |
| 5759 44 | Cover Plate - 2*4 Module - Mirror White | 8914  | 1/10   |
| 5759 54 | Cover Plate - 2*6 Module - Mirror White | 11544 | 1/8    |

#### Round - Green Apple Cover Plates with Overmoulded Frame

|         |  |       |        |
|---------|--|-------|--------|
| 5768 62 | Cover Plate - 2 Module - Green Apple   | 3250  | 1/5/30 |
| 5768 63 | Cover Plate - 3 Module - Green Apple   | 3486  | 1/20   |
| 5768 64 | Cover Plate - 4 Module - Green Apple   | 3708  | 1/20   |
| 5768 65 | Cover Plate - 6 Module - Green Apple   | 6706  | 1/5    |
| 5768 66 | Cover Plate - 8 Module - Green Apple   | 7408  | 1/5    |
| 5768 67 | Cover Plate - 2*4 Module - Green Apple | 8910  | 1/10   |
| 5768 68 | Cover Plate - 2*6 Module - Green Apple | 11544 | 1/8    |

#### Round - Graphic Casual Cover Plates with Overmoulded Frame

|         |   |      |        |
|---------|---|------|--------|
| 5763 01 | Cover Plate - 2 Module - Graphic Casual | 3972 | 1/5/30 |
|---------|---|------|--------|

\* MRP - Maximum Retail Price Inclusive of all taxes including GST.

**Bold Cat.Nos** are products normally available with Legrand (India) Stockists. **Cat.Nos** that are not bold - delivery within 4 - 8 weeks from the date of order. **Bold packing quantity** is our mandatory packing. Orders to be placed by Legrand (India) Stockist in multiples of the same.

## Arteor™

### Round Cover Plates

| Cat.Nos | Description | MRP*<br>₹ / Unit | Pack |
|---------|-------------|------------------|------|
|---------|-------------|------------------|------|

#### Round - Graphic Casual Cover Plates with Overmoulded Frame

|         |   |       |      |
|---------|---|-------|------|
| 5763 21 | Cover Plate - 3 Module - Graphic Casual   | 4252  | 1/20 |
| 5763 41 | Cover Plate - 4 Module - Graphic Casual   | 4538  | 1/20 |
| 5763 61 | Cover Plate - 6 Module - Graphic Casual   | 8224  | 1/5  |
| 5763 91 | Cover Plate - 8 Module - Graphic Casual   | 9056  | 1/5  |
| 5768 97 | Cover Plate - 2*4 Module - Graphic Casual | 10864 | 1/10 |
| 5768 98 | Cover Plate - 2*6 Module - Graphic Casual | 14134 | 1/8  |

#### Round - Silver Baroque Cover Plates with Overmoulded Frame

|         |   |       |        |
|---------|---|-------|--------|
| 5768 69 | Cover Plate - 2 Module - Silver Baroque   | 3972  | 1/5/30 |
| 5768 70 | Cover Plate - 3 Module - Silver Baroque   | 4252  | 1/20   |
| 5768 71 | Cover Plate - 4 Module - Silver Baroque   | 4538  | 1/20   |
| 5768 72 | Cover Plate - 6 Module - Silver Baroque   | 8224  | 1/5    |
| 5768 73 | Cover Plate - 8 Module - Silver Baroque   | 9056  | 1/5    |
| 5768 74 | Cover Plate - 2*4 Module - Silver Baroque | 10864 | 1/10   |
| 5768 75 | Cover Plate - 2*6 Module - Silver Baroque | 14134 | 1/8    |

#### Round - Dark Baroque Cover Plates with Overmoulded Frame

|         |   |       |        |
|---------|---|-------|--------|
| 5768 76 | Cover Plate - 2 Module - Dark Baroque   | 3972  | 1/5/30 |
| 5768 77 | Cover Plate - 3 Module - Dark Baroque   | 4252  | 1/20   |
| 5768 78 | Cover Plate - 4 Module - Dark Baroque   | 4538  | 1/20   |
| 5768 79 | Cover Plate - 6 Module - Dark Baroque   | 8224  | 1/5    |
| 5768 80 | Cover Plate - 8 Module - Dark Baroque   | 9056  | 1/5    |
| 5768 81 | Cover Plate - 2*4 Module - Dark Baroque | 10864 | 1/10   |
| 5768 82 | Cover Plate - 2*6 Module - Dark Baroque | 14134 | 1/8    |

## Arteor™

### Round Cover Plates

| Cat.Nos | Description | MRP*<br>₹ / Unit | Pack |
|---------|-------------|------------------|------|
|---------|-------------|------------------|------|

#### Round - Gold Brass Cover Plates with Overmoulded Frame

|         |                                     |       |        |
|---------|-------------------------------------|-------|--------|
| 5763 00 | Cover Plate - 2 Module - Gold Brass | 5300  | 1/5/30 |
| 5763 20 | Cover Plate - 3 Module - Gold Brass | 5660  | 1/20   |
| 5763 40 | Cover Plate - 4 Module - Gold Brass | 6038  | 1/20   |
| 5763 60 | Cover Plate - 6 Module - Gold Brass | 10970 | 1/5    |
| 5763 90 | Cover Plate - 8 Module - Gold Brass | 12086 | 1/5    |

#### Round - Stainless Steel Cover Plates with Overmoulded Frame

|         |  |       |        |
|---------|--|-------|--------|
| 5759 06 | Cover Plate - 2 Module - Stainless Steel   | 5300  | 1/5/30 |
| 5759 16 | Cover Plate - 3 Module - Stainless Steel   | 5660  | 1/20   |
| 5759 26 | Cover Plate - 4 Module - Stainless Steel   | 6038  | 1/20   |
| 5759 36 | Cover Plate - 6 Module - Stainless Steel   | 10970 | 1/5    |
| 5765 86 | Cover Plate - 8 Module - Stainless Steel   | 12086 | 1/5    |
| 5759 46 | Cover Plate - 2*4 Module - Stainless Steel | 15280 | 1/10   |
| 5759 56 | Cover Plate - 2*6 Module - Stainless Steel | 18808 | 1/8    |

#### Round - Wood Cover Plates with Overmoulded Frame

|         |                                     |       |        |
|---------|-------------------------------------|-------|--------|
| 5768 90 | Cover Plate - 2 Module - Grey Oak   | 2790  | 1/5/30 |
| 5768 91 | Cover Plate - 3 Module - Grey Oak   | 4126  | 1/20   |
| 5768 92 | Cover Plate - 4 Module - Grey Oak   | 4280  | 1/20   |
| 5768 93 | Cover Plate - 6 Module - Grey Oak   | 6076  | 1/5    |
| 5768 94 | Cover Plate - 8 Module - Grey Oak   | 7404  | 1/5    |
| 5768 95 | Cover Plate - 2*4 Module - Grey Oak | 7912  | 1/10   |
| 5768 96 | Cover Plate - 2*6 Module - Grey Oak | 10124 | 1/8    |

\* MRP - Maximum Retail Price Inclusive of all taxes including GST.

**Bold Cat.Nos** are products normally available with Legrand (India) Stockists. **Cat.Nos that are not bold** - delivery within 4 - 8 weeks from the date of order. **Bold packing quantity** is our mandatory packing. Orders to be placed by Legrand (India) Stockist in multiples of the same.

## Arteor™

### Round Cover Plates

| Cat.Nos  | Description                           | MRP*<br>₹ / Unit | Pack   |
|--|---------------------------------------|------------------|--------|
| <b>Round - Signature Cover Plates with Overmoulded Frame</b> |                                       |                  |        |
| 5768 83  | Cover Plate - 2 Module - Cube Plate   | 8764             | 1/5/30 |
| 5768 84  | Cover Plate - 3 Module - Cube Plate   | 10652            | 1/20   |
| 5768 85  | Cover Plate - 4 Module - Cube Plate   | 10848            | 1/20   |
| 5768 86  | Cover Plate - 6 Module - Cube Plate   | 13886            | 1/5    |
| 5768 87  | Cover Plate - 8 Module - Cube Plate   | 14732            | 1/5    |
| 5768 88  | Cover Plate - 2*4 Module - Cube Plate | 20496            | 1/10   |
| 5768 89  | Cover Plate - 2*6 Module - Cube Plate | 23190            | 1/8    |



5768 84

### Accessories

#### Plastic Surface Boxes

|         |                                    |     |    |
|---------|------------------------------------|-----|----|
| 5734 91 | Plastic Surface Box - 1/2 Module   | 144 | 55 |
| 5735 20 | Plastic Surface Box - 3 Module     | 172 | 42 |
| 5735 70 | Plastic Surface Box - 4 Module     | 204 | 27 |
| 5735 71 | Plastic Surface Box - 6 Module     | 254 | 20 |
| 5723 94 | Plastic Surface Box - 8 Module     | 286 | 20 |
| 5735 74 | Plastic Surface Box - 2*4 Module   | 350 | 10 |
| 5735 72 | Plastic Surface Box - 12/16 Module | 900 | 11 |
| 5735 73 | Plastic Surface Box - 18/24 Module | 952 | 8  |



5735 70

\* MRP - Maximum Retail Price Inclusive of all taxes including GST.

## Arteor™

### Mounting Boxes

| Cat.Nos                  | Description                    | MRP*<br>₹ / Unit | Pack |
|--------------------------|--------------------------------|------------------|------|
| <b>Metal Flush Boxes</b> |                                |                  |      |
| 6890 07                  | Metal Flush Box - 1/2 Module   | 170              | 40   |
| 6890 08                  | Metal Flush Box - 3 Module     | 170              | 40   |
| 6890 09                  | Metal Flush Box - 4 Module     | 226              | 40   |
| 6890 10                  | Metal Flush Box - 6 Module     | 358              | 40   |
| 6890 42                  | Metal Flush Box - 8 Module     | 416              | 40   |
| 6890 31                  | Metal Flush Box - 2*4 Module   | 414              | 20   |
| 6890 11                  | Metal Flush Box - 12/16 Module | 624              | 10   |
| 6890 12                  | Metal Flush Box - 18/24 Module | 788              | 10   |



6890 08



6890 09



6890 12



6846 38



6806 12



6806 13

#### IP 55 Plexo Box & Accessories

|         |   |      |   |
|---------|---|------|---|
| 6846 38 | Grey Plexo Box & Adaptor with Transparent Flap-3 Module-IP 66 | 5620 | 1 |
|---------|---|------|---|

#### IP 55 Plexo Box with PVC Membrane

|         |   |      |    |
|---------|---|------|----|
| 6806 11 | Grey Plexo Box & Adaptor with PVC Membrane-1 Module | 1240 | 10 |
| 6806 12 | Grey Plexo Box & Adaptor with PVC Membrane-2 Module | 1266 | 10 |
| 6806 13 | Grey Plexo Box & Adaptor with PVC Membrane-3 Module | 1684 | 10 |
| 6806 14 | Grey Plexo Box & Adaptor with PVC Membrane-4 Module | 2526 | 5  |

**Bold Cat.Nos** are products normally available with Legrand (India) Stockists. **Cat.Nos** that are not bold - delivery within 4 - 8 weeks from the date of order. **Bold packing quantity** is our mandatory packing. Orders to be placed by Legrand (India) Stockist in multiples of the same.

## Arteor™

### Mounting Boxes

| Cat.Nos                                  | Description  | MRP*<br>₹ /<br>Unit | Pack |
|--|--|---------------------|------|
| <b>IP 55 Plexo Box with PVC Membrane</b> |  |                     |      |
| 6806 19                                  | Grey Plexo Box & Adaptor with PVC Membrane-2 Row*4 Module  | 4096                | 5    |
| 6806 33                                  | Grey Plexo Flush Adaptor with Membrane-3 Module Arteor Box | 1350                | 20   |

## Arteor™

### Guarantee

- The Company, at its discretion, will replace products if they have any manufacturing defect within 10 years for switches (without LED lamp) and power sockets. For all other **Arteor™** wiring accessories the guarantee will be 2 years.
- The above guarantee is applicable when the devices are used in Legrand metal flush boxes. Otherwise the guarantee period will be reduced by 50%.
- The guarantee is only applicable when the products are installed as per the Company's instructions and not tampered in any manner.
- The guarantee states the Company's entire liability. It does not extend to cover consequential loss or damage or installation costs arising from defective products.

Our switches are compliant with revised BIS standard (IS 3854:2023) requirements. Also, our switches are covered additionally for use on Self-Ballasted Lamp (SBL) loads.

#### SBL power rating as per IS3854:2023

| Switch Rating           | 6A, 230V~ | 10A, 230V~ | 16A, 230V~ | 20A, 230V~ |
|-------------------------|-----------|------------|------------|------------|
| <b>SBL power (Watt)</b> | 100 W     | 100 W      | 200 W      | 250 W      |

\* MRP - Maximum Retail Price Inclusive of all taxes including GST.

**Bold Cat.Nos** are products normally available with Legrand (India) Stockists. **Cat.Nos** that are not bold - delivery within 4 - 8 weeks from the date of order. **Bold packing quantity** is our mandatory packing. Orders to be placed by Legrand (India) Stockist in multiples of the same.

# Myrius™

A Perfect Blend of Design & Convenience



Myrius™ is designed to enhance modern living spaces by combining refined aesthetics with everyday usability. It brings together thoughtful design and intuitive functionality to create a seamless and comfortable user experience.

## Features

- In-Mould decoration (IMD) technology enabling customised smart functions
- Integrated smart functionality for enhanced control and convenience
- Wide range of designer finishes to suit diverse interior styles
- Available in 11 premium plate finish options

## Benefits

- Elevates interiors with distinctive designer aesthetics
- Enables personalised living through customised smart features
- Offers flexibility in design with a wide range of finishes
- Enhances everyday convenience with intuitive functionality

Scan to know more about the product.



# Myrius: The best of both worlds

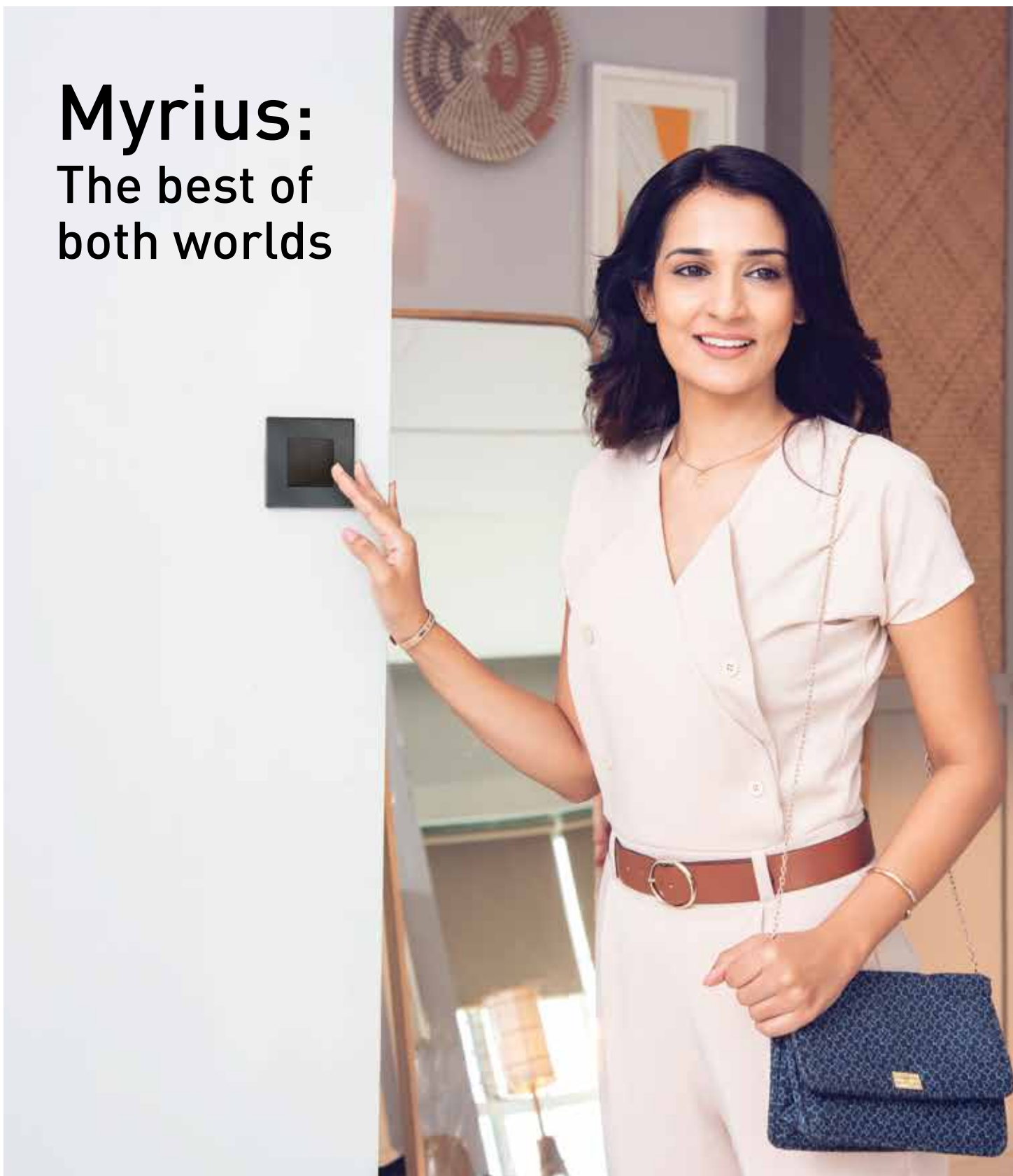

# Myrius™

## Premium Glass Finish for Modern Interiors



MYRIUS GLASS FINISH

Myrius™ Glass plate enhances interior spaces with sleek glass finishes and a refined flush design, bringing a modern and sophisticated aesthetic to premium environments.

### Features

- 3 mm toughened glass finishes available in white and black
- Plate range from 1 to 18 modules for design flexibility
- Available in multiple colour options

### Benefits

- Enhances interior aesthetics with elegant and modern glass finishes
- Adds a modern and sophisticated look to spaces
- Ensures design flexibility across different layouts



# Myrius™

Designed for Hygiene.  
Built for Everyday  
Living.



ANTI-BACTERIAL RANGE

Myrius™ Anti-Bacterial Range is designed to support healthier living by reducing bacterial presence on frequently touched surfaces, combining hygiene with modern design for everyday spaces.

## Features

- Silver ion-infused surfaces for antibacterial protection
- Smooth finish for easy cleaning and maintenance
- Certified antibacterial performance
- Contemporary design suitable for modern interiors

## Benefits

- Reduces bacterial presence on frequently touched surfaces
- Supports a healthier home environment
- Enhances everyday safety through hygienic materials
- Combines hygiene with modern aesthetics



## Myrius™

### Cover Plates Cover Plates

| Cat.Nos | Description | MRP*<br>₹ / Unit | Pack |
|---------|-------------|------------------|------|
|---------|-------------|------------------|------|

#### Switches 6A - 230V AC

|         |   |     |          |
|---------|---|-----|----------|
| 6792 00 | 6A - Switch - 1 Way - 1 Module                        | 160 | 1/20/200 |
| 6792 01 | 6A - Switch - 2 Way - 1 Module                        | 292 | 1/20/200 |
| 6792 02 | 6A - Switch - 1 Way - with Indicator - 1 Module       | 270 | 1/20/200 |
| 6792 03 | 6A - Switch - 1 Way - with "Light" Marking - 1 Module | 230 | 1/20/200 |
| 6792 04 | 6A - Switch - 1 Way - with "Fan" Marking - 1 Module   | 230 | 1/20/200 |

#### Switches - 10A - 230V AC

|         |  |      |          |
|---------|--|------|----------|
| 6793 00 | 10A - Switch - 1 Way - 1 Module                  | 170  | 20/200   |
| 6793 01 | 10A - Switch - 2 Way - 2 Module                  | 298  | 20/200   |
| 6793 02 | 10A - Switch - 1 Way - with Indicator - 1 Module | 278  | 20/200   |
| 6792 05 | 10A - Switch - 1 Way - 2 Module                  | 344  | 1/10/100 |
| 6792 06 | 10A - Switch - 2 Way - 2 Module                  | 408  | 1/10/100 |
| 6792 07 | 10A - Intermediate Switch - 230V AC - 2 Module   | 2220 | 1/10/100 |
| 6792 08 | 10A - Switch - 1 Way - with Indicator - 2 Module | 426  | 1/10/100 |

#### Switches - 16A - 230V AC

|         |  |     |          |
|---------|--|-----|----------|
| 6792 09 | 16A - Switch - 1 Way - 1 Module                  | 388 | 1/20/200 |
| 6792 10 | 16A - Switch - 2 Way - 1 Module                  | 440 | 1/20/200 |
| 6792 11 | 16A - Switch - 1 Way - with Indicator - 1 Module | 468 | 1/20/200 |

#### Switches - 20A - 230V AC

|         |   |     |          |
|---------|---|-----|----------|
| 6792 12 | 20A - Switch - 1 Way - 1 Module                       | 512 | 1/20/200 |
| 6792 13 | 20A - Switch - DP - 1 Way - 2 Module                  | 784 | 1/10/100 |
| 6792 14 | 20A - Switch - DP - 1 Way - with Indicator - 2 Module | 838 | 1/10/100 |
| 6792 15 | 20A - Switch - 2 Way - 2 Module                       | 864 | 1/10/100 |

#### Switches - 25A - 230V AC

|         |   |     |          |
|---------|---|-----|----------|
| 6792 16 | 25A - Switch - SP - 1 Way - with Indicator - 1 Module | 576 | 1/20/200 |
|---------|---|-----|----------|

#### Switches - 32A - 230V AC

|         |   |      |          |
|---------|---|------|----------|
| 6792 17 | 32A - Switch - DP - with Indicator - 2 Module | 1284 | 1/10/100 |
|---------|---|------|----------|

## Myrius™

### Classic White Mechanism

| Cat.Nos | Description | MRP*<br>₹ / Unit | Pack |
|---------|-------------|------------------|------|
|---------|-------------|------------------|------|

#### Push Button - 6A - 230V AC

|         |   |     |          |
|---------|---|-----|----------|
| 6792 18 | 6A - Push Button - SP - 1 Module                          | 324 | 1/20/200 |
| 6792 19 | 6A - Push Button - SP - 1 Way - with Indicator - 1 Module | 426 | 1/20/200 |
| 6792 20 | 6A - Bell Push - 1 Way - 1 Module                         | 326 | 1/20/200 |
| 6792 21 | 6A - Bell Push - 1 Way - with Indicator - 1 Module        | 426 | 1/20/200 |
| 6792 22 | 6A - Bell Push - 1 Way - 2 Module                         | 494 | 1/10/100 |
| 6792 23 | 6A - Bell Push - 1 Way - with Indicator - 2 Module        | 576 | 1/10/100 |

#### Accessories for Switches

|         |                             |    |        |
|---------|-----------------------------|----|--------|
| 6792 24 | Lamp for Switches - 230V AC | 80 | 1/5/50 |
|---------|-----------------------------|----|--------|

#### Indian Standard Socket

|         |   |      |          |
|---------|---|------|----------|
| 6792 35 | 6A - Socket - with Shutter - 3 Pin - ISI - 2 Module   | 278  | 1/20/200 |
| 6792 30 | 6/16A - Socket - with Shutter - ISI - 2 Module        | 592  | 1/10/100 |
| 6792 29 | 6/16A - Socket - with Shutter - ISI - 3 Module        | 708  | 1/5/50   |
| 6792 26 | 16A - Switch Socket - with Shutter - 3 Pin - 3 Module | 1538 | 1/5/50   |

#### Dimmers & Fan Regulators

|         |   |      |          |
|---------|---|------|----------|
| 6792 36 | Rotary Dimmer - 400 Watts - 1 Module              | 1504 | 5/50     |
| 6792 37 | Rotary Light Dimmer - 500 Watts - 2 Module        | 2270 | 10/100   |
| 6792 39 | Fan Regulator - 100 Watts - ISI - 1 Module        | 1168 | 5/50     |
| 6792 40 | Fan Regulator - 100 Watts - 360° - ISI - 2 Module | 1340 | 10/100   |
| 6792 41 | Fan Regulator - 120 Watts - 360° - ISI - 2 Module | 1446 | 10/100   |
| 6792 42 | Fan Regulator - 70 Watts - ISI - 2 Module         | 1402 | 1/10/100 |
| 6792 31 | Fan Regulator - 8 Step - 100 Watts ISI - 2 Module | 1224 | 10/100   |
| 6792 96 | Fan Regulator - BLDC - 2 Module <sup>^</sup>      | 1426 | 10/100   |

\* MRP - Maximum Retail Price Inclusive of all taxes including GST.

<sup>^</sup> Compatible with Atomberg (Efficio), Havells (Eficiencia neo), Orient (Aerostorm) as per 2023 fan models.

Bold Cat.Nos are products normally available with Legrand (India) Stockists. Cat.Nos that are not bold - delivery within 4 - 8 weeks from the date of order. Bold packing quantity is our mandatory packing. Orders to be placed by Legrand (India) Stockist in multiples of the same.

## Myrius™

### Classic White Mechanism

| Cat.Nos | Description | MRP<br>₹ /<br>Unit | Pack |
|---------|-------------|--------------------|------|
|---------|-------------|--------------------|------|

#### Emergency Light

|         |   |      |          |
|---------|---|------|----------|
| 6792 43 | Emergency Removable LED Lamp - 2 Module | 3742 | 1/10/100 |
|---------|---|------|----------|

#### Skirting Light

|         |   |      |        |
|---------|---|------|--------|
| 6792 48 | Skirting Light - with Warm White LED - 3 Module | 1132 | 1/5/25 |
|---------|---|------|--------|

#### Indicator

|                     |  |     |          |
|---------------------|--|-----|----------|
| <b>NEW!</b> 6792 97 | Indicator Unit - with Transparent LED - 1 Module | 626 | 1/10/100 |
|---------------------|--|-----|----------|

#### Bell Call Indicator

|         |                                |      |          |
|---------|--------------------------------|------|----------|
| 6792 49 | Bell Call Indicator - 1 Module | 1492 | 1/20/200 |
|---------|--------------------------------|------|----------|

#### Buzzer

|         |                          |      |          |
|---------|--------------------------|------|----------|
| 6792 50 | Buzzer - 230V - 1 Module | 1378 | 1/20/200 |
|---------|--------------------------|------|----------|

#### Infrared Sensors

|         |   |      |      |
|---------|---|------|------|
| 6792 51 | Infrared Sensor Switch - 400 Watts - 2 Module | 2632 | 1/50 |
|---------|---|------|------|

#### Remote Unit

|         |  |      |        |
|---------|--|------|--------|
| 6792 52 | Remote Control Unit - for Light & Fan - 4 Module | 8988 | 1/5/20 |
| 6793 03 | Remote Control Hand Unit                         | 794  | 1/5/30 |

#### Hospitality Function

##### Hotel Keycard Switch

|         |                                  |      |          |
|---------|----------------------------------|------|----------|
| 6792 53 | 16A - Key Card Switch - 2 Module | 5390 | 1/10     |
| 6792 55 | Key Fob for Key Card Switch      | 234  | 1/10/100 |

##### Hotel "DND and MMR" Functions

|         |   |      |          |
|---------|---|------|----------|
| 6792 56 | External DND & MMR Control Unit - with Bell Push - 2 Module | 2298 | 1/10/100 |
| 6792 57 | Internal DND & MMR Control Unit - 2 Module                  | 1534 | 1/10/100 |

#### Shaver Socket

|         |   |      |        |
|---------|---|------|--------|
| 6792 58 | Shaver Socket - 110/230V AC - Monoblock with Plate - 2 Module | 4012 | 1/16   |
| 6792 59 | Shaver Socket - 110/230V AC - Monoblock with Plate - 4 Module | 6552 | 1/5/20 |

#### Tv Sockets

|         |                                 |     |          |
|---------|---------------------------------|-----|----------|
| 6792 60 | TV Co - axial Socket - 1 Module | 302 | 1/20/200 |
|---------|---------------------------------|-----|----------|

#### Data & Voice

|         |   |      |          |
|---------|---|------|----------|
| 6792 62 | Telephone Socket - RJ11 - 1 Module  | 298  | 1/20/200 |
| 6792 63 | Telephone Socket - Double RJ11 - 1 Module                                   | 460  | 1/20/200 |
| 6792 64 | Information Socket - RJ45 - Cat 5E - UTP - Toolless with Shutter - 1 Module | 609  | 1/20/200 |
| 6792 65 | Information Socket - RJ45 - Cat 6 - UTP - Toolless with Shutter - 1 Module  | 907  | 1/20/200 |
| 6792 66 | Information Socket - RJ45 - Cat 6 - UTP - Toolless with Shutter - 2 Module  | 925  | 1/10/100 |
| 6797 13 | Information Socket - RJ45 - Cat 6A - STP - 1 Module                         | 1065 | 20/200   |

## Myrius™

### Classic White Mechanism

| Cat.Nos | Description | MRP<br>₹ /<br>Unit | Pack |
|---------|-------------|--------------------|------|
|---------|-------------|--------------------|------|

#### Audio Video Connectors

|         |  |      |      |
|---------|--|------|------|
| 6792 67 | Preterminated Audio/Video Connector - 1 Module | 2399 | 1/10 |
| 6792 68 | Preterminated Projector Connector - 1 Module   | 2939 | 1/10 |
| 6792 69 | Preterminated HDMI Socket - 1 Module           | 2939 | 1/10 |

#### Sound (Volume Controller)

|         |                              |      |          |
|---------|------------------------------|------|----------|
| 6792 70 | Volume Controller - 2 Module | 1795 | 1/10/100 |
|---------|------------------------------|------|----------|

#### Protectors & Accessories

##### Motor Starter

|         |                                |     |          |
|---------|--------------------------------|-----|----------|
| 6792 71 | 16A - Motor Starter - 2 Module | 952 | 1/10/100 |
| 6792 72 | 25A - Motor Starter - 2 Module | 972 | 1/10/100 |

#### Electronic Function

##### USB Chargers (IS13252(Part 1) / IEC 60950-1)

|                     |   |       |          |
|---------------------|---|-------|----------|
| 6792 88             | USB Charger - 1500mA - Type A - 1 Module                        | 2056  | 1/5/50   |
| 6792 89             | USB Charger - 3000mA - Type A + C - 2 Module                    | 3180  | 1/10/100 |
| 6797 51             | USB Charger - 3000mA/15 Watts - Type A - 1 Module               | 2376  | 1/5/50   |
| 6797 52             | USB Charger - 3000mA/15 Watts - Type A + A - 1 Module           | 2676  | 1/5/50   |
| 6797 53             | USB Charger - 3000mA/15 Watts - Type A + C - 1 Module           | 3408  | 1/5/50   |
| 6797 54             | USB Charger - 3000mA/15 Watts - Type C + C - 1 Module           | 3722  | 1/5/50   |
| 6797 55             | USB Charger - Power Delivery - 20 Watts - Type C - 1 Module     | 4534  | 1/5/50   |
| 6792 73             | USB Charger - Power Delivery - 30 Watts - Type C + C - 2 Module | 6878  | 1/3/30   |
| 6797 57             | USB Charger - Power Delivery - 45 Watts - Type C - 2 Module     | 8966  | 1/3/30   |
| <b>NEW!</b> 6797 59 | USB Charger - Power Delivery - 65 Watts - Type C + C - 3 Module | 11058 | 1/5/20   |

#### Loud Speakers

|         |                                     |      |     |
|---------|-------------------------------------|------|-----|
| 6792 98 | Ceiling Loudspeaker - 8Ohms - 100mm | 3759 | 1/6 |
|---------|-------------------------------------|------|-----|

#### Sound Diffusion

|         |                                      |      |          |
|---------|--------------------------------------|------|----------|
| 6792 99 | Bluetooth Sound Diffusion - 2 Module | 7697 | 1/10/100 |
|---------|--------------------------------------|------|----------|

#### Rotary Dimmer Universal

|         |   |      |          |
|---------|---|------|----------|
| 6793 04 | Rotary LED Light Dimmer - 50 Watts - 1 Module | 3110 | 1/10/120 |
|---------|---|------|----------|

\* MRP - Maximum Retail Price Inclusive of all taxes including GST.  
Red Cat. Nos - New Products

Bold Cat.Nos are products normally available with Legrand (India) Stockists. Cat.Nos that are not bold - delivery within 4 - 8 weeks from the date of order. Bold packing quantity is our mandatory packing. Orders to be placed by Legrand (India) Stockist in multiples of the same.

## Myrius™

### Classic White Mechanism

| Cat.Nos | Description | MRP*<br>₹ / Unit | Pack |
|---------|-------------|------------------|------|
|---------|-------------|------------------|------|

#### Touch Switches

|         |  |      |      |
|---------|--|------|------|
| 6793 08 | Touch Switch - 2 Switch - 1 Way - 1000 Watts - 2 Module - Silver | 4350 | 1/50 |
| 6793 09 | Touch Switch - 1 Way - 1440 Watts - 2 Module - Silver            | 4350 | 1/50 |
| 6793 10 | Touch Switch - 2 Way - 1000 Watts - 2 Module - Silver            | 5030 | 1/50 |
| 6793 13 | Touch Switch - 1 Way - 3000 Watts - 2 Module - Silver            | 5030 | 1/50 |
| 6793 06 | Touch Switch - Bell Push - 1440 Watts - 2 Module - Silver        | 4350 | 1/50 |

#### Touch Regulator, Curtain & Dimmer

|         |   |      |      |
|---------|---|------|------|
| 6793 07 | Touch Switch - Curtain Controller - 2 Module - Silver             | 5030 | 1/50 |
| 6793 05 | Touch Fan Regulator - 100 Watts - 2 Module - Silver               | 5030 | 1/50 |
| 6793 15 | Universal LED Touch Scroll Dimmer - 300 Watts - 2 Module - Silver | 4976 | 1/50 |

#### Reading Light

|         |                              |      |      |
|---------|------------------------------|------|------|
| 6793 16 | Reading Light LED - 2 Module | 3110 | 1/10 |
|---------|------------------------------|------|------|

#### Accessories

|         |                               |     |          |
|---------|-------------------------------|-----|----------|
| 6792 75 | Cable Outlet - 8mm - 1 Module | 336 | 1/20/200 |
| 6792 76 | Blanking Plate - 1 Module     | 62  | 1/40/400 |
| 6792 77 | Blanking Plate - 2 Module     | 72  | 1/10/100 |

### Charcoal Grey- Mechanism

#### Switches - 6A - 230V AC

|         |   |     |          |
|---------|---|-----|----------|
| 6794 00 | 6A - Switch - 1 Way - 1 Module                        | 198 | 1/20/200 |
| 6794 01 | 6A - Switch - 2 Way - 1 Module                        | 324 | 1/20/200 |
| 6794 02 | 6A - Switch - 1 Way - with Indicator - 1 Module       | 352 | 1/20/200 |
| 6794 03 | 6A - Switch - 1 Way - with "Light" Marking - 1 Module | 274 | 1/20/200 |
| 6794 04 | 6A - Switch - 1 Way - with "Fan" Marking - 1 Module   | 274 | 1/20/200 |

#### Switches - 10A - 230V AC

|         |  |      |          |
|---------|--|------|----------|
| 6794 05 | 10A - Switch - 1 Way - 2 Module                  | 412  | 1/10/100 |
| 6794 06 | 10A - Switch - 2 Way - 2 Module                  | 440  | 1/10/100 |
| 6794 07 | 10A - Intermediate Switch - 230V AC - 2 Module   | 2558 | 1/10/100 |
| 6794 08 | 10A - Switch - 1 Way - with Indicator - 2 Module | 474  | 1/10/100 |

## Myrius™

### Charcoal Grey Mechanism

| Cat.Nos | Description | MRP*<br>₹ / Unit | Pack |
|---------|-------------|------------------|------|
|---------|-------------|------------------|------|

#### Switches - 16A - 230V AC

|         |  |     |          |
|---------|--|-----|----------|
| 6794 09 | 16A - Switch - 1 Way - 1 Module                  | 432 | 1/20/200 |
| 6794 10 | 16A - Switch - 2 Way - 1 Module                  | 526 | 1/20/200 |
| 6794 11 | 16A - Switch - 1 Way - with Indicator - 1 Module | 544 | 1/20/200 |

#### Switches - 20A - 230V AC

|         |   |     |          |
|---------|---|-----|----------|
| 6794 12 | 20A - Switch - 1 Way - 1 Module                       | 582 | 1/20/200 |
| 6794 13 | 20A - Switch - DP - 1 Way - 2 Module                  | 908 | 1/10/100 |
| 6794 14 | 20A - Switch - DP - 1 Way - with Indicator - 2 Module | 964 | 1/10/100 |
| 6794 15 | 20A - Switch - 2 Way - 2 Module                       | 992 | 1/10/100 |

#### Switches - 25A - 230V AC

|         |   |     |          |
|---------|---|-----|----------|
| 6794 16 | 25A - Switch - SP - 1 Way - with Indicator - 1 Module | 664 | 1/20/200 |
|---------|---|-----|----------|

#### Switches 32A 230V AC

|         |   |      |          |
|---------|---|------|----------|
| 6794 17 | 32A - Switch - DP - with Indicator - 2 Module | 1480 | 1/10/100 |
|---------|---|------|----------|

#### Push Button 6A 230V AC

|         |  |     |          |
|---------|--|-----|----------|
| 6794 18 | 6A - Push Button - SP - 1 Way - 1 Module             | 386 | 1/20/200 |
| 6794 19 | 6A - Push Button - 1 Way - with Indicator - 1 Module | 482 | 1/20/200 |
| 6794 20 | 6A - Bell Push - 1 Way - 1 Module                    | 360 | 1/20/200 |
| 6794 21 | 6A - Bell Push - 1 Way - with Indicator - 1 Module   | 482 | 1/20/200 |
| 6794 22 | 6A - Bell Push - 1 Way - 2 Module                    | 556 | 1/10/100 |
| 6794 23 | 6A - Bell Push - 1 Way - with Indicator - 2 Module   | 664 | 1/10/100 |

#### Indian Standard Socket

|         |   |      |          |
|---------|---|------|----------|
| 6794 35 | 6A - Socket - with Shutter - 3 Pin - ISI - 2 Module     | 318  | 1/20/200 |
| 6794 30 | 6/16A - Socket - with Shutter - ISI - 2 Module          | 696  | 1/10/100 |
| 6794 29 | 6/16A - Socket - with Shutter - ISI - 3 Module          | 822  | 1/5/50   |
| 6794 26 | 16A - Switched Socket - with Shutter - 3 Pin - 3 Module | 1752 | 1/5/50   |

\* MRP - Maximum Retail Price Inclusive of all taxes including GST.

Bold Cat.Nos are products normally available with Legrand (India) Stockists. Cat.Nos that are not bold - delivery within 4 - 8 weeks from the date of order. Bold packing quantity is our mandatory packing. Orders to be placed by Legrand (India) Stockist in multiples of the same.

## Myrius™ Charcoal Grey Mechanism

| Cat.Nos | Description | MRP<br>₹ /<br>Unit | Pack |
|---------|-------------|--------------------|------|
|---------|-------------|--------------------|------|

### Dimmers & Fan Regulators

|         |  |      |          |
|---------|--|------|----------|
| 6794 36 | Rotary Dimmer - 400 Watts - 1 Module                 | 1720 | 5/50     |
| 6794 37 | Rotary Light Dimmer - 500 Watts - 2 Module           | 2612 | 10/100   |
| 6794 39 | Fan Regulator - 100 Watts - ISI - 1 Module           | 1344 | 5/50     |
| 6794 40 | Fan Regulator - 100 Watts - 360° - ISI - 2 Module    | 1522 | 10/100   |
| 6794 41 | Fan Regulator - 120 Watts - 360° - ISI - 2 Module    | 1678 | 10/100   |
| 6794 42 | Fan Regulator - 70 Watts - ISI - 2 Module            | 1620 | 1/10/100 |
| 6794 31 | Fan Regulator - 8 Steps - 100 Watts - ISI - 2 Module | 1392 | 10/100   |
| 6794 96 | Fan Regulator - BLDC - 2 Module <sup>A</sup>         | 1646 | 10/100   |

### Skirting Light

|         |   |      |        |
|---------|---|------|--------|
| 6794 48 | Skirting Light - with Warm White LED - 3 Module | 1296 | 1/5/25 |
|---------|---|------|--------|

### Bell Call Indicator

|         |                                |      |          |
|---------|--------------------------------|------|----------|
| 6794 49 | Bell Call Indicator - 1 Module | 1736 | 1/20/200 |
|---------|--------------------------------|------|----------|

### Buzzer

|         |                          |      |          |
|---------|--------------------------|------|----------|
| 6794 50 | Buzzer - 230V - 1 Module | 1582 | 1/20/200 |
|---------|--------------------------|------|----------|

### Remote Unit

|         |  |       |        |
|---------|--|-------|--------|
| 6794 52 | Remote Control Unit - for Light & Fan - 4 Module | 10332 | 1/5/20 |
| 6793 03 | Remote Control Hand Unit                         | 794   | 1/5/30 |

### Hospitality Function Hotel Keycard Switch

|         |                                  |      |          |
|---------|----------------------------------|------|----------|
| 6794 53 | 16A - Key Card Switch - 2 Module | 6200 | 1/10     |
| 6792 55 | Key Fob for Key Card Switch      | 234  | 1/10/100 |

### Hotel "DND and MMR" Functions

|         |   |      |          |
|---------|---|------|----------|
| 6794 54 | External DND & MMR Control Unit - with Bell Push - 2 Module | 2636 | 1/10/100 |
| 6794 55 | Internal DND & MMR Control Unit - 2 Module                  | 1738 | 1/10/100 |

### Shaver Socket

|         |   |      |        |
|---------|---|------|--------|
| 6794 58 | Shaver Socket - 120/240V AC - Monoblock with Plate - 2 Module | 4568 | 1/16   |
| 6794 59 | Shaver Socket - 120/230V AC - Monoblock with Plate - 4 Module | 7248 | 1/5/20 |

### Sockets & Connectors

#### Tv Sockets

|         |                                 |     |          |
|---------|---------------------------------|-----|----------|
| 6794 60 | TV Co - axial Socket - 1 Module | 362 | 1/20/200 |
|---------|---------------------------------|-----|----------|

## Myrius™ Charcoal Grey Mechanism

| Cat.Nos | Description | MRP<br>₹ /<br>Unit | Pack |
|---------|-------------|--------------------|------|
|---------|-------------|--------------------|------|

### Data & Voice

|         |   |      |          |
|---------|---|------|----------|
| 6794 62 | Telephone Socket - RJ11 - 1 Module  | 348  | 1/20/200 |
| 6794 63 | Telephone Socket - Double RJ11 - 1 Module                                   | 534  | 1/20/200 |
| 6794 64 | Information Socket - RJ45 - Cat 5E - UTP - Toolless with Shutter - 1 Module | 706  | 1/20/200 |
| 6794 65 | Information Socket - RJ45 - Cat 6 - UTP - Toolless with Shutter - 1 Module  | 1042 | 1/20/200 |
| 6794 66 | Information Socket - RJ45 - Cat 6 - UTP - Toolless with Shutter - 2 Module  | 1069 | 1/10/100 |
| 6797 14 | Information Socket - RJ45 - Cat 6A - STP - 1 Module                         | 1214 | 20/200   |

### Audio & Video Connectors

|         |  |      |      |
|---------|--|------|------|
| 6794 67 | Preterminated Audio/Video Connector - 1 Module | 2756 | 1/10 |
| 6794 68 | Preterminated HDMI Socket - 1 Module           | 3376 | 1/10 |
| 6794 69 | Preterminated Projector Connector - 1 Module   | 3376 | 1/10 |

### Sound (Volume Controller)

|         |                              |      |          |
|---------|------------------------------|------|----------|
| 6794 70 | Volume Controller - 2 Module | 2083 | 1/10/100 |
|---------|------------------------------|------|----------|

### Protectors & Accessories Motor Starter

|         |                                |      |          |
|---------|--------------------------------|------|----------|
| 6794 71 | 16A - Motor Starter - 2 Module | 1098 | 1/10/100 |
| 6794 72 | 25A - Motor Starter - 2 Module | 1122 | 1/10/100 |

### Electronic Function

#### USB Chargers (IS13252 (Part 1) / IEC 60950-1)

|                |   |       |          |
|----------------|---|-------|----------|
| 6794 88        | USB Charger - 1500mA - Type A - 1 Module                        | 2358  | 1/5/100  |
| 6794 89        | USB Charger - 3000mA - Type A + C - 2 Module                    | 3654  | 1/10/100 |
| 6798 51        | USB Charger - 3000mA/15 Watts - Type A - 1 Module               | 2720  | 1/5/50   |
| 6798 52        | USB Charger - 3000mA/15 Watts - Type A + A - 1 Module           | 3002  | 1/5/50   |
| 6798 53        | USB Charger - 3000mA/15 Watts - Type A + C - 1 Module           | 3826  | 1/5/50   |
| 6798 54        | USB Charger - 3000mA/15 Watts - Type C + C - 1 Module           | 4054  | 1/5/50   |
| 6798 55        | USB Charger - Power Delivery - 20 Watts - Type C - 1 Module     | 5002  | 1/5/50   |
| 6792 74        | USB Charger - Power Delivery - 30 Watts - Type C + C - 2 Module | 7272  | 1/3/30   |
| 6798 57        | USB Charger - Power Delivery - 45 Watts - Type C - 2 Module     | 9442  | 1/3/30   |
| <b>6798 59</b> | USB Charger - Power Delivery - 65 Watts - Type C + C - 3 Module | 11614 | 1/5/20   |

\* MRP - Maximum Retail Price Inclusive of all taxes including GST.

<sup>A</sup> Compatible with Atomberg (Efficio), Havells (Efficiencia neo), Orient (Aerostorm) as per 2023 fan models.

Red Cat. Nos - New Products

Bold Cat.Nos are products normally available with Legrand (India) Stockists. Cat.Nos that are not bold - delivery within 4 - 8 weeks from the date of order. Bold packing quantity is our mandatory packing. Orders to be placed by Legrand (India) Stockist in multiples of the same.

## Myrius™

### Classic White Anti Bacterial Mechanism

| Cat.Nos | Description | MRP<br>₹ /<br>Unit | Pack |
|---------|-------------|--------------------|------|
|---------|-------------|--------------------|------|

#### Sound Receiver

|         |                                      |      |          |
|---------|--------------------------------------|------|----------|
| 6794 97 | Bluetooth Sound Diffusion - 2 Module | 8854 | 1/10/100 |
|---------|--------------------------------------|------|----------|

#### Rotary Dimmer Universal

|         |   |      |          |
|---------|---|------|----------|
| 6794 98 | Rotary LED Light Dimmer - 50 Watts - 1 Module | 3544 | 1/10/120 |
|---------|---|------|----------|

#### Accessories

|         |                               |     |          |
|---------|-------------------------------|-----|----------|
| 6794 75 | Cable Outlet - 8mm - 1 Module | 392 | 1/20/200 |
|---------|-------------------------------|-----|----------|

|         |                           |    |          |
|---------|---------------------------|----|----------|
| 6794 76 | Blanking Plate - 1 Module | 68 | 1/40/400 |
|---------|---------------------------|----|----------|

#### Classic White - Anti Bacterial Mechanism Switches - 6A - 230V AC

|         |   |     |          |
|---------|---|-----|----------|
| 6793 20 | 6A - Switch - 1 Way - 1 Module - Anti - Bacterial | 232 | 1/20/200 |
|---------|---|-----|----------|

|         |   |     |          |
|---------|---|-----|----------|
| 6793 21 | 6A - Switch - 2 Way - 1 Module - Anti - Bacterial | 342 | 1/20/200 |
|---------|---|-----|----------|

|         |  |     |          |
|---------|--|-----|----------|
| 6793 24 | 6A - Bell Push - 1 Module - Anti - Bacterial | 398 | 1/20/200 |
|---------|--|-----|----------|

#### Switches - 16A - 230V AC

|         |  |     |          |
|---------|--|-----|----------|
| 6793 22 | 16A - Switch - 1 Way - 1 Module - Anti - Bacterial | 468 | 1/20/200 |
|---------|--|-----|----------|

|         |  |     |          |
|---------|--|-----|----------|
| 6793 23 | 16A - Switch - 2 Way - 1 Module - Anti - Bacterial | 544 | 1/20/200 |
|---------|--|-----|----------|

#### Indian Standard Socket

|         |  |     |          |
|---------|--|-----|----------|
| 6792 38 | 6A - Socket - with Shutter - 3 Pin - ISI - 2 Module - Anti - Bacterial | 348 | 1/20/200 |
|---------|--|-----|----------|

|         |   |     |          |
|---------|---|-----|----------|
| 6793 28 | 6/16A - Socket - with Shutter - ISI - 2 Module - Anti - Bacterial | 812 | 1/10/100 |
|---------|---|-----|----------|

|         |   |     |        |
|---------|---|-----|--------|
| 6793 29 | 6/16A - Socket - with Shutter - ISI - 3 Module - Anti - Bacterial | 874 | 1/5/50 |
|---------|---|-----|--------|

#### Fan Regulators

|         |  |      |        |
|---------|--|------|--------|
| 6793 25 | Fan Regulator - 120 Watts - 360° - ISI - 2 Module - Anti - Bacterial | 1776 | 10/100 |
|---------|--|------|--------|

#### TV Sockets

|         |  |     |          |
|---------|--|-----|----------|
| 6793 30 | TV Co - axial Socket - 1 Module - Anti - Bacterial | 362 | 1/20/200 |
|---------|--|-----|----------|

#### Data & Voice

|         |   |     |          |
|---------|---|-----|----------|
| 6793 31 | Telephone Socket - RJ11 - 1 Module - Anti - Bacterial | 362 | 1/20/200 |
|---------|---|-----|----------|

|         |   |      |          |
|---------|---|------|----------|
| 6793 32 | Information Socket - RJ45 - Cat 6 - UTP - 1 Module - Anti - Bacterial | 1104 | 1/20/200 |
|---------|---|------|----------|

#### Accessories

|         |  |    |          |
|---------|--|----|----------|
| 6793 33 | Blanking Plate - 1 Module - Anti - Bacterial | 62 | 1/40/400 |
|---------|--|----|----------|

## Myrius™

### Cover Plates

| Cat.Nos | Description | MRP<br>₹ /<br>Unit | Pack |
|---------|-------------|--------------------|------|
|---------|-------------|--------------------|------|

#### Cover Plates with Support Frame

##### Classic White Cover Plates with Support Frame

|         |  |     |        |
|---------|--|-----|--------|
| 6795 01 | Cover Plate - 1 Module - Classic White | 248 | 20/200 |
|---------|--|-----|--------|

|         |  |     |        |
|---------|--|-----|--------|
| 6795 02 | Cover Plate - 2 Module - Classic White | 258 | 20/200 |
|---------|--|-----|--------|

|         |  |     |        |
|---------|--|-----|--------|
| 6795 03 | Cover Plate - 3 Module - Classic White | 272 | 10/100 |
|---------|--|-----|--------|

|         |  |     |        |
|---------|--|-----|--------|
| 6795 04 | Cover Plate - 4 Module - Classic White | 304 | 10/100 |
|---------|--|-----|--------|

|         |  |     |      |
|---------|--|-----|------|
| 6795 06 | Cover Plate - 6 Module - Classic White | 526 | 5/50 |
|---------|--|-----|------|

|         |  |     |      |
|---------|--|-----|------|
| 6795 08 | Cover Plate - 8 Module - Classic White | 576 | 5/50 |
|---------|--|-----|------|

|         |  |     |      |
|---------|--|-----|------|
| 6795 09 | Cover Plate - 2*4 Module - Classic White | 732 | 5/25 |
|---------|--|-----|------|

|         |  |     |      |
|---------|--|-----|------|
| 6795 10 | Cover Plate - 9 Module - Classic White | 774 | 5/50 |
|---------|--|-----|------|

|         |   |     |      |
|---------|---|-----|------|
| 6795 12 | Cover Plate - 12 Module - Classic White | 878 | 1/10 |
|---------|---|-----|------|

|         |   |      |      |
|---------|---|------|------|
| 6795 16 | Cover Plate - 16 Module - Classic White | 1022 | 1/10 |
|---------|---|------|------|

|         |  |      |      |
|---------|--|------|------|
| 6795 17 | Cover Plate - 16 Module(Big) - Classic White | 1108 | 1/10 |
|---------|--|------|------|

|         |   |      |      |
|---------|---|------|------|
| 6795 18 | Cover Plate - 18 Module - Classic White | 1172 | 1/10 |
|---------|---|------|------|

##### Charcoal Grey Cover Plates with Support Frame

|         |  |     |        |
|---------|--|-----|--------|
| 6797 01 | Cover Plate - 1 Module - Charcoal Grey | 300 | 20/200 |
|---------|--|-----|--------|

|         |  |     |        |
|---------|--|-----|--------|
| 6797 02 | Cover Plate - 2 Module - Charcoal Grey | 314 | 20/200 |
|---------|--|-----|--------|

|         |  |     |        |
|---------|--|-----|--------|
| 6797 03 | Cover Plate - 3 Module - Charcoal Grey | 340 | 10/100 |
|---------|--|-----|--------|

|         |  |     |        |
|---------|--|-----|--------|
| 6797 04 | Cover Plate - 4 Module - Charcoal Grey | 364 | 10/100 |
|---------|--|-----|--------|

|         |  |     |      |
|---------|--|-----|------|
| 6797 06 | Cover Plate - 6 Module - Charcoal Grey | 650 | 5/50 |
|---------|--|-----|------|

|         |  |     |      |
|---------|--|-----|------|
| 6797 08 | Cover Plate - 8 Module - Charcoal Grey | 708 | 5/50 |
|---------|--|-----|------|

|         |  |     |      |
|---------|--|-----|------|
| 6797 09 | Cover Plate - 2*4 Module - Charcoal Grey | 900 | 5/25 |
|---------|--|-----|------|

|         |  |     |      |
|---------|--|-----|------|
| 6797 10 | Cover Plate - 9 Module - Charcoal Grey | 966 | 5/50 |
|---------|--|-----|------|

|         |   |      |      |
|---------|---|------|------|
| 6797 12 | Cover Plate - 12 Module - Charcoal Grey | 1082 | 1/10 |
|---------|---|------|------|

|         |   |      |      |
|---------|---|------|------|
| 6797 16 | Cover Plate - 16 Module - Charcoal Grey | 1252 | 1/10 |
|---------|---|------|------|

|         |  |      |      |
|---------|--|------|------|
| 6797 17 | Cover Plate - 16 Module(Big) - Charcoal Grey | 1348 | 1/10 |
|---------|--|------|------|

|         |   |      |      |
|---------|---|------|------|
| 6797 18 | Cover Plate - 18 Module - Charcoal Grey | 1440 | 1/10 |
|---------|---|------|------|

##### Ice White Cover Plates with Support Frame

|         |                                    |     |        |
|---------|------------------------------------|-----|--------|
| 6795 21 | Cover Plate - 1 Module - Ice White | 352 | 1/5/30 |
|---------|------------------------------------|-----|--------|

|         |                                    |     |        |
|---------|------------------------------------|-----|--------|
| 6795 22 | Cover Plate - 2 Module - Ice White | 372 | 1/5/30 |
|---------|------------------------------------|-----|--------|

|         |                                    |     |      |
|---------|------------------------------------|-----|------|
| 6795 23 | Cover Plate - 3 Module - Ice White | 396 | 1/20 |
|---------|------------------------------------|-----|------|

|         |                                    |     |      |
|---------|------------------------------------|-----|------|
| 6795 24 | Cover Plate - 4 Module - Ice White | 422 | 1/20 |
|---------|------------------------------------|-----|------|

|         |                                    |     |      |
|---------|------------------------------------|-----|------|
| 6795 26 | Cover Plate - 6 Module - Ice White | 766 | 1/10 |
|---------|------------------------------------|-----|------|

|         |                                    |     |      |
|---------|------------------------------------|-----|------|
| 6795 28 | Cover Plate - 8 Module - Ice White | 834 | 1/10 |
|---------|------------------------------------|-----|------|

|         |                                      |      |     |
|---------|--------------------------------------|------|-----|
| 6795 29 | Cover Plate - 2*4 Module - Ice White | 1044 | 1/5 |
|---------|--------------------------------------|------|-----|

\* MRP - Maximum Retail Price Inclusive of all taxes including GST.

Bold Cat.Nos are products normally available with Legrand (India) Stockists. Cat.Nos that are not bold - delivery within 4 - 8 weeks from the date of order. Bold packing quantity is our mandatory packing. Orders to be placed by Legrand (India) Stockist in multiples of the same.

## Myrius™

### Cover Plates

| Cat.Nos | Description                              | MRP<br>₹ /<br>Unit | Pack |
|---------|--|--------------------|------|
| 6795 32 | Cover Plate - 12 Module - Ice White      | 1270               | 1/5  |
| 6795 36 | Cover Plate - 16 Module - Ice White      | 1478               | 1/5  |
| 6795 37 | Cover Plate - 16 Module(Big) - Ice White | 1566               | 1/5  |
| 6795 38 | Cover Plate - 18 Module - Ice White      | 1694               | 1/5  |

#### Ice Black Cover Plates with Support Frame

|         |  |      |        |
|---------|--|------|--------|
| 6795 41 | Cover Plate - 1 Module - Ice Black       | 352  | 1/5/30 |
| 6795 42 | Cover Plate - 2 Module - Ice Black       | 372  | 1/5/30 |
| 6795 43 | Cover Plate - 3 Module - Ice Black       | 396  | 1/20   |
| 6795 44 | Cover Plate - 4 Module - Ice Black       | 422  | 1/20   |
| 6795 46 | Cover Plate - 6 Module - Ice Black       | 766  | 1/10   |
| 6795 48 | Cover Plate - 8 Module - Ice Black       | 834  | 1/10   |
| 6795 49 | Cover Plate - 2*4 Module - Ice Black     | 1044 | 1/5    |
| 6795 52 | Cover Plate - 12 Module - Ice Black      | 1270 | 1/5    |
| 6795 56 | Cover Plate - 16 Module - Ice Black      | 1478 | 1/5    |
| 6795 57 | Cover Plate - 16 Module(Big) - Ice Black | 1566 | 1/5    |
| 6795 58 | Cover Plate - 18 Module - Ice Black      | 1694 | 1/5    |

#### Pearl Champagne Cover Plates with Support Frame

|         |   |      |        |
|---------|---|------|--------|
| 6795 61 | Cover Plate - 1 Module - Pearl Champagne              | 480  | 1/5/30 |
| 6795 62 | Cover Plate - 2 Module - Pearl Champagne              | 508  | 1/5/30 |
| 6795 63 | Cover Plate - 3 Module - Pearl Champagne              | 540  | 1/20   |
| 6795 64 | Cover Plate - 4 Module - Pearl Champagne              | 584  | 1/20   |
| 6795 66 | Cover Plate - 6 Module - Pearl Champagne              | 1044 | 1/10   |
| 6795 68 | Cover Plate - 8 Module - Horizontal - Pearl Champagne | 1140 | 1/10   |
| 6795 69 | Cover Plate - 2*4 Module - Vertical - Pearl Champagne | 1428 | 1/5    |
| 6795 72 | Cover Plate - 12 Module - Pearl Champagne             | 1728 | 1/5    |
| 6795 76 | Cover Plate - 16 Module - Pearl Champagne             | 2010 | 1/5    |
| 6795 77 | Cover Plate - 16 Module(Big) - Pearl Champagne        | 2134 | 1/5    |
| 6795 78 | Cover Plate - 18 Module - Pearl Champagne             | 2314 | 1/5    |

#### Sonic Silver Cover Plates with Support Frame

|         |                                       |     |        |
|---------|---------------------------------------|-----|--------|
| 6795 81 | Cover Plate - 1 Module - Sonic Silver | 480 | 1/5/30 |
| 6795 82 | Cover Plate - 2 Module - Sonic Silver | 508 | 1/5/30 |

## Myrius™

### Cover Plates

| Cat.Nos | Description  | MRP<br>₹ /<br>Unit | Pack |
|---------|--|--------------------|------|
| 6795 83 | Cover Plate - 3 Module - Sonic Silver              | 540                | 1/20 |
| 6795 84 | Cover Plate - 4 Module - Sonic Silver              | 584                | 1/20 |
| 6795 86 | Cover Plate - 6 Module - Sonic Silver              | 1044               | 1/10 |
| 6795 88 | Cover Plate - 8 Module - Horizontal - Sonic Silver | 1140               | 1/10 |
| 6795 89 | Cover Plate - 2*4 Module - Vertical - Sonic Silver | 1428               | 1/5  |
| 6795 92 | Cover Plate - 12 Module - Sonic Silver             | 1728               | 1/5  |
| 6795 96 | Cover Plate - 16 Module - Sonic Silver             | 2010               | 1/5  |
| 6795 97 | Cover Plate - 16 Module(Big) - Sonic Silver        | 2134               | 1/5  |
| 679598  | Cover Plate - 18 Module - Sonic Silver             | 2314               | 1/5  |

#### Dark Fade Cover Plates with Support Frame

|         |   |      |        |
|---------|---|------|--------|
| 6796 01 | Cover Plate - 1 Module - Dark Fade              | 480  | 1/5/30 |
| 6796 02 | Cover Plate - 2 Module - Dark Fade              | 508  | 1/5/30 |
| 6796 03 | Cover Plate - 3 Module - Dark Fade              | 540  | 1/20   |
| 6796 04 | Cover Plate - 4 Module - Dark Fade              | 584  | 1/20   |
| 6796 06 | Cover Plate - 6 Module - Dark Fade              | 1044 | 1/10   |
| 6796 08 | Cover Plate - 8 Module - Horizontal - Dark Fade | 1140 | 1/10   |
| 6796 09 | Cover Plate - 2*4 Module - Vertical - Dark Fade | 1428 | 1/5    |
| 6796 12 | Cover Plate - 12 Module - Dark Fade             | 1728 | 1/5    |
| 6796 16 | Cover Plate - 16 Module - Dark Fade             | 2010 | 1/5    |
| 6796 17 | Cover Plate - 16 Module(Big) - Dark Fade        | 2134 | 1/5    |
| 6796 18 | Cover Plate - 18 Module - Dark Fade             | 2314 | 1/5    |

#### Ice Graphite Cover Plates with Support Frame

|         |  |      |        |
|---------|--|------|--------|
| 6797 21 | Cover Plate - 1 Module - Ice Graphite              | 352  | 1/5/30 |
| 6797 22 | Cover Plate - 2 Module - Ice Graphite              | 372  | 1/5/30 |
| 6797 23 | Cover Plate - 3 Module - Ice Graphite              | 396  | 1/20   |
| 6797 24 | Cover Plate - 4 Module - Ice Graphite              | 422  | 1/20   |
| 6797 26 | Cover Plate - 6 Module - Ice Graphite              | 766  | 1/10   |
| 6797 28 | Cover Plate - 8 Module - Horizontal - Ice Graphite | 834  | 1/10   |
| 6797 29 | Cover Plate - 2*4 Module - Vertical - Ice Graphite | 1046 | 1/5    |
| 6797 32 | Cover Plate - 12 Module - Ice Graphite             | 1264 | 1/5    |
| 6797 36 | Cover Plate - 16 Module - Ice Graphite             | 1476 | 1/5    |
| 6797 37 | Cover Plate - 16 Module(Big) - Ice Graphite        | 1566 | 1/5    |
| 6797 38 | Cover Plate - 18 Module - Ice Graphite             | 1694 | 1/5    |

\* MRP - Maximum Retail Price Inclusive of all taxes including GST.

Bold Cat.Nos are products normally available with Legrand (India) Stockists. Cat.Nos that are not bold - delivery within 4 - 8 weeks from the date of order. Bold packing quantity is our mandatory packing. Orders to be placed by Legrand (India) Stockist in multiples of the same.

## Myrius™ Cover Plates

| Cat.Nos | Description | MRP<br>₹ /<br>Unit | Pack |
|---------|-------------|--------------------|------|
|---------|-------------|--------------------|------|

### Ice Silk Cover Plates with Support Frame

|         |  |      |        |
|---------|--|------|--------|
| 6797 41 | Cover Plate - 1 Module - Ice Silk              | 352  | 1/5/30 |
| 6797 42 | Cover Plate - 2 Module - Ice Silk              | 372  | 1/5/30 |
| 6797 43 | Cover Plate - 3 Module - Ice Silk              | 396  | 1/20   |
| 6797 44 | Cover Plate - 4 Module - Ice Silk              | 422  | 1/20   |
| 6797 46 | Cover Plate - 6 Module - Ice Silk              | 766  | 1/10   |
| 6797 48 | Cover Plate - 8 Module - Horizontal - Ice Silk | 834  | 1/10   |
| 6797 49 | Cover Plate - 2*4 Module - Vertical - Ice Silk | 1046 | 1/5    |
| 6797 62 | Cover Plate - 12 Module - Ice Silk             | 1264 | 1/5    |
| 6797 56 | Cover Plate - 16 Module - Ice Silk             | 1476 | 1/5    |
| 6797 67 | Cover Plate Big - 16 Module(Big) - Ice Silk    | 1566 | 1/5    |
| 6797 68 | Cover Plate - 18 Module - Ice Silk             | 1694 | 1/5    |

### White Glass Cover Plates with Support Frame

|         |   |      |        |
|---------|---|------|--------|
| 6798 11 | Cover Plate - 1 Module - White Glass              | 1274 | 1/5/30 |
| 6798 12 | Cover Plate - 2 Module - White Glass              | 1296 | 1/5/30 |
| 6798 13 | Cover Plate - 3 Module - White Glass              | 1370 | 1/20   |
| 6798 14 | Cover Plate - 4 Module - White Glass              | 1542 | 1/20   |
| 6798 16 | Cover Plate - 6 Module - White Glass              | 1686 | 1/10   |
| 6798 18 | Cover Plate - 8 Module - Horizontal - White Glass | 1826 | 1/10   |
| 6798 19 | Cover Plate - 2*4 Module - Vertical - White Glass | 2232 | 1/5    |
| 6798 22 | Cover Plate - 12 Module - White Glass             | 2842 | 1/5    |
| 6798 26 | Cover Plate - 16 Module - White Glass             | 5022 | 1/5    |
| 6798 28 | Cover Plate - 18 Module - White Glass             | 6226 | 1/5    |

### Black Glass Cover Plates with Support Frame

|         |   |      |        |
|---------|---|------|--------|
| 6798 31 | Cover Plate - 1 Module - Black Glass              | 1274 | 1/5/30 |
| 6798 32 | Cover Plate - 2 Module - Black Glass              | 1296 | 1/5/30 |
| 6798 33 | Cover Plate - 3 Module - Black Glass              | 1370 | 1/20   |
| 6798 34 | Cover Plate - 4 Module - Black Glass              | 1542 | 1/20   |
| 6798 36 | Cover Plate - 6 Module - Black Glass              | 1686 | 1/10   |
| 6798 38 | Cover Plate - 8 Module - Horizontal - Black Glass | 1826 | 1/10   |

## Myrius™ Cover Plates

| Cat.Nos | Description | MRP<br>₹ /<br>Unit | Pack |
|---------|-------------|--------------------|------|
|---------|-------------|--------------------|------|

### Black Glass Cover Plates with Support Frame

|         |   |      |     |
|---------|---|------|-----|
| 6798 39 | Cover Plate - 2*4 Module - Vertical - Black Glass | 2232 | 1/5 |
| 6798 42 | Cover Plate - 12 Module - Black Glass             | 2842 | 1/5 |
| 6798 46 | Cover Plate - 16 Module - Black Glass             | 5022 | 1/5 |
| 6798 48 | Cover Plate - 18 Module - Black Glass             | 6226 | 1/5 |

### Anti-Bacterial Cover Plates with Support Frame

|         |  |      |        |
|---------|--|------|--------|
| 6793 41 | Cover Plate - 1 Module - Anti-Bacterial-Classic White              | 278  | 20/200 |
| 6793 42 | Cover Plate - 2 Module - Anti-Bacterial-Classic White              | 306  | 20/200 |
| 6793 43 | Cover Plate - 3 Module - Anti-Bacterial-Classic White              | 344  | 10/100 |
| 6793 44 | Cover Plate - 4 Module - Anti-Bacterial-Classic White              | 366  | 10/100 |
| 6793 46 | Cover Plate - 6 Module - Anti-Bacterial-Classic White              | 600  | 5/50   |
| 6793 48 | Cover Plate - 8 Module - Horizontal - Anti-Bacterial-Classic White | 704  | 5/50   |
| 6793 49 | Cover Plate - 2*4 Module - Vertical - Anti-Bacterial-Classic White | 880  | 5/25   |
| 6793 50 | Cover Plate - 9 Module - Anti-Bacterial-Classic White              | 912  | 5/50   |
| 6793 52 | Cover Plate - 12 Module - Anti-Bacterial-Classic White             | 1010 | 10     |
| 6793 56 | Cover Plate - 16 Module - Anti-Bacterial-Classic White             | 1196 | 10     |
| 6793 58 | Cover Plate - 18 Module - Anti-Bacterial-Classic White             | 1334 | 10     |

### Metal Flush Boxes

|         |                                |     |    |
|---------|--------------------------------|-----|----|
| 6890 07 | Metal Flush Box - 1/2 Module   | 170 | 40 |
| 6890 08 | Metal Flush Box - 3 Module     | 170 | 40 |
| 6890 09 | Metal Flush Box - 4 Module     | 226 | 40 |
| 6890 10 | Metal Flush Box - 6 Module     | 358 | 40 |
| 6890 42 | Metal Flush Box - 8 Module     | 416 | 40 |
| 6890 31 | Metal Flush Box - 2*4 Module   | 414 | 20 |
| 6890 29 | Metal Flush Box - 9 Module     | 490 | 20 |
| 6890 11 | Metal Flush Box - 12/16 Module | 624 | 10 |
| 6890 12 | Metal Flush Box - 18/24 Module | 788 | 10 |

\* MRP - Maximum Retail Price Inclusive of all taxes including GST.

Bold Cat.Nos are products normally available with Legrand (India) Stockists. Cat.Nos that are not bold - delivery within 4 - 8 weeks from the date of order. Bold packing quantity is our mandatory packing. Orders to be placed by Legrand (India) Stockist in multiples of the same.

## Myrius™ Mounting Boxes

| Cat.Nos | Description | MRP<br>₹ /<br>Unit | Pack |
|---------|-------------|--------------------|------|
|---------|-------------|--------------------|------|

### Plastic Surface Boxes

|         |                                  |     |       |
|---------|----------------------------------|-----|-------|
| 6733 02 | Plastic Surface Box - 1/2 Module | 100 | 10/50 |
| 6733 03 | Plastic Surface Box - 3 Module   | 114 | 5/35  |
| 6733 04 | Plastic Surface Box - 4 Module   | 134 | 5/25  |
| 6733 06 | Plastic Surface Box - 6 Module   | 172 | 1/10  |
| 6733 08 | Plastic Surface Box - 8 Module   | 254 | 1/5   |
| 6733 05 | Plastic Surface Box - 2*4 Module | 240 | 1/5   |

### Metal Surface Boxes

|         |  |     |     |
|---------|--|-----|-----|
| 6890 21 | Metal Surface Box - 12 Module (2 Rows*6) | 600 | 1/6 |
| 6890 22 | Metal Surface Box - 18 Module (3 Rows*6) | 634 | 1/4 |

## Myrius™

### Guarantee

- The Company, at its discretion, will replace products if they have any manufacturing defect within 10 years for switches (without LED lamp) and power sockets. For all other **Myrius™** wiring accessories the guarantee will be 2 years.
- The above guarantee is applicable when the devices are used in Legrand metal flush boxes. Otherwise the guarantee period will be reduced by 50%.
- The guarantee is only applicable when the products are installed as per the Company's instructions and not tampered in any manner.
- The guarantee states the Company's entire liability. It does not extend to cover consequential loss or damage or installation costs arising from defective products.

Our switches are compliant with revised BIS standard (IS 3854:2023) requirements. Also, our switches are covered additionally for use on Self-Ballasted Lamp (SBL) loads.

### SBL power rating as per IS3854:2023

| Switch Rating    | 6A, 230V~ | 10A, 230V~ | 16A, 230V~ | 20A, 230V~ |
|------------------|-----------|------------|------------|------------|
| SBL power (Watt) | 100 W     | 100 W      | 200 W      | 250 W      |

\* MRP - Maximum Retail Price Inclusive of all taxes including GST.

Bold Cat.Nos are products normally available with Legrand (India) Stockists. Cat.Nos that are not bold - delivery within 4 - 8 weeks from the date of order. Bold packing quantity is our mandatory packing. Orders to be placed by Legrand (India) Stockist in multiples of the same.

# Mylinc™

A little touch of genius

## Reliable Modular Wiring for Devices



Mylinc™ is a modular wiring accessories range designed and manufactured in India for residential and commercial installations. Combining dependable mechanisms with practical design, it delivers reliability, convenience, and aesthetically consistent electrical solutions.

### Features

- Durable mechanisms tested for up to 1 lakh operations
- Installer-friendly design with Linc-Loc™ alignment, front removal, and orientation indicators
- Enhanced safety with finger-proof IP20 terminals and shuttered sockets
- Quality assurance and laser markings, ISI and CE certification

### Benefits

- Ensures long-term reliability with certified and durable components
- Simplifies installation with alignment aids and easy access mechanisms
- Enhances electrical safety through protected terminals and compliant designs
- Supports modern spaces with integrated power, lighting, and connectivity solutions

Scan to know more about the product.



## Product Range



Silver Alu



Pearl White



Dark Bronze



Matt Grey



White



Champagne

## Myline™

### White- Mechanism

| Cat.Nos | Description | MRP*<br>₹ / Unit | Pack |
|---------|-------------|------------------|------|
|---------|-------------|------------------|------|

#### Switches and Accessories

##### Switches 6A - 230V AC

|         |  |     |        |
|---------|--|-----|--------|
| 6755 01 | 6A - Switch - SP - 1 Way - 1 Module                  | 112 | 20/400 |
| 6755 02 | 6A - Switch - SP - 2 Way - 1 Module                  | 226 | 20/200 |
| 6755 03 | 6A - Switch - SP - 1 Way - with Indicator - 1 Module | 254 | 20/200 |

##### Switches - 10A - 230V AC

|         |  |     |        |
|---------|--|-----|--------|
| 6755 85 | 10A - Switch - 1 Way - 1 Module                  | 122 | 20/400 |
| 675593  | 10A - Switch - 2 Way - 1 Module                  | 236 | 20/200 |
| 675594  | 10A - Switch - 1 Way - with Indicator - 1 Module | 266 | 20/200 |

##### Switches 16A - 230V AC

|         |   |     |        |
|---------|---|-----|--------|
| 6755 11 | 16A - Switch - SP - 1 Way - 1 Module                  | 256 | 20/200 |
| 6755 12 | 16A - Switch - SP - 2 Way - 1 Module                  | 322 | 20/200 |
| 6755 13 | 16A - Switch - SP - 1 Way - with Indicator - 1 Module | 336 | 20/200 |

##### Switch 25A - 230V AC

|         |  |     |        |
|---------|--|-----|--------|
| 6759 68 | 25A - Switch - with Indicator - 1 Module | 518 | 10/100 |
|---------|--|-----|--------|

##### Switches 32A - 230V AC

|         |   |     |        |
|---------|---|-----|--------|
| 6755 26 | 32A - Switch - DP - 1 Way - with Indicator - 2 Module | 764 | 10/100 |
|---------|---|-----|--------|

##### Push buttons 6A - 230V AC

|         |   |     |        |
|---------|---|-----|--------|
| 6755 04 | 6A - Bell Push - SP - 1 Way - 1 Module                  | 236 | 20/200 |
| 6755 06 | 6A - Bell Push - SP - 1 Way - with Indicator - 2 Module | 468 | 10/100 |

##### Indian Standard Sockets

|         |  |     |        |
|---------|--|-----|--------|
| 6755 51 | 6A - Socket - with Shutter - 3 Pin - ISI - 2 Module              | 310 | 20/200 |
| 6755 55 | 6/16A - Socket - with Shutter - 3 Pin - Combine - ISI - 2 Module | 476 | 10/100 |

##### Bell Call Indicator & Register - 6A - 230V AC

|         |  |      |        |
|---------|--|------|--------|
| 6755 07 | 6A - Bell Call Indicator - SP - with Register - 1 Way - 1 Module | 1378 | 20/200 |
|---------|--|------|--------|

##### Lighting Modules

|         |                                   |     |        |
|---------|-----------------------------------|-----|--------|
| 6755 95 | Indicator Light Red - 1 Module    | 326 | 20/200 |
| 6755 96 | Indicator Light Orange - 1 Module | 326 | 20/200 |

##### Skirting Light

|         |  |      |        |
|---------|--|------|--------|
| 6755 97 | Skirting Light - with White LED - 3 Module | 1044 | 10/100 |
| 6759 76 | Skirting Light - with White LED - 2 Module | 696  | 5/50   |

## Myline™

### White- Mechanism

| Cat.Nos | Description | MRP*<br>₹ / Unit | Pack |
|---------|-------------|------------------|------|
|---------|-------------|------------------|------|

#### Dimmers and Fan Regulators

|         |   |      |          |
|---------|---|------|----------|
| 6755 35 | Rotative Dimmer - 60/250 Watts - for Light - 2 Module             | 868  | 10/100   |
| 6755 33 | Dimmer - 400 Watts - for Light - 1 Module                         | 1102 | 1/5/50   |
| 6755 31 | Fan Regulator - 100 Watts - Humfree - 0 - 4 Step - 1 Module       | 794  | 1/5/50   |
| 6759 64 | Fan Regulator - 100 Watts - with 360° Rotation - ISI - 2 Module   | 986  | 10/100   |
| 6755 30 | Fan Regulator - 100 Watts - Humfree - 0 - 4 Step - ISI - 2 Module | 1062 | 10/100   |
| 6759 77 | Fan Regulator - 8 Step ISI - 2 Module                             | 1062 | 1/10/100 |
| 6759 78 | Fan Regulator - BLDC - 2 Module <sup>^</sup>                      | 1082 | 10/100   |

#### Buzzer

|         |                   |     |        |
|---------|-------------------|-----|--------|
| 6755 40 | Buzzer - 1 Module | 786 | 20/200 |
|---------|-------------------|-----|--------|

#### Remote Unit

|         |  |      |        |
|---------|--|------|--------|
| 6759 75 | Remote Control Unit with Remote - for 4 Switch & Fan Load - 4 Module | 5370 | 1/5/20 |
|---------|--|------|--------|

#### Hospitality function

##### Hotel "DND and MMR" functions

|         |   |     |          |
|---------|---|-----|----------|
| 6759 69 | External DND & MMR Control Unit - with Bell Push - 2 Module | 492 | 10/100   |
| 6755 57 | Internal DND & MMR Control Unit - 2 Module                  | 406 | 1/10/100 |

#### Hotel Keycard Switch

|         |                                |      |          |
|---------|--------------------------------|------|----------|
| 6755 60 | 15A Key Card Switch - 2 Module | 4470 | 1/10     |
| 6730 38 | Key Fob for Key Card Switch    | 298  | 1/10/100 |

#### Motor Starter

|         |                                |     |          |
|---------|--------------------------------|-----|----------|
| 6759 65 | 16A - Motor Starter - 2 Module | 848 | 1/10/100 |
|---------|--------------------------------|-----|----------|

#### Modular MCB (IS : 60898-1:2002)

|         |                                   |     |          |
|---------|-----------------------------------|-----|----------|
| 6759 74 | 16A - SP - Modular MCB - 1 Module | 562 | 1/10/100 |
| 6756 40 | 20A - SP - Modular MCB - 1 Module | 562 | 1/10/100 |
| 6756 41 | 25A - SP - Modular MCB - 1 Module | 562 | 1/10/100 |
| 6756 42 | 32A - SP - Modular MCB - 1 Module | 562 | 1/10/100 |

#### Tv Sockets

|         |                                 |     |        |
|---------|---------------------------------|-----|--------|
| 6755 46 | TV Co - axial Socket - 1 Module | 264 | 20/200 |
|---------|---------------------------------|-----|--------|

\* MRP - Maximum Retail Price Inclusive of all taxes including GST.

<sup>^</sup>Compatible with Atomberg (Efficio), Havells (Efficiencia neo), Orient (Aerostorm) as per 2023 fan models.

Bold Cat.Nos are products normally available with Legrand (India) Stockists. Cat.Nos that are not bold - delivery within 4 - 8 weeks from the date of order. Bold packing quantity is our mandatory packing. Orders to be placed by Legrand (India) Stockist in multiples of the same.

## Mylinc™

### White- Mechanism

| Cat.Nos | Description | MRP*<br>₹ / Unit | Pack |
|---------|-------------|------------------|------|
|---------|-------------|------------------|------|

#### Data and Voice

|         |  |     |        |
|---------|--|-----|--------|
| 6755 41 | Telephone Socket - RJ11 - 1 Module                               | 248 | 20/200 |
| 6755 44 | Telephone Socket - Double RJ11 - 1 Module                        | 416 | 20/200 |
| 6759 66 | Information Socket - RJ45 - Cat 5E -UTP-with Shutter - 1 Module  | 562 | 20/200 |
| 6759 67 | Information Socket - RJ45 - Cat 6 - UTP-with Shutter - 1 Module  | 818 | 20/200 |
| 675982  | Information Socket - RJ45 - Cat 6A - STP with shutter - 1 Module | 929 | 20/200 |

#### USB Chargers (IS13252(Part 1) / IEC 60950-1)

|         |   |      |          |
|---------|---|------|----------|
| 6758 20 | USB Charger - 1500mA - Type A - 1 Module                        | 1412 | 10/100   |
| 6755 80 | Double USB Charger - 3000mA - Type A + C - 2 Module             | 3084 | 1/10/100 |
| 6757 95 | USB Charger - Power Delivery - 30 Watts - Type C + C - 2 Module | 6720 | 1/3/30   |
| 6757 96 | USB Charger - Power Delivery - 45 Watts - Type C - 2 Module     | 8408 | 1/3/30   |

#### Accessories

|         |                               |     |        |
|---------|-------------------------------|-----|--------|
| 6755 91 | Cable Outlet - 8mm - 1 Module | 224 | 20/200 |
| 6755 90 | Blanking Plate - 1 Module     | 64  | 20/200 |
| 6755 92 | Spare 12 Screws with Nuts     | 80  | 20/200 |

#### Modular Cover Plates with Support Frame

##### White Cover Plates with Support Frame

|         |   |      |        |
|---------|---|------|--------|
| 6755 61 | Cover Plate + Support Frame - 1 Module - White              | 186  | 20/200 |
| 6755 62 | Cover Plate + Support Frame - 2 Module - White              | 186  | 20/200 |
| 6755 63 | Cover Plate + Support Frame - 3 Module - White              | 254  | 10/100 |
| 6755 64 | Cover Plate + Support Frame - 4 Module - White              | 282  | 10/100 |
| 6755 66 | Cover Plate + Support Frame - 6 Module - White              | 350  | 5/50   |
| 6755 67 | Cover Plate + Support Frame - Horizontal - 8 Module - White | 450  | 5/50   |
| 6755 68 | Cover Plate + Support Frame - 2*4 Module - Vertical - White | 458  | 1/25   |
| 6755 69 | Cover Plate + Support Frame - 9 Module - White              | 538  | 5/50   |
| 6755 72 | Cover Plate + Support Frame - 12 Module - White             | 660  | 10     |
| 6755 73 | Cover Plate + Support Frame - 16 Module - White             | 770  | 10     |
| 6755 78 | Cover Plate + Support Frame - 18 Module - White             | 1030 | 10     |

\* MRP - Maximum Retail Price Inclusive of all taxes including GST.

## Mylinc™

### Matt Grey- Mechanism

| Cat.Nos | Description | MRP*<br>₹ / Unit | Pack |
|---------|-------------|------------------|------|
|---------|-------------|------------------|------|

#### Switches – 6A - 230V AC

|         |  |     |        |
|---------|--|-----|--------|
| 6763 01 | 6A - Switch - SP - 1 Way - 1 Module                  | 132 | 20/200 |
| 6763 02 | 6A - Switch - SP - 2 Way - 1 Module                  | 244 | 20/200 |
| 6763 03 | 6A - Switch - SP - 1 Way - with Indicator - 1 Module | 286 | 20/200 |

#### Switches – 16A - 230V AC

|         |   |     |        |
|---------|---|-----|--------|
| 6763 11 | 16A - Switch - SP - 1 Way - 1 Module                  | 282 | 20/200 |
| 6763 12 | 16A - Switch - SP - 2 Way - 1 Module                  | 350 | 20/200 |
| 6763 13 | 16A - Switch - SP - 1 Way - with Indicator - 1 Module | 380 | 20/200 |

#### Switches – 25A - 230V AC

|         |  |     |        |
|---------|--|-----|--------|
| 6763 41 | 25A - Switch - with Indicator - 1 Module | 598 | 10/100 |
|---------|--|-----|--------|

#### Switches – 32A - 230V AC

|         |   |     |        |
|---------|---|-----|--------|
| 6763 26 | 32A - Switch - DP - 1 Way - with Indicator - 2 Module | 850 | 10/100 |
|---------|---|-----|--------|

#### Push Buttons – 6A - 230V AC

|         |   |     |        |
|---------|---|-----|--------|
| 6763 04 | 6A - Bell Push - SP - 1 Way - 1 Module                  | 256 | 20/200 |
| 6763 06 | 6A - Bell Push - SP - 1 Way - with Indicator - 2 Module | 520 | 10/100 |

#### Indian Standard Sockets

|         |  |     |        |
|---------|--|-----|--------|
| 6763 27 | 6A - Socket - with Shutter - 3 Pin - ISI - 2 Module              | 344 | 20/200 |
| 6763 05 | 6/16A - Socket - with Shutter - 3 Pin - Combine - ISI - 2 Module | 512 | 10/100 |

#### Bell Call Indicator & Register - 6A - 230V AC

|         |  |      |        |
|---------|--|------|--------|
| 6763 07 | 6A - Bell Call Indicator - SP - with Register - 1 Way - 1 Module | 1520 | 20/200 |
|---------|--|------|--------|

#### Lighting Modules

|         |                                   |     |        |
|---------|-----------------------------------|-----|--------|
| 6763 14 | Indicator Light Red - 1 Module    | 356 | 20/200 |
| 6763 15 | Indicator Light Orange - 1 Module | 356 | 20/200 |

#### Skirting Light

|         |  |      |        |
|---------|--|------|--------|
| 6763 16 | Skirting Light - with White LED - 3 Module | 1142 | 10/100 |
| 6763 10 | Skirting Light - with White LED - 2 Module | 770  | 5/50   |

Bold Cat.Nos are products normally available with Legrand (India) Stockists. Cat.Nos that are not bold - delivery within 4 - 8 weeks from the date of order. Bold packing quantity is our mandatory packing. Orders to be placed by Legrand (India) Stockist in multiples of the same.

## Mylinc™ Matt Grey- Mechanism

| Cat.Nos | Description | MRP*<br>₹ / Unit | Pack |
|---------|-------------|------------------|------|
|---------|-------------|------------------|------|

### Dimmers and Fan Regulators

|         |   |      |          |
|---------|---|------|----------|
| 6763 17 | Rotative Dimmer - 60/250 Watts - for Light - 2 Module             | 958  | 10/100   |
| 6763 18 | Rotative Dimmer - 60/400 Watts - 1 Module                         | 1220 | 1/5/50   |
| 6763 20 | Fan Regulator - 100 Watts - Humfree - 0 - 4 Step - 1 Module       | 868  | 1/5/50   |
| 6763 37 | Fan Regulator - 100 Watts - with 360° Rotation - ISI - 2 Module   | 1084 | 10/100   |
| 6763 19 | Fan Regulator - 100 Watts - Humfree - 0 - 4 Step - ISI - 2 Module | 1166 | 10/100   |
| 6763 08 | Fan Regulator - 8 Step - ISI - 2 Module                           | 1162 | 1/10/100 |
| 6763 09 | Fan Regulator - BLDC - 2 Module^                                  | 1184 | 10/100   |

### Buzzer

|         |                   |     |        |
|---------|-------------------|-----|--------|
| 6763 21 | Buzzer - 1 Module | 964 | 20/200 |
|---------|-------------------|-----|--------|

### Remote Unit

|         |  |      |        |
|---------|--|------|--------|
| 6763 47 | Remote Control Unit with Remote - for 4 Switch & Fan Load - 4 Module | 5908 | 1/5/20 |
|---------|--|------|--------|

### Hospitality Function

#### Hotel "DND and MMR" functions

|         |   |     |        |
|---------|---|-----|--------|
| 6763 42 | External DND & MMR Control Unit - with Bell Push - 2 Module | 540 | 10/100 |
| 6763 23 | Internal DND & MMR Control Unit - 2 Module                  | 472 | 10/100 |

### Hotel Keycard Switch

|         |                                |      |          |
|---------|--------------------------------|------|----------|
| 6736 24 | 15A Key Card Switch - 2 Module | 4960 | 1/10     |
| 673038  | Key Fob for Key Card Switch    | 298  | 1/10/100 |

### Protection Devices

#### Motor Starter

|         |                                |     |          |
|---------|--------------------------------|-----|----------|
| 6763 38 | 16A - Motor Starter - 2 Module | 938 | 1/10/100 |
|---------|--------------------------------|-----|----------|

### Modular MCB (IS : 60898-1:2002)

|         |                                   |     |          |
|---------|-----------------------------------|-----|----------|
| 6763 46 | 16A - SP - Modular MCB - 1 Module | 628 | 1/10/100 |
|---------|-----------------------------------|-----|----------|

### Tv Sockets

|         |                                 |     |        |
|---------|---------------------------------|-----|--------|
| 6763 32 | TV Co - axial Socket - 1 Module | 302 | 20/200 |
|---------|---------------------------------|-----|--------|

\* MRP - Maximum Retail Price Inclusive of all taxes including GST.  
^Compatible with Atomberg (Efficio), Havells (Efficiencia neo), Orient (Aerostorm) as per 2023 fan models.

## Mylinc™ Matt Grey- Mechanism

| Cat.Nos | Description | MRP*<br>₹ / Unit | Pack |
|---------|-------------|------------------|------|
|---------|-------------|------------------|------|

### Data and Voice

|         |  |      |        |
|---------|--|------|--------|
| 6763 33 | Telephone Socket - RJ11 - 1 Module                               | 270  | 20/200 |
| 6763 34 | Telephone Socket - Double RJ11 - 1 Module                        | 446  | 20/200 |
| 6763 39 | Information Socket - RJ45 - Cat 5E -UTP-with Shutter - 1 Module  | 603  | 20/200 |
| 6763 40 | Information Socket - RJ45 - Cat 6 - UTP-with Shutter - 1 Module  | 924  | 20/200 |
| 675983  | Information Socket - RJ45 - Cat 6A - STP with shutter - 1 Module | 1072 | 20/200 |

### USB Chargers (IS13252(Part 1) / IEC 60950-1)

|         |   |      |          |
|---------|---|------|----------|
| 6758 21 | USB Charger - 1500mA - Type A - 1 Module                        | 1554 | 10/100   |
| 6764 80 | Double USB Charger - 3000mA - Type A + C - 2 Module             | 3538 | 1/10/100 |
| 6766 56 | USB Charger - Power Delivery - 30 Watts - Type C + C - 2 Module | 7232 | 1/3/30   |
| 6766 57 | USB Charger - Power Delivery - 45 Watts - Type C - 2 Module     | 9402 | 1/3/30   |

### Accessories

|         |                               |     |        |
|---------|-------------------------------|-----|--------|
| 6763 48 | Cable Outlet - 8mm - 1 Module | 256 | 20/200 |
| 6763 49 | Blanking Plate - 1 Module     | 72  | 20/200 |

Bold Cat.Nos are products normally available with Legrand (India) Stockists. Cat.Nos that are not bold - delivery within 4 - 8 weeks from the date of order. Bold packing quantity is our mandatory packing. Orders to be placed by Legrand (India) Stockist in multiples of the same.

## Myline™ Cover Plate

| Cat.Nos | Description | MRP*<br>₹ /<br>Unit | Pack |
|---------|-------------|---------------------|------|
|---------|-------------|---------------------|------|

### Modular Cover Plates with Support Frame Matt Grey Cover Plates with Support Frame

|         |   |      |        |
|---------|---|------|--------|
| 6763 50 | Cover Plate + Support Frame - 1 Module - Matt Grey              | 242  | 20/200 |
| 6763 51 | Cover Plate + Support Frame - 2 Module - Matt Grey              | 242  | 20/200 |
| 6763 52 | Cover Plate + Support Frame - 3 Module - Matt Grey              | 340  | 10/100 |
| 6763 53 | Cover Plate + Support Frame - 4 Module - Matt Grey              | 358  | 10/100 |
| 6763 54 | Cover Plate + Support Frame - 6 Module - Matt Grey              | 456  | 5/50   |
| 6763 55 | Cover Plate + Support Frame - 8 Module - Horizontal - Matt Grey | 588  | 5/50   |
| 6763 56 | Cover Plate + Support Frame - 2*4 Module - Vertical - Matt Grey | 602  | 5/25   |
| 6763 57 | Cover Plate + Support Frame - 9 Module - Matt Grey              | 700  | 5/50   |
| 6763 58 | Cover Plate + Support Frame - 12 Module - Matt Grey             | 854  | 10     |
| 6763 59 | Cover Plate + Support Frame - 18 Module - Matt Grey             | 1354 | 10     |

### Pearl White Cover Plates with Support Frame

|         |   |      |        |
|---------|---|------|--------|
| 6763 60 | Cover Plate + Support Frame - 1 Module - Pearl White              | 230  | 10/100 |
| 6763 61 | Cover Plate + Support Frame - 2 Module - Pearl White              | 230  | 10/100 |
| 6763 62 | Cover Plate + Support Frame - 3 Module - Pearl White              | 304  | 10/100 |
| 6763 63 | Cover Plate + Support Frame - 4 Module - Pearl White              | 332  | 10/100 |
| 6763 64 | Cover Plate + Support Frame - 6 Module - Pearl White              | 436  | 5/50   |
| 6763 65 | Cover Plate + Support Frame - 8 Module - Horizontal - Pearl White | 550  | 5/50   |
| 6763 66 | Cover Plate + Support Frame - 2*4 Module - Vertical - Pearl White | 562  | 5/25   |
| 6763 67 | Cover Plate + Support Frame - 9 Module - Pearl White              | 644  | 5/50   |
| 6763 68 | Cover Plate + Support Frame - 12 Module - Pearl White             | 794  | 5/25   |
| 6763 69 | Cover Plate + Support Frame - 18 Module - Pearl White             | 1244 | 5/25   |

## Myline™ Cover Plate

| Cat.Nos | Description | MRP*<br>₹ /<br>Unit | Pack |
|---------|-------------|---------------------|------|
|---------|-------------|---------------------|------|

### Champagne Cover Plates with Support Frame

|         |   |      |        |
|---------|---|------|--------|
| 6763 70 | Cover Plate + Support Frame - 1 Module - Champagne              | 230  | 10/100 |
| 6763 71 | Cover Plate + Support Frame - 2 Module - Champagne              | 230  | 10/100 |
| 6763 72 | Cover Plate + Support Frame - 3 Module - Champagne              | 304  | 10/100 |
| 6763 73 | Cover Plate + Support Frame - 4 Module - Champagne              | 332  | 10/100 |
| 6763 74 | Cover Plate + Support Frame - 6 Module - Champagne              | 436  | 5/50   |
| 6763 75 | Cover Plate + Support Frame - 8 Module - Horizontal - Champagne | 550  | 5/50   |
| 6763 76 | Cover Plate + Support Frame - 2*4 Module - Vertical - Champagne | 562  | 5/25   |
| 6763 77 | Cover Plate + Support Frame - 9 Module - Champagne              | 644  | 5/50   |
| 6763 78 | Cover Plate + Support Frame - 12 Module - Champagne             | 794  | 5/25   |
| 6763 79 | Cover Plate + Support Frame - 18 Module - Champagne             | 1244 | 5/25   |

### Silver Alu Cover Plates with Support Frame

|         |  |      |        |
|---------|--|------|--------|
| 6763 80 | Cover Plate + Support Frame - 1 Module - Silver Alu              | 230  | 10/100 |
| 6763 81 | Cover Plate + Support Frame - 2 Module - Silver Alu              | 230  | 10/100 |
| 6763 82 | Cover Plate + Support Frame - 3 Module - Silver Alu              | 304  | 10/100 |
| 6763 83 | Cover Plate + Support Frame - 4 Module - Silver Alu              | 332  | 10/100 |
| 6763 84 | Cover Plate + Support Frame - 6 Module - Silver Alu              | 436  | 5/50   |
| 6763 85 | Cover Plate + Support Frame - 8 Module - Horizontal - Silver Alu | 550  | 5/50   |
| 6763 86 | Cover Plate + Support Frame - 2*4 Module - Vertical - Silver Alu | 562  | 5/25   |
| 6763 87 | Cover Plate + Support Frame - 9 Module - Silver Alu              | 644  | 5/50   |
| 6763 88 | Cover Plate + Support Frame - 12 Module - Silver Alu             | 794  | 5/25   |
| 6763 89 | Cover Plate + Support Frame - 18 Module - Silver Alu             | 1244 | 5/25   |

\* MRP - Maximum Retail Price Inclusive of all taxes including GST.

Bold Cat.Nos are products normally available with Legrand (India) Stockists. Cat.Nos that are not bold - delivery within 4 - 8 weeks from the date of order. Bold packing quantity is our mandatory packing. Orders to be placed by Legrand (India) Stockist in multiples of the same.

## Myline™ Cover Plate

| Cat.Nos  | Description   | MRP*<br>₹ / Unit | Pack   |
|--|---|------------------|--------|
| <b>Dark Bronze Cover Plates with Support Frame</b> |   |                  |        |
| 6763 90  | Cover Plate + Support Frame - 1 Module - Dark Bronze              | 230              | 10/100 |
| 6763 91  | Cover Plate + Support Frame - 2 Module - Dark Bronze              | 230              | 10/100 |
| 6763 92  | Cover Plate + Support Frame - 3 Module - Dark Bronze              | 304              | 10/100 |
| 6763 93  | Cover Plate + Support Frame - 4 Module - Dark Bronze              | 332              | 10/100 |
| 6763 94  | Cover Plate + Support Frame - 6 Module - Dark Bronze              | 436              | 5/50   |
| 6763 95  | Cover Plate + Support Frame - 8 Module - Horizontal - Dark Bronze | 550              | 5/50   |
| 6763 96  | Cover Plate + Support Frame - 2*4 Module - Vertical - Dark Bronze | 562              | 5/25   |
| 6763 97  | Cover Plate + Support Frame - 9 Module - Dark Bronze              | 644              | 5/50   |
| 6763 98  | Cover Plate + Support Frame - 12 Module - Dark Bronze             | 794              | 5/25   |
| 6763 99  | Cover Plate + Support Frame - 18 Module - Dark Bronze             | 1244             | 5/25   |

### Modular White Surrounds

|         |                                      |     |        |
|---------|--------------------------------------|-----|--------|
| 6755 81 | Modular Surrounds - 1 Module - White | 60  | 20/200 |
| 6755 82 | Modular Surrounds - 2 Module - White | 96  | 20/200 |
| 6755 83 | Modular Surrounds - 3 Module - White | 96  | 10/100 |
| 6755 84 | Modular Surrounds - 4 Module - White | 148 | 10/100 |
| 6755 86 | Modular Surrounds - 6 Module - White | 216 | 10/100 |
| 6755 89 | Modular Surrounds - 9 Module - White | 368 | 10/100 |

## Myline™ Boxes

| Cat.Nos                  | Description                    | MRP*<br>₹ / Unit | Pack |
|--------------------------|--------------------------------|------------------|------|
| <b>Accessories</b>       |                                |                  |      |
| <b>Metal Flush Boxes</b> |                                |                  |      |
| 6890 07                  | Metal Flush Box - 1/2 Module   | 170              | 40   |
| 6890 08                  | Metal Flush Box - 3 Module     | 170              | 40   |
| 6890 09                  | Metal Flush Box - 4 Module     | 226              | 40   |
| 6890 10                  | Metal Flush Box - 6 Module     | 358              | 40   |
| 6890 42                  | Metal Flush Box - 8 Module     | 416              | 40   |
| 6890 31                  | Metal Flush Box - 2*4 Module   | 414              | 20   |
| 6890 29                  | Metal Flush Box - 9 Module     | 490              | 20   |
| 6890 11                  | Metal Flush Box - 12/16 Module | 624              | 10   |
| 6890 13                  | Metal Flush Box - 16 Module    | 720              | 10   |
| 6890 12                  | Metal Flush Box - 18 Module    | 788              | 10   |

### Plastic Surface Boxes

|         |                                  |     |       |
|---------|----------------------------------|-----|-------|
| 6733 02 | Plastic Surface Box - 1/2 Module | 100 | 10/50 |
| 6733 03 | Plastic Surface Box - 3 Module   | 114 | 5/35  |
| 6733 04 | Plastic Surface Box - 4 Module   | 134 | 5/25  |
| 6733 06 | Plastic Surface Box - 6 Module   | 172 | 1/10  |
| 6733 08 | Plastic Surface Box - 8 Module   | 254 | 1/5   |
| 6733 05 | Plastic Surface Box - 2*4 Module | 240 | 1/5   |
| 6740 99 | Plastic Surface Box - 9 Module   | 286 | 1/5   |

### Metal Surface Boxes

|         |  |     |     |
|---------|--|-----|-----|
| 6890 21 | Metal Surface Box - 12 Module (2 Rows*6) | 600 | 1/6 |
| 6890 22 | Metal Surface Box - 18 Module (3 Rows*6) | 634 | 1/4 |

\* MRP - Maximum Retail Price Inclusive of all taxes including GST.

**Bold Cat.Nos** are products normally available with Legrand (India) Stockists. Cat.Nos that are not bold - delivery within 4 - 8 weeks from the date of order. **Bold packing quantity** is our mandatory packing. Orders to be placed by Legrand (India) Stockist in multiples of the same.

# Mylinc<sup>TM</sup>

A little touch of genius

A LITTLE TOUCH OF GENIUS



## Guarantee

- The Company, at its discretion, will replace products if they have any manufacturing defect within 10 years for switches (without LED lamp) and power sockets. For all other **Mylinc<sup>TM</sup>** wiring accessories the guarantee will be 2 years.
- The above guarantee is applicable when the devices are used in Legrand metal flush boxes. Otherwise the guarantee period will be reduced by 50%.
- The guarantee is only applicable when the products are installed as per the Company's instructions and not tampered in any manner.
- The guarantee states the Company's entire liability. It does not extend to cover consequential loss or damage or installation costs arising from defective products.

Our switches are compliant with revised BIS standard (IS 3854:2023) requirements. Also, our switches are covered additionally for use on Self-Ballasted Lamp (SBL) loads.

### SBL power rating as per IS3854:2023

| Switch Rating    | 6A, 230V~ | 10A, 230V~ | 16A, 230V~ | 20A, 230V~ |
|------------------|-----------|------------|------------|------------|
| SBL power (Watt) | 100 W     | 100 W      | 200 W      | 250 W      |

# Lyncus<sup>TM</sup>

Upgrade to new

## Elevate Your Home Experience



Lyncus<sup>TM</sup> is a contemporary modular wiring range designed for modern homes. With minimalist styling and versatile modules for power, control, and connectivity, it delivers practical solutions for everyday electrical needs.

### Features

- Smart aesthetics with a signature notch that defines modern minimalism
- Switch range from 6–32A with indicator options
- Universally adaptable modules covering lighting, sockets, BLDC Fan regulator, USB charging, data communication, hospitality, and more.
- High durability design rated for long operational life cycles

### Benefits

- Ensures dependable performance with high-quality engineering and long-term reliability
- Enhances interiors with a sleek and contemporary design
- Simplifies installation with user-friendly, tool-free fitting
- Enables design customization with a range of premium colour finishes

Scan to know more about the product.

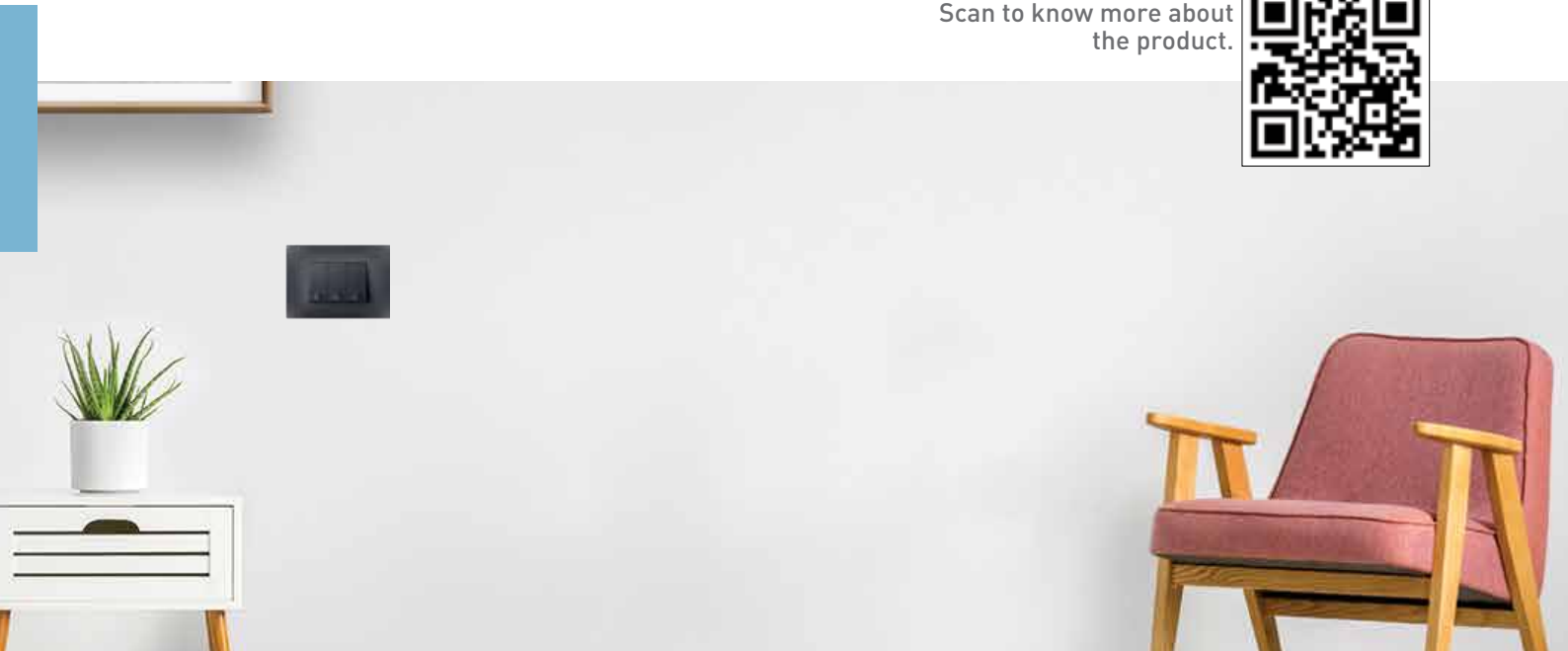

# Lyncus<sup>M</sup>

Upgrade to new

## Upgrade Your Home



White



Brushed Silver



Alu Sunset

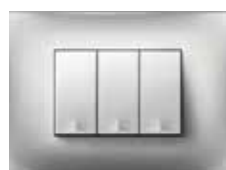

Champagne



Matt Silver



Usb Type C  
- 20W PD  
Fast Charging



USB Type A + C  
- 15W



USB Type C + C  
- 30W PD  
Fast Charging



Remote Control Unit



Bluetooth Sound  
Receiver



6/16A Socket  
with Shutter (ISI)



Touch Fan  
Regulator



Universal  
Touch Dimmer



One Way  
Touch Switch

## Lyncus™

### White Mechanism

| Cat.Nos | Description | MRP*<br>₹ / Unit | Pack |
|---------|-------------|------------------|------|
|---------|-------------|------------------|------|

#### Switches - 6A - 230V AC

|         |   |     |        |
|---------|---|-----|--------|
| 6772 00 | 6A - Switch - 1 Way - 1 Module                        | 98  | 20/200 |
| 6772 01 | 6A - Switch - 2 Way - 1 Module                        | 204 | 20/200 |
| 6772 02 | 6A - Switch - 1 Way - with Indicator - 1 Module       | 204 | 20/200 |
| 6772 03 | 6A - Switch - 1 Way - with "Light" Marking - 1 Module | 184 | 20/200 |
| 6772 04 | 6A - Switch - 1 Way - with "Fan" Marking - 1 Module   | 184 | 20/200 |

#### Switches - 10A - 230V AC

|         |  |      |        |
|---------|--|------|--------|
| 6773 01 | 10A - Switch - 1 Way - 1 Module                  | 106  | 20/200 |
| 6773 02 | 10A - Switch - 2 Way - 1 Module                  | 208  | 20/200 |
| 6773 07 | 10A - Switch - 1 Way - with Indicator - 1 Module | 208  | 20/200 |
| 6772 05 | 10A - Switch - 1 Way - 2 Module                  | 244  | 10/100 |
| 6772 06 | 10A - Switch - 2 Way - 2 Module                  | 292  | 10/100 |
| 6772 07 | 10A - Intermediate Switch - 2 Module             | 1666 | 10/100 |
| 6772 08 | 10A - Switch - 1 Way - with Indicator - 2 Module | 320  | 10/100 |

#### Switches - 16A - 230V AC

|         |  |     |        |
|---------|--|-----|--------|
| 6772 09 | 16A - Switch - 1 Way - 1 Module                  | 236 | 20/200 |
| 6772 10 | 16A - Switch - 2 Way - 1 Module                  | 290 | 20/200 |
| 6772 11 | 16A - Switch - 1 Way - with Indicator - 1 Module | 300 | 20/200 |

#### Switches - 20A - 230V AC

|         |   |     |        |
|---------|---|-----|--------|
| 6772 12 | 20A - Switch - 1 Way - 1 Module                       | 346 | 20/200 |
| 6772 13 | 20A - Switch - DP - 1 Way - 2 Module                  | 502 | 10/100 |
| 6772 14 | 20A - Switch - DP - 1 Way - with Indicator - 2 Module | 512 | 10/100 |
| 6772 15 | 20A - Switch - 2 Way - 2 Module                       | 568 | 10/100 |

#### Switches - 25A - 230V AC

|         |   |     |        |
|---------|---|-----|--------|
| 6772 16 | 25A - Switch - SP - 1 Way - with Indicator - 1 Module | 358 | 20/200 |
|---------|---|-----|--------|

#### Switches - 32A - 230V AC

|         |   |     |        |
|---------|---|-----|--------|
| 6772 17 | 32A - Switch - DP - with Indicator - 2 Module | 690 | 10/100 |
|---------|---|-----|--------|

#### Push Button - 6A - 230V AC

|         |   |     |        |
|---------|---|-----|--------|
| 6772 18 | 6A - Push Button - SP - 1 Module                  | 168 | 20/200 |
| 6772 19 | 6A - Push Button - SP - with Indicator - 1 Module | 240 | 20/200 |
| 6772 20 | 6A - Bell Push - 1 Module                         | 216 | 20/200 |
| 6772 21 | 6A - Bell Push - with Indicator - 1 Module        | 254 | 20/200 |
| 6772 22 | 6A - Bell Push - 2 Module                         | 290 | 10/100 |
| 6772 23 | 6A - Bell Push - with Indicator - 2 Module        | 432 | 10/100 |

#### Accessory for Switch with Indicator

|         |                            |    |      |
|---------|----------------------------|----|------|
| 6772 24 | LED Indicator for Switches | 54 | 5/50 |
|---------|----------------------------|----|------|

## Lyncus™

### White Mechanism

| Cat.Nos | Description | MRP*<br>₹ / Unit | Pack |
|---------|-------------|------------------|------|
|---------|-------------|------------------|------|

#### Indian Standard Sockets

|         |   |     |        |
|---------|---|-----|--------|
| 6772 35 | 6A - Socket - with Shutter - 3 Pin - ISI - 2 Module     | 202 | 20/200 |
| 6772 30 | 6/16A - Socket - with Shutter - ISI - 2 Module          | 410 | 10/100 |
| 6772 29 | 6/16A - Socket - with Shutter - ISI - 3 Module          | 488 | 5/50   |
| 6772 26 | 16A - Switch + Socket - with Shutter - 3 Pin - 3 Module | 772 | 5/50   |

#### Dimmers & Fan Regulators

|         |   |     |          |
|---------|---|-----|----------|
| 6772 36 | Rotary Light Dimmer - 400 Watts - 1 Module          | 742 | 5/50     |
| 6772 37 | Rotary Light Dimmer - 500 Watts - 2 Module          | 952 | 10/100   |
| 6772 39 | Fan Regulator - 100 Watts - ISI - 1 Module          | 680 | 5/50     |
| 6772 42 | Fan step Regulator - 70 Watts - ISI - 2 Module      | 920 | 1/10/100 |
| 6772 40 | Fan Regulator - 100 Watts - 360° - ISI - 2 Module   | 844 | 10/100   |
| 6772 41 | Fan Regulator - 120 Watts - 360° - ISI - 2 Module   | 960 | 10/100   |
| 6772 44 | Fan Regulator - 8 Step - 100 Watts - ISI - 2 Module | 752 | 10/100   |
| 6772 45 | Fan Regulator - BLDC - 2 Module <sup>^</sup>        | 924 | 10/100   |

#### Emergency Light

|         |   |      |        |
|---------|---|------|--------|
| 6772 43 | Emergency Removable LED Lamp - 2 Module | 3212 | 20/200 |
|---------|---|------|--------|

#### Skirting Light

|         |                                      |     |        |
|---------|--------------------------------------|-----|--------|
| 6772 48 | Skirting Light - with LED - 3 Module | 666 | 10/100 |
|---------|--------------------------------------|-----|--------|

#### Indicator

|         |   |     |        |
|---------|---|-----|--------|
| 6772 97 | Indicator Unit - with Transparent LED & Colored Labels - 1 Module | 470 | 10/100 |
|---------|---|-----|--------|

#### Bell Call Indicator

|         |                                       |      |        |
|---------|---------------------------------------|------|--------|
| 6772 49 | Bell Call Indicator - 240V - 1 Module | 1314 | 20/200 |
|---------|---------------------------------------|------|--------|

#### Buzzer

|         |                          |     |        |
|---------|--------------------------|-----|--------|
| 6772 50 | Buzzer - 230V - 1 Module | 752 | 20/200 |
|---------|--------------------------|-----|--------|

#### Infrared Sensors

|         |   |      |        |
|---------|---|------|--------|
| 6772 51 | Infrared Sensor Switch - 400 Watts - 2 Module | 1714 | 20/200 |
|---------|---|------|--------|

#### Remote Unit

|         |  |      |        |
|---------|--|------|--------|
| 6772 52 | Remote Control Unit - for Light & Fan - 4 Module | 5218 | 1/5/20 |
| 6773 03 | Remote Control Hand Unit                         | 838  | 1/5/30 |

#### Hospitality Function

##### Hotel Keycard Switch

|         |                                  |      |        |
|---------|----------------------------------|------|--------|
| 6772 53 | 15A - Key Card Switch - 2 Module | 4150 | 1/10   |
| 6772 55 | Key Fob for Key Card Switch      | 140  | 10/100 |

##### Hotel "DND and MMR" Functions

|         |   |     |        |
|---------|---|-----|--------|
| 6772 56 | External DND & MMR Control Unit - with Bell Push - 2 Module | 460 | 10/100 |
| 6772 57 | Internal DND & MMR Control Unit - 2 Module                  | 386 | 10/100 |

\* MRP - Maximum Retail Price Inclusive of all taxes including GST.

<sup>^</sup> Compatible with Atomberg (Efficio), Havells (Efficiencia neo), Orient (Aerostorm) as per 2023 fan models.

Red Cat. Nos - New Products

Bold Cat.Nos are products normally available with Legrand (India) Stockists. Cat.Nos that are not bold - delivery within 4 - 8 weeks from the date of order. Bold packing quantity is our mandatory packing. Orders to be placed by Legrand (India) Stockist in multiples of the same.

## Lyncus™

### White Mechanism

| Cat.Nos | Description | MRP*<br>₹ / Unit | Pack |
|---------|-------------|------------------|------|
|---------|-------------|------------------|------|

#### Shaver socket

|         |  |      |        |
|---------|--|------|--------|
| 6772 58 | Shaver Socket - 120/240V - MonoBlock with Plate - 2 Module | 3182 | 20/200 |
|---------|--|------|--------|

#### Sockets & Connectors

##### Tv Sockets

|         |                                 |     |        |
|---------|---------------------------------|-----|--------|
| 6772 60 | TV Co - axial Socket - 1 Module | 230 | 20/200 |
|---------|---------------------------------|-----|--------|

##### Data & voice

|         |  |     |        |
|---------|--|-----|--------|
| 6772 62 | Telephone Socket - RJ11 - 1 Module                               | 216 | 20/200 |
| 6772 63 | Telephone Socket - Double RJ11 - 1 Module                        | 352 | 20/200 |
| 6772 64 | Information Socket - RJ45 - Cat 5 - UTP -with Shutter - 1 Module | 530 | 20/200 |
| 6772 65 | Information Socket - RJ45 - Cat 6 - UTP -with Shutter - 1 Module | 740 | 20/200 |
| 6773 20 | Information Socket - RJ45 - CAT6A - STP with shutter - 1 Module  | 942 | 20/200 |

#### Audio Video Connectors

|         |  |      |      |
|---------|--|------|------|
| 6772 67 | Preterminated Audio/Video Connector - 1 Module | 1731 | 1/10 |
| 6772 68 | Preterminated HDMI Socket - 1 Module           | 2121 | 1/10 |
| 6772 69 | Preterminated Projector Connector - 1 Module   | 2121 | 1/10 |

#### Sound (Volume controller)

|         |                              |      |        |
|---------|------------------------------|------|--------|
| 6772 70 | Volume Controller - 2 Module | 1361 | 10/100 |
|---------|------------------------------|------|--------|

#### Protectors and Accessories

##### Motor Starter

|         |                                |     |        |
|---------|--------------------------------|-----|--------|
| 6772 71 | 16A - Motor Starter - 2 Module | 796 | 1/5/50 |
| 6772 72 | 25A - Motor Starter - 2 Module | 796 | 1/5/50 |

##### VSP

|         |   |      |        |
|---------|---|------|--------|
| 6772 74 | Voltage Surge Protector - 230V - 1 Module | 2654 | 20/200 |
|---------|---|------|--------|

#### Modular MCB (IS : 608981:2002)

|         |                                   |     |          |
|---------|-----------------------------------|-----|----------|
| 6772 81 | 16A - SP - Modular MCB - 1 Module | 546 | 1/10/100 |
| 6772 82 | 20A - SP - Modular MCB - 1 Module | 546 | 1/10/100 |
| 6772 83 | 32A - SP - Modular MCB - 1 Module | 546 | 1/10/100 |

## Lyncus™

### White Mechanism

| Cat.Nos | Description | MRP*<br>₹ / Unit | Pack |
|---------|-------------|------------------|------|
|---------|-------------|------------------|------|

#### Electronic Function

##### USB Chargers (IS13252 (Part 1) / IEC 60950-1)

|                     |   |      |          |
|---------------------|---|------|----------|
| 6772 91             | USB Charger - 1500mA - Type A - 1 Module                        | 1356 | 10/100   |
| 6772 89             | USB Charger - 3000mA - Type A + C - 2 Module                    | 3028 | 1/10/100 |
| 6777 51             | USB Charger - 3000mA/15 Watts - Type A - 1 Module               | 1986 | 1/5/50   |
| 6777 52             | USB Charger - 3000mA/15 Watts - Type A + A - 1 Module           | 2206 | 1/5/50   |
| 6777 53             | USB Charger - 3000mA/15 Watts - Type A + C - 1 Module           | 2526 | 1/5/50   |
| 6777 54             | USB Charger - 3000mA/15 Watts - Type C + C - 1 Module           | 2762 | 1/5/50   |
| 6777 55             | USB Charger - Power Delivery - 20 Watts - Type C - 1 Module     | 3824 | 1/5/50   |
| 6777 56             | USB Charger - Power Delivery - 30 Watts - Type C + C - 2 Module | 6562 | 1/3/30   |
| 6777 57             | USB Charger - Power Delivery - 45W - Type C - 2 Module          | 8034 | 1/3/30   |
| <b>NEW!</b> 6777 59 | USB Charger - Power Delivery - 65W - Type C + C - 3 Module      | 9966 | 1/5/20   |

#### Loud Speakers

|         |  |      |     |
|---------|--|------|-----|
| 6772 98 | Loudspeaker for False Ceiling & Plaster Board - 8Ohms - 10 Watts | 2741 | 1/6 |
|---------|--|------|-----|

#### Sound Diffusion

|          |                                      |      |          |
|----------|--------------------------------------|------|----------|
| 6772 99* | Bluetooth Sound Diffusion - 2 Module | 6033 | 1/10/100 |
|----------|--------------------------------------|------|----------|

#### Rotary Dimmer Universal

|         |   |      |          |
|---------|---|------|----------|
| 6773 04 | Rotary LED Light Dimmer - 50 Watts - 1 Module | 2740 | 1/10/100 |
|---------|---|------|----------|

#### Touch Switches

|         |   |      |      |
|---------|---|------|------|
| 6773 09 | 6A - Touch Switch - 1 Way - 2 Module - Black  | 3782 | 1/50 |
| 6773 10 | 6A - Touch Switch - 2 Way - 2 Module - Black  | 4370 | 1/50 |
| 6773 13 | 16A - Touch Switch - 1 Way - 2 Module - Black | 4370 | 1/50 |
| 6773 06 | 6A - Touch Bell Push - 2 Module - Black       | 3782 | 1/50 |

#### Touch Regulator & Dimmer

|         |   |      |      |
|---------|---|------|------|
| 6773 05 | Touch Fan Regulator - 100 Watts - 2 Module - Black                      | 4370 | 1/50 |
| 6773 15 | Universal LED Touch Light Scroll Dimming - 300 Watts - 2 Module - Black | 4370 | 1/50 |

#### Reading Light

|         |                   |      |        |
|---------|-------------------|------|--------|
| 6773 16 | Reading Light LED | 2524 | 20/200 |
|---------|-------------------|------|--------|

\* MRP - Maximum Retail Price Inclusive of all taxes including GST.  
Red Cat. Nos - New Products

Bold Cat.Nos are products normally available with Legrand (India) Stockists. Cat.Nos that are not bold - delivery within 4 - 8 weeks from the date of order. Bold packing quantity is our mandatory packing. Orders to be placed by Legrand (India) Stockist in multiples of the same.

## Lyncus™

### White Mechanism

| Cat.Nos | Description | MRP*<br>₹ / Unit | Pack |
|---------|-------------|------------------|------|
|---------|-------------|------------------|------|

#### Accessories

|         |   |     |        |
|---------|---|-----|--------|
| 6772 75 | Cable Outlet - 8mm - 1 Module             | 208 | 20/200 |
| 6772 76 | Blanking Plate - 1 Module - Classic White | 54  | 40/400 |
| 6772 77 | Blanking Plate - 2 Module - Classic White | 70  | 10/100 |

#### Chic Grey- Mechanism

##### Switches - 6A - 230V AC

|         |   |     |        |
|---------|---|-----|--------|
| 6774 00 | 6A - Switch - 1 Way - 1 Module                        | 118 | 20/200 |
| 6774 01 | 6A - Switch - 2 Way - 1 Module                        | 236 | 20/200 |
| 6774 02 | 6A - Switch - 1 Way - with Indicator - 1 Module       | 238 | 20/200 |
| 6774 03 | 6A - Switch - 1 Way - with "Light" Marking - 1 Module | 226 | 20/200 |
| 6774 04 | 6A - Switch - 1 Way - with "Fan" Marking - 1 Module   | 226 | 20/200 |

##### Switches - 10A - 230V AC

|         |  |      |        |
|---------|--|------|--------|
| 6774 05 | 10A - Switch - 1 Way - 2 Module                  | 288  | 10/100 |
| 6774 06 | 10A - Switch - 2 Way - 2 Module                  | 338  | 10/100 |
| 6774 07 | 10A - Intermediate Switch - 2 Module             | 1918 | 10/100 |
| 6774 08 | 10A - Switch - 1 Way - with Indicator - 2 Module | 372  | 10/100 |

##### Switches - 16A - 230V AC

|         |  |     |        |
|---------|--|-----|--------|
| 6774 09 | 16A - Switch - 1 Way - 1 Module                  | 260 | 20/200 |
| 6774 10 | 16A - Switch - 2 Way - 1 Module                  | 334 | 20/200 |
| 6774 11 | 16A - Switch - 1 Way - with Indicator - 1 Module | 346 | 20/200 |

##### Switches - 20A - 230V AC

|         |   |     |        |
|---------|---|-----|--------|
| 6774 12 | 20A - Switch - 1 Way - 1 Module                       | 402 | 20/200 |
| 6774 13 | 20A - Switch - DP - 1 Way - 2 Module                  | 580 | 10/100 |
| 6774 14 | 20A - Switch - DP - 1 Way - with Indicator - 2 Module | 588 | 10/100 |
| 6774 15 | 20A - Switch - 2 Way - 2 Module                       | 666 | 10/100 |

##### Switches - 25A - 230V AC

|         |   |     |        |
|---------|---|-----|--------|
| 6774 16 | 25A - Switch - SP - 1 Way - with Indicator - 1 Module | 414 | 20/200 |
|---------|---|-----|--------|

##### Switches - 32A - 230V AC

|         |   |     |        |
|---------|---|-----|--------|
| 6774 17 | 32A - Switch - DP - with Indicator - 2 Module | 794 | 10/100 |
|---------|---|-----|--------|

##### Push Button - 6A - 230V AC

|         |   |     |        |
|---------|---|-----|--------|
| 6774 18 | 6A - Push Button - SP - 1 Module                  | 192 | 20/200 |
| 6774 19 | 6A - Push Button - SP - with Indicator - 1 Module | 272 | 20/200 |
| 6774 20 | 6A - Bell Push - 1 Module                         | 250 | 20/200 |
| 6774 21 | 6A - Bell Push - with Indicator - 1 Module        | 296 | 20/200 |
| 6774 22 | 6A - Bell Push - 2 Module                         | 334 | 10/100 |
| 6774 23 | 6A - Bell Push - with Indicator - 2 Module        | 494 | 10/100 |

## Lyncus™

### Chic Grey Mechanism

| Cat.Nos | Description | MRP*<br>₹ / Unit | Pack |
|---------|-------------|------------------|------|
|---------|-------------|------------------|------|

#### Indian Standard Sockets

|         |   |     |        |
|---------|---|-----|--------|
| 6774 35 | 6A - Socket - with Shutter - 3 Pin - ISI - 2 Module | 232 | 20/200 |
| 6774 30 | 6/16A - Socket - with Shutter - ISI - 2 Module      | 474 | 10/100 |
| 6774 29 | 6/16A - Socket - with Shutter - ISI - 3 Module      | 564 | 5/50   |

#### Dimmers & Fan Regulators

|         |   |      |          |
|---------|---|------|----------|
| 6774 36 | Rotary Light Dimmer - 400 Watts - 1 Module          | 854  | 5/50     |
| 6774 37 | Rotary Light Dimmer - 500 Watts - 2 Module          | 1090 | 10/100   |
| 6774 39 | Fan Regulator - 100 Watts - ISI - 1 Module          | 788  | 5/50     |
| 6774 42 | Fan step Regulator - 70 Watts - ISI - 2 Module      | 1060 | 1/10/100 |
| 6774 40 | Fan Regulator - 100 Watts - 360° - ISI - 2 Module   | 970  | 10/100   |
| 6774 41 | Fan Regulator - 120 Watts - 360° - ISI - 2 Module   | 1102 | 10/100   |
| 6774 44 | Fan Regulator - 8 Step - 100 Watts - ISI - 2 Module | 880  | 10/100   |
| 6774 45 | Fan Regulator - BLDC - 2 Module^                    | 1070 | 10/100   |

#### Skirting Light

|         |                                      |     |        |
|---------|--------------------------------------|-----|--------|
| 6774 48 | Skirting Light - with LED - 3 Module | 752 | 10/100 |
|---------|--------------------------------------|-----|--------|

#### Bell Call Indicator

|         |                                       |      |        |
|---------|---------------------------------------|------|--------|
| 6774 49 | Bell Call Indicator - 240V - 1 Module | 1482 | 20/200 |
|---------|---------------------------------------|------|--------|

#### Buzzer

|         |                          |     |        |
|---------|--------------------------|-----|--------|
| 6774 50 | Buzzer - 230V - 1 Module | 854 | 20/200 |
|---------|--------------------------|-----|--------|

#### Remote Unit

|         |  |      |        |
|---------|--|------|--------|
| 6774 52 | Remote Control Unit - for Light & Fan - 4 Module | 5602 | 1/5/20 |
| 6773 03 | Remote Control Hand Unit                         | 838  | 1/5/30 |

#### Hospitality Function

##### Hotel Keycard Switch

|         |                                  |      |        |
|---------|----------------------------------|------|--------|
| 6774 53 | 15A - Key Card Switch - 2 Module | 4682 | 1/10   |
| 6772 55 | Key Fob for Key Card Switch      | 140  | 10/100 |

##### Hotel "DND and MMR" Functions

|         |   |     |        |
|---------|---|-----|--------|
| 6774 56 | External DND & MMR Control Unit - with Bell Push - 2 Module | 528 | 10/100 |
| 6774 57 | Internal DND & MMR Control Unit - 2 Module                  | 460 | 10/100 |

#### Shaver Socket

|         |  |      |        |
|---------|--|------|--------|
| 6774 58 | Shaver Socket - 120/240V - MonoBlock with Plate - 2 Module | 3560 | 20/200 |
|---------|--|------|--------|

#### TV Sockets

|         |                                 |     |        |
|---------|---------------------------------|-----|--------|
| 6774 60 | TV Co - axial Socket - 1 Module | 262 | 20/200 |
|---------|---------------------------------|-----|--------|

\* MRP - Maximum Retail Price Inclusive of all taxes including GST.

^Compatible with Atomberg (Efficio), Havells (Eficiencia neo), Orient (Aerostorm) as per 2023 fan models.

Bold Cat.Nos are products normally available with Legrand (India) Stockists. Cat.Nos that are not bold - delivery within 4 - 8 weeks from the date of order. Bold packing quantity is our mandatory packing. Orders to be placed by Legrand (India) Stockist in multiples of the same.

## Lyncus™

### Chic Grey Mechanism

| Cat.Nos | Description | MRP*<br>₹ / Unit | Pack |
|---------|-------------|------------------|------|
|---------|-------------|------------------|------|

#### Data & Voice

|         |  |      |        |
|---------|--|------|--------|
| 6774 62 | Telephone Socket - RJ11 - 1 Module                               | 246  | 20/200 |
| 6774 63 | Telephone Socket - Double RJ11 - 1 Module                        | 416  | 20/200 |
| 6774 64 | Information Socket - RJ45 - Cat 5 - UTP -with Shutter - 1 Module | 580  | 20/200 |
| 6774 65 | Information Socket - RJ45 - Cat 6 - UTP -with Shutter - 1 Module | 892  | 20/200 |
| 6773 21 | Information Socket - RJ45 - CAT6A - STP with shutter - 1 Module  | 1023 | 20/200 |

#### Audio Video Sockets

|         |  |      |      |
|---------|--|------|------|
| 6774 67 | Preterminated Audio/Video Connector - 1 Module | 1994 | 1/10 |
| 6774 68 | Preterminated HDMI Socket - 1 Module           | 2438 | 1/10 |
| 6774 69 | Preterminated Projector Connector - 1 Module   | 2438 | 1/10 |

#### Sound (volume controller)

|         |                              |      |          |
|---------|------------------------------|------|----------|
| 6774 70 | Volume Controller - 2 Module | 1572 | 1/10/100 |
|---------|------------------------------|------|----------|

#### Electronic Function

##### USB Chargers (IS13252 (Part 1) / IEC 609501)

|                     |   |       |          |
|---------------------|---|-------|----------|
| 6774 91             | USB Charger - 1500mA - Type A - 1 Module                        | 1540  | 1/5/50   |
| 6774 89             | USB Charger - 3000mA - Type A + C - 2 Module                    | 3480  | 1/10/100 |
| 6779 51             | USB Charger - 3000mA/15 Watts - Type A - 1 Module               | 2214  | 1/5/50   |
| 6779 52             | USB Charger - 3000mA/15 Watts - Type A + A - 1 Module           | 2480  | 1/5/50   |
| 6779 53             | USB Charger - 3000mA/15 Watts - Type A + C - 1 Module           | 2808  | 1/5/50   |
| 6779 54             | USB Charger - 3000mA/15 Watts - Type C + C - 1 Module           | 3066  | 1/5/50   |
| 6779 55             | USB Charger - Power Delivery - 20 Watts - Type C - 1 Module     | 4276  | 1/5/50   |
| 6779 56             | USB Charger - Power Delivery - 30 Watts - Type C + C - 2 Module | 7188  | 1/3/30   |
| 6779 57             | USB Charger - Power Delivery - 45W - Type C - 2 Module          | 8856  | 1/3/30   |
| <b>NEW!</b> 6779 59 | USB Charger - Power Delivery - 65W - Type C + C - 3 Module      | 10526 | 1/5/20   |

#### Sound Receiver

|          |                                      |      |          |
|----------|--------------------------------------|------|----------|
| 6774 99* | Bluetooth Sound Diffusion - 2 Module | 6941 | 1/10/100 |
|----------|--------------------------------------|------|----------|

#### Rotary Dimmer Universal

|         |   |      |       |
|---------|---|------|-------|
| 6774 24 | Rotary LED Dimmer - 50 Watts - 1 Module | 3474 | 1/120 |
|---------|---|------|-------|

#### Accessories

|         |                               |     |        |
|---------|-------------------------------|-----|--------|
| 6774 75 | Cable Outlet - 8mm - 1 Module | 246 | 20/200 |
| 6774 76 | Blanking Plate - 1 Module     | 58  | 40/400 |

## Lyncus™

### Plate with Support Frame

| Cat.Nos | Description | MRP*<br>₹ / Unit | Pack |
|---------|-------------|------------------|------|
|---------|-------------|------------------|------|

#### Cover Plates with Support Frame White Cover Plates with Support Frame

|         |   |     |        |
|---------|---|-----|--------|
| 6775 01 | Cover Plate + Support Frame - 1 Module - Classic White              | 170 | 20/200 |
| 6775 02 | Cover Plate + Support Frame - 2 Module - Classic White              | 170 | 20/200 |
| 6775 03 | Cover Plate + Support Frame - 3 Module - Classic White              | 218 | 10/100 |
| 6775 04 | Cover Plate + Support Frame - 4 Module - Classic White              | 254 | 10/100 |
| 6775 06 | Cover Plate + Support Frame - 6 Module - Classic White              | 308 | 5/50   |
| 6775 08 | Cover Plate + Support Frame - 8 Module - Horizontal - Classic White | 394 | 5/50   |
| 6775 09 | Cover Plate + Support Frame - 2*4 Module - Vertical - Classic White | 412 | 5/25   |
| 6775 10 | Cover Plate + Support Frame - 9 Module - Classic White              | 438 | 5/50   |
| 6775 12 | Cover Plate + Support Frame - 12 Module - Classic White             | 574 | 10     |
| 6775 16 | Cover Plate + Support Frame - 16 Module - Classic White             | 668 | 10     |
| 6776 17 | Cover Plate + Support Frame - 16 Module(Big) - Classic White        | 680 | 10     |
| 6775 18 | Cover Plate + Support Frame - 18 Module - Classic White             | 902 | 10     |

\* MRP - Maximum Retail Price Inclusive of all taxes including GST.  
Red Cat. Nos - New Products

Bold Cat.Nos are products normally available with Legrand (India) Stockists. Cat.Nos that are not bold - delivery within 4 - 8 weeks from the date of order. Bold packing quantity is our mandatory packing. Orders to be placed by Legrand (India) Stockist in multiples of the same.

## Lyncus™

### Plate with Support Frame

| Cat.Nos  | Description   | MRP*<br>₹ /<br>Unit | Pack   |
|--|---|---------------------|--------|
| <b>Chic Grey Cover Plates with Support Frame</b> |   |                     |        |
| 6775 21  | Cover Plate + Support Frame - 1 Module - Chic Grey              | 218                 | 20/200 |
| 6775 22  | Cover Plate + Support Frame - 2 Module - Chic Grey              | 218                 | 20/200 |
| 6775 23  | Cover Plate + Support Frame - 3 Module - Chic Grey              | 304                 | 10/100 |
| 6775 24  | Cover Plate + Support Frame - 4 Module - Chic Grey              | 322                 | 10/100 |
| 6775 26  | Cover Plate + Support Frame - 6 Module - Chic Grey              | 396                 | 5/50   |
| 6775 28  | Cover Plate + Support Frame - 8 Module - Horizontal - Chic Grey | 540                 | 5/50   |
| 6775 29  | Cover Plate + Support Frame - 2*4 Module - Vertical - Chic Grey | 540                 | 5/25   |
| 6775 30  | Cover Plate + Support Frame - 9 Module - Chic Grey              | 582                 | 5/50   |
| 6775 32  | Cover Plate + Support Frame - 12 Module - Chic Grey             | 754                 | 10     |
| 6775 36  | Cover Plate + Support Frame - 16 Module - Chic Grey             | 868                 | 10     |
| 6776 37  | Cover Plate + Support Frame - 16 Module (Big) - Chic Grey       | 874                 | 10     |
| 6775 38  | Cover Plate + Support Frame - 18 Module - Chic Grey             | 1184                | 10     |

## Lyncus™

### Plate with Support Frame

| Cat.Nos   | Description  | MRP*<br>₹ /<br>Unit | Pack   |
|---|--|---------------------|--------|
| <b>Brushed Silver Cover Plates with Support Frame</b> |  |                     |        |
| 6775 41   | Cover Plate + Support Frame - 1 Module - Brushed Silver              | 224                 | 20/200 |
| 6775 42   | Cover Plate + Support Frame - 2 Module - Brushed Silver              | 224                 | 20/200 |
| 6775 43   | Cover Plate + Support Frame - 3 Module - Brushed Silver              | 322                 | 10/100 |
| 6775 44   | Cover Plate + Support Frame - 4 Module - Brushed Silver              | 332                 | 10/100 |
| 6775 46   | Cover Plate + Support Frame - 6 Module - Brushed Silver              | 426                 | 5/50   |
| 6775 48   | Cover Plate + Support Frame - 8 Module - Horizontal - Brushed Silver | 552                 | 5/50   |
| 6775 49   | Cover Plate + Support Frame - 2*4 Module - Vertical - Brushed Silver | 552                 | 5/25   |
| 6775 50   | Cover Plate + Support Frame - 9 Module - Brushed Silver              | 606                 | 5/50   |
| 6775 52   | Cover Plate + Support Frame - 12 Module - Brushed Silver             | 790                 | 10     |
| 6775 56   | Cover Plate + Support Frame - 16 Module - Brushed Silver             | 914                 | 10     |
| 6776 57   | Cover Plate + Support Frame - 16 Module (Big) - Brushed Silver       | 926                 | 10     |
| 6775 58   | Cover Plate + Support Frame - 18 Module - Brushed Silver             | 1244                | 10     |

\* MRP - Maximum Retail Price Inclusive of all taxes including GST.

Bold Cat.Nos are products normally available with Legrand (India) Stockists. Cat.Nos that are not bold - delivery within 4 - 8 weeks from the date of order. Bold packing quantity is our mandatory packing. Orders to be placed by Legrand (India) Stockist in multiples of the same.

## Lyncus™

### Plate with Support Frame

| Cat.Nos  | Description  | MRP*<br>₹ /<br>Unit | Pack   |
|--|--|---------------------|--------|
| <b>Alu Sun Set Cover Plates with Support Frame</b> |  |                     |        |
| 6775 61  | Cover Plate + Support Frame - 1 Module - Alu SunSet              | 220                 | 20/200 |
| 6775 62  | Cover Plate + Support Frame - 2 Module - Alu SunSet              | 220                 | 20/200 |
| 6775 63  | Cover Plate + Support Frame - 3 Module - Alu SunSet              | 304                 | 10/100 |
| 6775 64  | Cover Plate + Support Frame - 4 Module - Alu SunSet              | 330                 | 10/100 |
| 6775 66  | Cover Plate + Support Frame - 6 Module - Alu SunSet              | 418                 | 5/50   |
| 6775 68  | Cover Plate + Support Frame - 8 Module - Horizontal - Alu SunSet | 540                 | 5/50   |
| 6775 69  | Cover Plate + Support Frame - 2*4 Module - Vertical - Alu SunSet | 544                 | 5/25   |
| 6775 70  | Cover Plate + Support Frame - 9 Module - Alu SunSet              | 582                 | 5/50   |
| 6775 72  | Cover Plate + Support Frame - 12 Module - Alu SunSet             | 768                 | 10     |
| 6775 76  | Cover Plate + Support Frame - 16 Module - Alu SunSet             | 888                 | 10     |
| 6776 77  | Cover Plate + Support Frame - 16 Module(Big) - Alu SunSet        | 894                 | 10     |
| 6775 78  | Cover Plate + Support Frame - 18 Module - Alu SunSet             | 1220                | 10     |

## Lyncus™

### Plate with Support Frame

| Cat.Nos  | Description   | MRP*<br>₹ /<br>Unit | Pack   |
|--|---|---------------------|--------|
| <b>Champagne Cover Plates with Support Frame</b> |   |                     |        |
| 6775 81  | Cover Plate + Support Frame - 1 Module - Champagne              | 220                 | 20/200 |
| 6775 82  | Cover Plate + Support Frame - 2 Module - Champagne              | 220                 | 20/200 |
| 6775 83  | Cover Plate + Support Frame - 3 Module - Champagne              | 304                 | 10/100 |
| 6775 84  | Cover Plate + Support Frame - 4 Module - Champagne              | 330                 | 10/100 |
| 6775 86  | Cover Plate + Support Frame - 6 Module - Champagne              | 418                 | 5/50   |
| 6775 88  | Cover Plate + Support Frame - 8 Module - Horizontal - Champagne | 540                 | 5/50   |
| 6775 89  | Cover Plate + Support Frame - 2*4 Module - Vertical - Champagne | 544                 | 5/25   |
| 6775 90  | Cover Plate + Support Frame - 9 Module - Champagne              | 582                 | 5/50   |
| 6775 92  | Cover Plate + Support Frame - 12 Module - Champagne             | 768                 | 10     |
| 6775 96  | Cover Plate + Support Frame - 16 Module - Champagne             | 888                 | 10     |
| 6776 97  | Cover Plate + Support Frame - 16 Module(Big) - Champagne        | 894                 | 10     |
| 6775 98  | Cover Plate + Support Frame - 18 Module - Champagne             | 1220                | 10     |

\* MRP - Maximum Retail Price Inclusive of all taxes including GST.

**Bold Cat.Nos** are products normally available with Legrand (India) Stockists. **Cat.Nos** that are not bold - delivery within 4 - 8 weeks from the date of order. **Bold packing quantity** is our mandatory packing. Orders to be placed by Legrand (India) Stockist in multiples of the same.

## Lyncus™

### Plate with Support Frame

| Cat.Nos  | Description   | MRP*<br>₹ / Unit | Pack   |
|--|---|------------------|--------|
| <b>Matt Silver Cover Plates with Support Frame</b> |   |                  |        |
| 6776 01  | Cover Plate + Support Frame - 1 Module - Matt Silver              | 220              | 20/200 |
| 6776 02  | Cover Plate + Support Frame - 2 Module - Matt Silver              | 220              | 20/200 |
| 6776 03  | Cover Plate + Support Frame - 3 Module - Matt Silver              | 304              | 10/100 |
| 6776 04  | Cover Plate + Support Frame - 4 Module - Matt Silver              | 330              | 10/100 |
| 6776 06  | Cover Plate + Support Frame - 6 Module - Matt Silver              | 418              | 5/50   |
| 6776 08  | Cover Plate + Support Frame - 8 Module - Horizontal - Matt Silver | 540              | 5/50   |
| 6776 09  | Cover Plate + Support Frame - 2*4 Module - Vertical - Matt Silver | 544              | 5/25   |
| 6776 10  | Cover Plate + Support Frame - 9 Module - Matt Silver              | 582              | 5/50   |
| 6776 12  | Cover Plate + Support Frame - 12 Module - Matt Silver             | 768              | 10     |
| 6776 16  | Cover Plate + Support Frame - 16 Module - Matt Silver             | 888              | 10     |
| 6776 67  | Cover Plate + Support Frame - 16 Module(Big) - Matt Silver        | 894              | 10     |
| 6776 18  | Cover Plate + Support Frame - 18 Module - Matt Silver             | 1220             | 10     |

### Accessories

#### Metal Flush Boxes

|         |                                |     |    |
|---------|--------------------------------|-----|----|
| 6890 07 | Metal Flush Box - 1/2 Module   | 170 | 40 |
| 6890 08 | Metal Flush Box - 3 Module     | 170 | 40 |
| 6890 09 | Metal Flush Box - 4 Module     | 226 | 40 |
| 6890 10 | Metal Flush Box - 6 Module     | 358 | 40 |
| 6890 42 | Metal Flush Box - 8 Module     | 416 | 40 |
| 6890 31 | Metal Flush Box - 2*4 Module   | 414 | 20 |
| 6890 29 | Metal Flush Box - 9 Module     | 490 | 20 |
| 6890 11 | Metal Flush Box - 12/16 Module | 624 | 10 |
| 6890 13 | Metal Flush Box - 16 Module    | 720 | 10 |
| 6890 12 | Metal Flush Box - 18 Module    | 788 | 10 |

\* MRP - Maximum Retail Price Inclusive of all taxes including GST.

## Lyncus™

### Boxes

| Cat.Nos | Description | MRP*<br>₹ / Unit | Pack |
|---------|-------------|------------------|------|
|---------|-------------|------------------|------|

#### Plastic Surface Boxes

|         |                                  |     |       |
|---------|----------------------------------|-----|-------|
| 6733 02 | Plastic Surface Box - 1/2 Module | 100 | 10/50 |
| 6733 03 | Plastic Surface Box - 3 Module   | 114 | 5/35  |
| 6733 04 | Plastic Surface Box - 4 Module   | 134 | 5/25  |
| 6733 06 | Plastic Surface Box - 6 Module   | 172 | 1/10  |
| 6733 08 | Plastic Surface Box - 8 Module   | 254 | 1/5   |
| 6733 05 | Plastic Surface Box - 2*4 Module | 240 | 1/5   |
| 6740 99 | Plastic Surface Box - 9 Module   | 286 | 1/5   |

#### Metal Surface Boxes

|         |  |     |     |
|---------|--|-----|-----|
| 6890 21 | Metal Surface Box - 12 Module (2 Rows*6) | 600 | 1/6 |
| 6890 22 | Metal Surface Box - 18 Module (3 Rows*6) | 634 | 1/4 |

# Lyncus<sup>TM</sup>

Change to today

## Guarantee

- The Company, at its discretion, will replace products if they have any manufacturing defect within 10 years for switches (without LED lamp) and power sockets. For all other **Lyncus<sup>TM</sup>** wiring accessories the guarantee will be 2 years.
- The above guarantee is applicable when the devices are used in Legrand metal flush boxes. Otherwise the guarantee period will be reduced by 50%.
- The guarantee is only applicable when the products are installed as per the Company's instructions and not tampered in any manner.
- The guarantee states the Company's entire liability. It does not extend to cover consequential loss or damage or installation costs arising from defective products.

Our switches are compliant with revised BIS standard (IS 3854:2023 requirements). Also, our switches are covered additionally for use on Self-Ballasted Lamp (SBL) loads.

### SBL power rating as per IS3854:2023

| Switch Rating    | 6A, 230V~ | 10A, 230V~ | 16A, 230V~ | 20A, 230V~ |
|------------------|-----------|------------|------------|------------|
| SBL power (Watt) | 100 W     | 100 W      | 200 W      | 250 W      |

# Allzy™

## The All-Rounder Switch Range



Allzy™ is a versatile modular switch range designed for modern Indian homes and workplaces. Combining stylish finishes, versatile modules, and dependable performance, it delivers convenient solutions for power, charging, connectivity, and everyday control.

### Features

- Durable switch mechanisms tested for 1 lakh on/off operations
- Comprehensive switch range upto 32A rating with low-noise rockers, regulators and dimmers
- 6A, 6/16A sockets shuttered also offering complete USB charging needs for everyday usage
- Connectivity modules RJ11, RJ45, HDMI, AV and projector sockets
- Convenience & hospitality controls such as remote control units, switches, and MMR modules

### Benefits

- Enhances interiors with five stylish plate finishes and dual mechanism colours
- Ensures dependable safety with shuttered sockets, certified components, and durable performance testing
- Enables seamless connectivity for communication, entertainment, and presentations
- Improves convenience through rapid USB charging solutions



## Colour Plates:



Scan to know more about the product.



# Allzy

The All-rounder Switch

Live the Advantage  
of an All-Rounder.

## Range

### SWITCHES



6A Switch 1W-  
Light Marking



6A Switch 1W-  
Fan Marking



20A DP Switch 1W-  
Indicator Marking



6A Bell Push 1W-  
Indicator Marking



Gold- Plate & Frame



Aluminium Champagne-  
Plate & Frame



Rose Gold-Plate & Frame



White-Plate & Frame



Matt Black-Plate & Frame

### SOCKETS

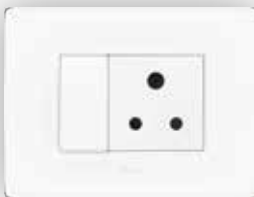

6A 3 Pin Socket with Shutter  
- ISI Mark

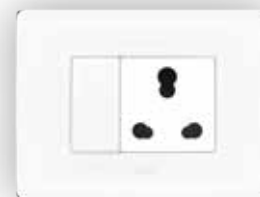

6/16A Socket with shutter  
- ISI Mark

### ELECTRONICS



Fan Regulator 8 step 100W  
- ISI Mark



Fan Regulator 360° 100W  
- ISI Mark



Rotary Dimmer 500W



Remote Control Unit

## USB



Type A + C  
3A, 1M

Type A + C 3A, 2M

Type C 20W PD, 1M

Type C + C 30W PD,  
2M

Type C 45W PD, 2M\*

Type C + C 65W PD, 3M\*

\*45 & 65W COMPATIBLE FOR LAPTOP CHARGING

## VOICE & DATA COMMUNICATIONS



Double RJ11 Telephone  
Socket (with Shutter)

RJ11 Telephone Socket  
(with Shutter)

RJ45 Cat6 UTP Socket  
(with Shutter)

## AUDIO VIDEO CONNECTOR



Preterminated  
Audio Video Connector

Preterminated  
HDMI Socket

## PROTECTION



Power Unit with 20A MCB &  
16A Plug

32A Modular MCB DP

16A Motor starter

## HOSPITALITY



Key card 15A switch-  
Card 230V

32A DP Key tag switch  
(Mechanical)

Shaver Socket 120/230V  
AC with plate

DND & MMR indicator-  
6A bell push (Outside)

DND & MMR (Inside)

**White - Mechanism**

| Cat.Nos | Description | MRP*<br>₹ / Unit | Pack |
|---------|-------------|------------------|------|
|---------|-------------|------------------|------|

**Switches 6A - 230V AC**

|         |  |     |        |
|---------|--|-----|--------|
| 6811 00 | 6A - Switch - SP - 1 Way - 1 Module                        | 54  | 20/400 |
| 6811 11 | 6A - Switch - SP - 2 Way - 1 Module                        | 122 | 20/200 |
| 6811 02 | 6A - Switch - SP - 1 Way - with Indicator - 1 Module       | 108 | 20/200 |
| 6811 03 | 6A - Switch - SP - 1 Way - with "Light" Marking - 1 Module | 110 | 20/200 |
| 6811 04 | 6A - Switch - SP - 1 Way - with "Fan" Marking - 1 Module   | 110 | 20/200 |

**Switches - 10A - 230V AC**

|         |  |     |        |
|---------|--|-----|--------|
| 6811 74 | 10A - Switch - 1 Way - 1 Module                  | 58  | 20/200 |
| 6811 75 | 10A - Switch - 2 Way - 1 Module                  | 124 | 20/200 |
| 6811 76 | 10A - Switch - 1 Way - with Indicator - 1 Module | 108 | 20/200 |

**Switches - 16A - 230V AC**

|         |   |     |        |
|---------|---|-----|--------|
| 6811 01 | 16A - Switch - SP - 1 Way - 1 Module                  | 146 | 20/200 |
| 6811 12 | 16A - Switch - SP - 2 Way - 1 Module                  | 212 | 20/200 |
| 6811 05 | 16A - Switch - SP - 1 Way - with Indicator - 1 Module | 190 | 20/200 |

**Switches - 20A - 230V AC**

|         |   |     |        |
|---------|---|-----|--------|
| 6811 07 | 20A - Switch - SP - 1 Way - 1 Module                  | 174 | 20/200 |
| 6811 08 | 20A - Switch - SP - 1 Way - with Indicator - 1 Module | 230 | 20/200 |
| 6811 13 | 20A - Switch - SP - 1 Way - with Indicator - 2 Module | 262 | 10/100 |
| 6811 15 | 20A - Switch - DP - 1 Way - with Indicator - 2 Module | 268 | 10/100 |

**Switches - 25A - 230V AC**

|         |   |     |        |
|---------|---|-----|--------|
| 6811 06 | 25A - Switch - SP - 1 Way - with Indicator - 1 Module | 244 | 20/200 |
|---------|---|-----|--------|

**Switches - 32A - 230V AC**

|         |   |     |        |
|---------|---|-----|--------|
| 6811 16 | 32A - Switch - DP - 1 Way - with Indicator - 2 Module | 356 | 10/100 |
|---------|---|-----|--------|

**Push Button - 6A - 230V AC**

|         |   |     |        |
|---------|---|-----|--------|
| 6811 09 | 6A - Bell Push - SP - 1 Way - 1 Module                  | 120 | 20/200 |
| 6811 10 | 6A - Bell Push - SP - 1 Way - with Indicator - 1 Module | 146 | 20/200 |
| 6811 14 | 6A - Bell Push - SP - 1 Way - with Indicator - 2 Module | 222 | 10/100 |

**Accessory for Switch with Indicator**

|         |                                |    |        |
|---------|--------------------------------|----|--------|
| 6811 37 | LED Indicator for Switch (Red) | 50 | 1/5/50 |
|---------|--------------------------------|----|--------|

**Indian Standard Sockets**

|         |   |     |        |
|---------|---|-----|--------|
| 6811 24 | 6A - Socket - with Shutter - 3 Pin - ISI - 2 Module | 188 | 20/200 |
| 6811 22 | 6/16A - Socket - with Shutter - ISI - 2 Module      | 270 | 10/100 |

\* MRP - Maximum Retail Price Inclusive of all taxes including GST.  
 ^Compatible with Atomberg (Efficio), Havells (Efficiencia neo), Orient (Aerostorm) as per 2023 fan models.

**White - Mechanism**

| Cat.Nos | Description | MRP*<br>₹ / Unit | Pack |
|---------|-------------|------------------|------|
|---------|-------------|------------------|------|

**Dimmers & Fan Regulators**

|         |   |     |          |
|---------|---|-----|----------|
| 6811 43 | Rotary Dimmer - 400 Watts - 1 Module                            | 578 | 5/50     |
| 6811 44 | Rotary Dimmer - 500 Watts - 2 Module                            | 752 | 10/100   |
| 6811 40 | Fan Regulator - 4 Step - 100 Watts - ISI - 1 Module             | 570 | 5/50     |
| 6811 41 | Fan Regulator - 100 Watts - with 360° Rotation - ISI - 2 Module | 658 | 10/100   |
| 6811 42 | Fan Regulator - 8 Step - 100 Watts - ISI - 2 Module             | 718 | 1/10/100 |
| 6811 99 | Fan Regulator - BLDC - 2 Module^                                | 670 | 1/10/100 |

**Skirting Light**

|         |                           |     |       |
|---------|---------------------------|-----|-------|
| 6811 50 | Skirting Light - 2 Module | 470 | 10/50 |
|---------|---------------------------|-----|-------|

**Indicator**

|         |                               |     |        |
|---------|-------------------------------|-----|--------|
| 6811 38 | Flat Indicator Red - 1 Module | 190 | 20/200 |
|---------|-------------------------------|-----|--------|

**Bell Call Indicator**

|         |                                |     |        |
|---------|--------------------------------|-----|--------|
| 6811 46 | Bell Call Indicator - 1 Module | 816 | 20/200 |
|---------|--------------------------------|-----|--------|

**Buzzer**

|         |                          |     |        |
|---------|--------------------------|-----|--------|
| 6811 39 | Buzzer - 230V - 1 Module | 364 | 20/200 |
|---------|--------------------------|-----|--------|

**Remote Unit**

|         |  |      |        |
|---------|--|------|--------|
| 6811 54 | Remote Control Unit - for Light & Fan - 4 Module | 5126 | 1/5/20 |
|---------|--|------|--------|

**Hospitality Function**
**Hotel Keycard Switch**

|         |   |      |        |
|---------|---|------|--------|
| 6811 17 | 32A - DP - Key Tag Switch (Mechanical) - 2 Module | 594  | 1/10   |
| 6811 79 | Keytag for (681117) WH                            | 276  | 10/100 |
| 6811 47 | 15A - Key Card Switch with Key Fob - Monoblock    | 2864 | 1/10   |

**Hotel "DND and MMR" Functions**

|         |   |     |        |
|---------|---|-----|--------|
| 6811 48 | Internal DND & MMR Control Unit - 2 Module                  | 370 | 10/100 |
| 6811 49 | External DND & MMR Control Unit - with Bell Push - 2 Module | 436 | 10/100 |

**Shaver Socket**

|         |   |      |        |
|---------|---|------|--------|
| 6811 55 | Shaver Socket - 120V/230V - with Plate - 4 Module | 5384 | 1/5/20 |
|---------|---|------|--------|

**Tv Sockets**

|         |                                 |     |        |
|---------|---------------------------------|-----|--------|
| 6811 33 | TV Co - axial Socket - 1 Module | 134 | 20/200 |
|---------|---------------------------------|-----|--------|

**Data & Voice**

|         |   |     |        |
|---------|---|-----|--------|
| 6811 30 | Telephone Socket - RJ11 - with Shutter - 1 Module                 | 140 | 20/200 |
| 6811 31 | Telephone Socket - Double RJ11 - with Shutter - 1 Module          | 212 | 20/200 |
| 6811 32 | Information Socket - RJ45 - Cat 6 - UTP - with Shutter - 1 Module | 729 | 20/200 |

**Audio Video Connectors**

|         |  |      |      |
|---------|--|------|------|
| 6811 34 | Preterminated HDMI Socket - 1 Module           | 1380 | 1/10 |
| 6811 35 | Preterminated Audio/Video Connector - 1 Module | 1376 | 1/10 |
| 6811 36 | Preterminated Projector Connector - 1 Module   | 1791 | 1/10 |

**Sound (Electronic Bell)**

|         |                            |     |        |
|---------|----------------------------|-----|--------|
| 6811 45 | Electronic Bell - 2 Module | 408 | 10/100 |
|---------|----------------------------|-----|--------|

**Protectors and Accessories**
**Motor Starter**

|         |                                |     |          |
|---------|--------------------------------|-----|----------|
| 6811 66 | 16A - Motor Starter - 2 Module | 666 | 1/10/100 |
| 6811 67 | 25A - Motor Starter - 2 Module | 666 | 1/10/100 |

Bold Cat.Nos are products normally available with Legrand (India) Stockists. Cat.Nos that are not bold - delivery within 4 - 8 weeks from the date of order. Bold packing quantity is our mandatory packing. Orders to be placed by Legrand (India) Stockist in multiples of the same.

**White - Mechanism**

| Cat.Nos | Description | MRP*<br>₹ / Unit | Pack |
|---------|-------------|------------------|------|
|---------|-------------|------------------|------|

**Modular MCB (IS : 608981:2002)**

|         |                                   |     |          |
|---------|-----------------------------------|-----|----------|
| 6811 56 | 6A - Modular MCB - SP - 1 Module  | 502 | 1/10/100 |
| 6811 57 | 10A - Modular MCB - SP - 1 Module | 502 | 1/10/100 |
| 6811 58 | 16A - Modular MCB - SP - 1 Module | 502 | 1/10/100 |
| 6811 59 | 20A - Modular MCB - SP - 1 Module | 502 | 1/10/100 |
| 6811 60 | 25A - Modular MCB - SP - 1 Module | 502 | 1/10/100 |
| 6811 61 | 32A - Modular MCB - SP - 1 Module | 502 | 1/10/100 |
| 6811 62 | 16A - Modular MCB - DP - 2 Module | 954 | 1/10/100 |
| 6811 63 | 20A - Modular MCB - DP - 2 Module | 954 | 1/10/100 |
| 6811 64 | 25A - Modular MCB - DP - 2 Module | 954 | 1/10/100 |
| 6811 65 | 32A - Modular MCB - DP - 2 Module | 954 | 1/10/100 |

**Power Unit**

|         |  |      |      |
|---------|--|------|------|
| 6811 27 | Power Unit with 20A SP MCB & 16A Plug - 3 Module | 1484 | 1/10 |
| 6811 28 | Power Unit with 25A SP MCB & 16A Plug - 3 Module | 1588 | 1/10 |

**Electronic Function**
**USB Chargers (IS13252 (Part 1) / IEC 60950-1)**

|                     |   |      |        |
|---------------------|---|------|--------|
| 6811 52             | USB Charger - 1500mA - Type A - 1 Module                        | 1116 | 10/100 |
| 6811 51             | USB Charger - 3000mA - Type A+ A - 2 Module                     | 1782 | 10/100 |
| 6811 70             | USB Charger - 3000mA - Type A + C - 2 Module                    | 2164 | 10/100 |
| 6811 80             | USB Charger - 3000mA/15 Watts - Type A - 1 Module               | 1740 | 1/5/50 |
| 6811 81             | USB Charger - 3000mA/15 Watts - Type A + A - 1 Module           | 1918 | 1/5/50 |
| 6811 82             | USB Charger - 3000mA/15 Watts - Type A + C - 1 Module           | 2446 | 1/5/50 |
| 6811 83             | USB Charger - 3000mA/15 Watts - Type C + C - 1 Module           | 2670 | 1/5/50 |
| 6811 84             | USB Charger - Power Delivery - 20 Watts - Type C - 1 Module     | 3244 | 1/5/50 |
| 6811 85             | USB Charger - Power Delivery - 30 Watts - Type C + C - 2 Module | 6158 | 1/3/30 |
| 6811 86             | USB Charger - Power Delivery - 45 Watts - Type C - 2 Module     | 7756 | 1/3/30 |
| <b>NEW!</b> 6811 96 | USB Charger - Power Delivery - 65 Watts - Type C + C - 3 Module | 9824 | 1/5/20 |

**Accessories**

|         |                               |     |        |
|---------|-------------------------------|-----|--------|
| 6811 68 | Cable Outlet - 8MM - 1 Module | 112 | 20/200 |
| 6811 69 | Blanking Plate - 1 Module     | 34  | 40/400 |

**Matt Black Mechanism**
**Switches 6A - 230 V AC**

|         |  |     |        |
|---------|--|-----|--------|
| 6812 00 | 6A - Switch - SP - 1 Way - 1 Module                        | 58  | 20/400 |
| 6812 11 | 6A - Switch - SP - 2 Way - 1 Module                        | 138 | 20/200 |
| 6812 02 | 6A - Switch - SP - 1 Way - with Indicator - 1 Module       | 118 | 20/200 |
| 6812 03 | 6A - Switch - SP - 1 Way - with "Light" Marking - 1 Module | 124 | 20/200 |
| 6812 04 | 6A - Switch - SP - 1 Way - with "Fan" Marking - 1 Module   | 124 | 20/200 |

**Matt Black - Mechanism**

| Cat.Nos | Description | MRP*<br>₹ / Unit | Pack |
|---------|-------------|------------------|------|
|---------|-------------|------------------|------|

**Switches 16A - 230 V AC**

|         |   |     |        |
|---------|---|-----|--------|
| 6812 01 | 16A - Switch - SP - 1 Way - 1 Module                  | 166 | 20/200 |
| 6812 12 | 16A - Switch - SP - 2 Way - 1 Module                  | 242 | 20/200 |
| 6812 05 | 16A - Switch - SP - 1 Way - with Indicator - 1 Module | 220 | 20/200 |

**Switches 20A - 230V AC**

|         |   |     |        |
|---------|---|-----|--------|
| 6812 07 | 20A - Switch - SP - 1 Way - 1 Module                  | 204 | 20/200 |
| 6812 08 | 20A - Switch - SP - 1 Way - with Indicator - 1 Module | 268 | 20/200 |
| 6812 13 | 20A - Switch - SP - 1 Way - with Indicator - 2 Module | 300 | 10/100 |
| 6812 15 | 20A - Switch - DP - 1 Way - with Indicator - 2 Module | 300 | 10/100 |

**Switches 25A - 230 V AC**

|         |   |     |        |
|---------|---|-----|--------|
| 6812 06 | 25A - Switch - SP - 1 Way - with Indicator - 1 Module | 276 | 20/200 |
|---------|---|-----|--------|

**Switches 32A - 230 V AC**

|         |   |     |        |
|---------|---|-----|--------|
| 6812 16 | 32A - Switch - DP - 1 Way - with Indicator - 2 Module | 410 | 10/100 |
|---------|---|-----|--------|

**Push Button 6A - 230 V AC**

|         |   |     |        |
|---------|---|-----|--------|
| 6812 09 | 6A - Bell Push - SP - 1 Way - 1 Module                  | 136 | 20/200 |
| 6812 10 | 6A - Bell Push - SP - 1 Way - with Indicator - 1 Module | 166 | 20/200 |
| 6812 14 | 6A - Bell Push - SP - 1 Way - with Indicator - 2 Module | 256 | 10/100 |

**Indian Standard Sockets**

|         |   |     |        |
|---------|---|-----|--------|
| 6812 24 | 6A - Socket - with Shutter - 3 Pin - ISI - 2 Module | 226 | 20/200 |
| 6812 22 | 6/16A - Socket - with Shutter - ISI - 2 Module      | 306 | 10/100 |

**Dimmers & Fan Regulators**

|         |   |     |          |
|---------|---|-----|----------|
| 6812 43 | Rotary Dimmer - 400 Watts - 1 Module                            | 662 | 5/50     |
| 6812 44 | Rotary Dimmer - 500 Watts - 2 Module                            | 858 | 10/100   |
| 6812 40 | Fan Regulator - 4 Step - 100 Watts - ISI - 1 Module             | 660 | 5/50     |
| 6812 41 | Fan Regulator - 100 Watts - with 360° Rotation - ISI - 2 Module | 750 | 10/100   |
| 6812 42 | Fan Regulator - 8 Step - 100 Watts - ISI - 2 Module             | 848 | 1/10/100 |
| 6812 99 | Fan Regulator - BLDC - 2 Module^                                | 764 | 10/100   |

**Skirting Light**

|         |                           |     |         |
|---------|---------------------------|-----|---------|
| 6812 50 | Skirting Light - 2 Module | 536 | 1/10/50 |
|---------|---------------------------|-----|---------|

**Indicator**

|         |                               |     |        |
|---------|-------------------------------|-----|--------|
| 6812 38 | Flat Indicator Red - 1 Module | 210 | 20/200 |
|---------|-------------------------------|-----|--------|

**Buzzer**

|         |                          |     |        |
|---------|--------------------------|-----|--------|
| 6812 39 | Buzzer - 230V - 1 Module | 414 | 20/200 |
|---------|--------------------------|-----|--------|

**Remote Unit**

|         |  |      |        |
|---------|--|------|--------|
| 6812 54 | Remote Control Unit - for Light & Fan - 4 Module | 5440 | 1/5/20 |
|---------|--|------|--------|

**Hospitality Function**
**Hotel Keycard Switch**

|         |   |      |        |
|---------|---|------|--------|
| 6812 17 | 32A - DP - Key Tag Switch (Mechanical) - 2 Module | 676  | 1/10   |
| 6812 79 | Keytag for (681217) MB                            | 310  | 10/100 |
| 6812 47 | 15A - Key Card Switch with Key Fob - Monoblock    | 3598 | 1/10   |

**Hotel "DND and MMR" Functions**

|         |   |     |        |
|---------|---|-----|--------|
| 6812 48 | Internal DND & MMR Control Unit - 2 Module                  | 456 | 10/100 |
| 6812 49 | External DND & CMR Control Unit - with Bell Push - 2 Module | 516 | 10/100 |

\* MRP - Maximum Retail Price Inclusive of all taxes including GST.

^Compatible with Atomberg (Efficio), Havells (Efficiencia neo), Orient (Aerostorm) as per 2023 fan models.

Red Cat.Nos - new products

Bold Cat.Nos are products normally available with Legrand (India) Stockists. Cat.Nos that are not bold - delivery within 4 - 8 weeks from the date of order. Bold packing quantity is our mandatory packing. Orders to be placed by Legrand (India) Stockist in multiples of the same.

## Allzy™ Matt Black - Mechanism

| Cat.Nos | Description | MRP*<br>₹ / Unit | Pack |
|---------|-------------|------------------|------|
|---------|-------------|------------------|------|

### Shaver Socket

|         |   |      |        |
|---------|---|------|--------|
| 6812 55 | Shaver Socket - 120V/230V - with Plate - 4 Module | 6140 | 1/5/20 |
|---------|---|------|--------|

### Tv Sockets

|         |                                 |     |        |
|---------|---------------------------------|-----|--------|
| 6812 33 | TV Co - axial Socket - 1 Module | 154 | 20/200 |
|---------|---------------------------------|-----|--------|

### Data & Voice

|         |   |     |        |
|---------|---|-----|--------|
| 6812 30 | Telephone Socket - RJ11 - with Shutter - 1 Module                 | 166 | 20/200 |
| 6812 31 | Telephone Socket - Double RJ11 - with Shutter - 1 Module          | 236 | 20/200 |
| 6812 32 | Information Socket - RJ45 - Cat 6 - UTP - with Shutter - 1 Module | 857 | 20/200 |

### Audio Video Connectors

|         |  |      |      |
|---------|--|------|------|
| 6812 34 | Preterminated HDMI Socket - 1 Module           | 1571 | 1/10 |
| 6812 35 | Preterminated Audio/Video Connector - 1 Module | 1570 | 1/10 |
| 6812 36 | Preterminated Projector Connector - 1 Module   | 2040 | 1/10 |

### Protectors & Accessories

#### Motor Starter

|         |                                |     |          |
|---------|--------------------------------|-----|----------|
| 6812 66 | 16A - Motor Starter - 2 Module | 766 | 1/10/100 |
| 6812 67 | 25A - Motor Starter - 2 Module | 766 | 1/10/100 |

#### Modular MCB (IS : 608981:2002)

|         |                                   |     |          |
|---------|-----------------------------------|-----|----------|
| 6812 56 | 6A - Modular MCB - SP - 1 Module  | 572 | 1/10/100 |
| 6812 57 | 10A - Modular MCB - SP - 1 Module | 572 | 1/10/100 |
| 6812 58 | 16A - Modular MCB - SP - 1 Module | 572 | 1/10/100 |
| 6812 59 | 20A - Modular MCB - SP - 1 Module | 572 | 1/10/100 |
| 6812 60 | 25A - Modular MCB - SP - 1 Module | 572 | 1/10/100 |
| 6812 61 | 32A - Modular MCB - SP - 1 Module | 572 | 1/10/100 |

### Power Unit

|         |  |      |      |
|---------|--|------|------|
| 6812 27 | Power Unit with 20A SP MCB & 16A Plug - 3 Module | 1688 | 1/10 |
| 6812 28 | Power Unit with 25A SP MCB & 16A Plug - 3 Module | 1812 | 1/10 |

### Electronic Function

#### USB Chargers (IS13252 (Part 1) / IEC 60950-1)

|                     |   |       |        |
|---------------------|---|-------|--------|
| 6812 52             | USB Charger - 1500mA - Type A - 1 Module                        | 1402  | 10/100 |
| 6812 51             | USB Charger - 3000mA - Type A + A - 2 Module                    | 2072  | 10/100 |
| 6812 70             | USB Charger - 3000mA - Type A + C - 2 Module                    | 2470  | 10/100 |
| 6812 80             | USB Charger - 3000mA/15 Watts - Type A - 1 Module               | 1918  | 1/5/50 |
| 6812 81             | USB Charger - 3000mA/15 Watts - Type A + A - 1 Module           | 2124  | 1/5/50 |
| 6812 82             | USB Charger - 3000mA/15 Watts - Type A + C - 1 Module           | 2644  | 1/5/50 |
| 6812 83             | USB Charger - 3000mA/15 Watts - Type C + C - 1 Module           | 2892  | 1/5/50 |
| 6812 84             | USB Charger - Power Delivery - 20 Watts - Type C - 1 Module     | 3656  | 1/5/50 |
| 6812 85             | USB Charger - Power Delivery - 30 Watts - Type C + C - 2 Module | 6630  | 1/3/30 |
| 6812 86             | USB Charger - Power Delivery - 45 Watts - Type C - 2 Module     | 8552  | 1/3/30 |
| <b>NEW!</b> 6812 96 | USB Charger - Power Delivery - 65 Watts - Type C + C - 3 Module | 10474 | 1/5/20 |

\* MRP - Maximum Retail Price Inclusive of all taxes including GST.  
Red Cat. Nos - New Products

## Allzy™ Matt Black - Mechanism

| Cat.Nos | Description | MRP*<br>₹ / Unit | Pack |
|---------|-------------|------------------|------|
|---------|-------------|------------------|------|

### Accessories

|         |                               |     |        |
|---------|-------------------------------|-----|--------|
| 6812 68 | Cable Outlet - 8MM - 1 Module | 128 | 20/200 |
| 6812 69 | Blanking Plate - 1 Module     | 40  | 40/400 |

### Cover Plates with Support Frame White Cover Plates with Support Frame

|         |   |     |        |
|---------|---|-----|--------|
| 6813 00 | Cover Plate + Frame - 1 Module - White            | 144 | 20/200 |
| 6813 01 | Cover Plate + Frame - 2 Module - White            | 144 | 20/200 |
| 6813 02 | Cover Plate + Frame - 3 Module - White            | 204 | 10/100 |
| 6813 03 | Cover Plate + Frame - 4 Module - White            | 216 | 10/100 |
| 6813 04 | Cover Plate + Frame - 6 Module - White            | 296 | 5/50   |
| 6813 05 | Cover Plate + Frame - 8 Module - Horizontal-White | 362 | 5/50   |
| 6813 06 | Cover Plate + Frame - 2*4 Module - Vertical-White | 362 | 5/25   |
| 6813 07 | Cover Plate + Frame - 9 Module - White            | 420 | 5/50   |
| 6813 08 | Cover Plate + Frame - 12 Module - White           | 520 | 10     |
| 6813 09 | Cover Plate + Frame - 16 Module - White           | 556 | 10     |
| 6813 10 | Cover Plate + Frame - 18 Module - White           | 594 | 10     |

### Matt Black Cover Plates With Support Frame

|         |   |     |        |
|---------|---|-----|--------|
| 6813 11 | Cover Plate with Frame - 1 Module - Matt Black            | 184 | 20/200 |
| 6813 12 | Cover Plate with Frame - 2 Module - Matt Black            | 184 | 20/200 |
| 6813 13 | Cover Plate with Frame - 3 Module - Matt Black            | 242 | 10/100 |
| 6813 14 | Cover Plate with Frame - 4 Module - Matt Black            | 278 | 10/100 |
| 6813 15 | Cover Plate with Frame - 6 Module - Matt Black            | 378 | 5/50   |
| 6813 16 | Cover Plate with Frame - 8 Module - Horizontal-Matt Black | 416 | 5/50   |
| 6813 17 | Cover Plate with Frame - 2*4 Module - Vertical-Matt Black | 416 | 5/25   |
| 6813 18 | Cover Plate with Frame - 9 Module - Matt Black            | 502 | 5/50   |
| 6813 19 | Cover Plate with Frame - 12 Module - Matt Black           | 606 | 10     |
| 6813 20 | Cover Plate with Frame - 16 Module - Matt Black           | 690 | 10     |
| 6813 21 | Cover Plate with Frame - 18 Module - Matt Black           | 734 | 10     |

### Gold Cover Plates with Support Frame

|         |   |     |        |
|---------|---|-----|--------|
| 6813 33 | Cover Plate with Frame - 1 Module - Gold            | 194 | 20/200 |
| 6813 34 | Cover Plate with Frame - 2 Module - Gold            | 194 | 20/200 |
| 6813 35 | Cover Plate with Frame - 3 Module - Gold            | 262 | 10/100 |
| 6813 36 | Cover Plate with Frame - 4 Module - Gold            | 284 | 10/100 |
| 6813 37 | Cover Plate with Frame - 6 Module - Gold            | 420 | 5/50   |
| 6813 38 | Cover Plate with Frame - 8 Module - Horizontal-Gold | 468 | 5/50   |
| 6813 39 | Cover Plate with Frame - 2*4 Module - Vertical-Gold | 468 | 5/25   |
| 6813 40 | Cover Plate with Frame - 9 Module - Gold            | 562 | 5/50   |
| 6813 41 | Cover Plate with Frame - 12 Module - Gold           | 676 | 10     |
| 6813 42 | Cover Plate with Frame - 16 Module - Gold           | 734 | 10     |
| 6813 43 | Cover Plate with Frame - 18 Module - Gold           | 778 | 10     |

Bold Cat.Nos are products normally available with Legrand (India) Stockists. Cat.Nos that are not bold - delivery within 4 - 8 weeks from the date of order. Bold packing quantity is our mandatory packing. Orders to be placed by Legrand (India) Stockist in multiples of the same.

**Allzy™**
**Cover Plates**

| Cat.Nos | Description | MRP*<br>₹ / Unit | Pack |
|---------|-------------|------------------|------|
|---------|-------------|------------------|------|

**Aluminium Champagne Cover Plates with Support Frame**

|         |   |     |        |
|---------|---|-----|--------|
| 6813 44 | Cover Plate with Frame - 1 Module - Aluminium Champagne             | 194 | 20/200 |
| 6813 45 | Cover Plate with Frame - 2 Module - Aluminium Champagne             | 194 | 20/200 |
| 6813 46 | Cover Plate with Frame - 3 Module - Aluminium Champagne             | 262 | 10/100 |
| 6813 47 | Cover Plate with Frame - 4 Module - Aluminium Champagne             | 284 | 10/100 |
| 6813 48 | Cover Plate with Frame - 6 Module - Aluminium Champagne             | 420 | 5/50   |
| 6813 49 | Cover Plate with Frame - 8 Module - Horizontal- Aluminium Champagne | 468 | 5/50   |
| 6813 50 | Cover Plate with Frame - 2*4 Module - Vertical- Aluminium Champagne | 468 | 5/25   |
| 6813 51 | Cover Plate with Frame - 9 Module - Aluminium Champagne             | 562 | 5/50   |
| 6813 52 | Cover Plate with Frame - 12 Module - Aluminium Champagne            | 676 | 10     |
| 6813 53 | Cover Plate with Frame - 16 Module - Aluminium Champagne            | 734 | 10     |
| 6813 54 | Cover Plate with Frame - 18 Module - Aluminium Champagne            | 778 | 10     |

**Rose Gold Cover Plates with Support Frame**

|         |  |     |        |
|---------|--|-----|--------|
| 6813 55 | Cover Plate with Frame - 1 Module - Rose Gold            | 194 | 20/200 |
| 6813 56 | Cover Plate with Frame - 2 Module - Rose Gold            | 194 | 20/200 |
| 6813 57 | Cover Plate with Frame - 3 Module - Rose Gold            | 262 | 10/100 |
| 6813 58 | Cover Plate with Frame - 4 Module - Rose Gold            | 284 | 10/100 |
| 6813 59 | Cover Plate with Frame - 6 Module - Rose Gold            | 420 | 5/50   |
| 6813 60 | Cover Plate with Frame - 8 Module - Horizontal-Rose Gold | 468 | 5/50   |
| 6813 61 | Cover Plate with Frame - 2*4 Module - Vertical-Rose Gold | 468 | 5/25   |
| 6813 62 | Cover Plate with Frame - 9 Module - Rose Gold            | 562 | 5/50   |
| 6813 63 | Cover Plate with Frame - 12 Module - Rose Gold           | 676 | 10     |
| 6813 64 | Cover Plate with Frame - 16 Module - Rose Gold           | 734 | 10     |
| 6813 65 | Cover Plate with Frame - 18 Module - Rose Gold           | 778 | 10     |

\* MRP - Maximum Retail Price Inclusive of all taxes including GST.

**Allzy™**
**Mounting Boxes**

| Cat.Nos | Description | MRP*<br>₹ / Unit | Pack |
|---------|-------------|------------------|------|
|---------|-------------|------------------|------|

**Accessories**
**Metal Flush Boxes**

|         |  |     |    |
|---------|--|-----|----|
| 6890 60 | Metal Flush Box - 1 & 2 Module         | 88  | 40 |
| 6890 61 | Metal Flush Box - 3 Module             | 116 | 40 |
| 6890 62 | Metal Flush Box - 4 Module             | 140 | 40 |
| 6890 63 | Metal Flush Box - 6 Module             | 222 | 40 |
| 6890 65 | Metal Flush Box - 8 Module             | 278 | 40 |
| 6890 64 | Metal Flush Box - 8 (2 Rows*4) Module  | 278 | 20 |
| 6890 66 | Metal Flush Box - 12 (2 Rows*6) Module | 386 | 10 |
| 6890 67 | Metal Flush Box - 16 (2 Rows*8) Module | 436 | 10 |
| 6890 68 | Metal Flush Box - 18 Module            | 498 | 10 |

**Plastic Surface Boxes**

|         |  |     |    |
|---------|--|-----|----|
| 6890 70 | Plastic Surface Box - 1 & 2 Module         | 70  | 50 |
| 6890 71 | Plastic Surface Box - 3 Module             | 86  | 35 |
| 6890 72 | Plastic Surface Box - 4 Module             | 112 | 25 |
| 6890 73 | Plastic Surface Box - 6 Module             | 168 | 10 |
| 6813 70 | Plastic Surface Box - 8 Module             | 254 | 10 |
| 6890 74 | Plastic Surface Box - 8 (2 Rows*4) Module  | 230 | 10 |
| 6890 76 | Plastic Surface Box - 12 (2 Rows*6) Module | 280 | 10 |
| 6890 77 | Plastic Surface Box - 16 (2 Rows*8) Module | 330 | 10 |

**Metal Surface Box**

|         |                               |     |    |
|---------|-------------------------------|-----|----|
| 6890 78 | Metal Surface Box - 18 Module | 350 | 10 |
|---------|-------------------------------|-----|----|

Our switches are compliant with revised BIS standard (IS 3854:2023 requirements). Also, our switches are covered additionally for use on Self-Ballasted Lamp (SBL) loads.

**SBL power rating as per IS3854:2023**

| Switch Rating    | 6A, 230V~ | 10A, 230V~ | 16A, 230V~ | 20A, 230V~ |
|------------------|-----------|------------|------------|------------|
| SBL power (Watt) | 100 W     | 100 W      | 200 W      | 250 W      |

Bold Cat.Nos are products normally available with Legrand (India) Stockists. Cat.Nos that are not bold - delivery within 4 - 8 weeks from the date of order. Bold packing quantity is our mandatory packing. Orders to be placed by Legrand (India) Stockist in multiples of the same.

# Workstation Power and Data Solutions

## Flexible Power and Data Access for Modern Workspaces

**Legrand Workstation Solutions** provide a complete and integrated approach to power and data distribution for modern office environments. Combining floor boxes, raised and screed floor systems, pop-up desk units, and perimeter trunking, the range is designed to deliver seamless connectivity, organized cable management, and flexible workstation layouts. Engineered for both performance and aesthetics, these solutions ensure easy installation, scalability, and adaptability to evolving workspace needs—making them ideal for dynamic offices, commercial spaces, and collaborative environments.

### Features

- Comprehensive solution for power, AV & data distribution
- Compatible with perimeter, desk, raised access floors and screed floor systems
- Designed for fast installation with high reliability, robustness, and flexibility
- Engineered for strength, supporting superior load capacities for demanding environments

### Benefits

- Ensures organized and efficient power and data distribution across office spaces
- Enables flexible workstation layouts with easily accessible floor and desk outlets
- Improves workspace aesthetics with concealed and flush-mounted installations
- Supports scalable infrastructure for high-density workstation environments and future expansion



Alongside the Incara™ range, Legrand provides additional workspace solutions such as trunking systems, raised floor boxes, metal and aluminium floor outlets, desk grommets, and underfloor distribution to support scalable office infrastructure.



Soluflex cable floor system



Raceways : PVC & Metal (GI)



Floor boxes

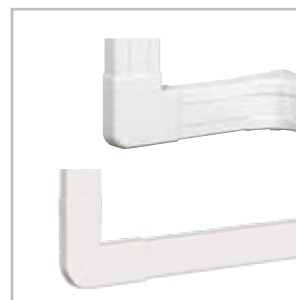

Dlp trunking system:  
Snap-on, Mini & PVC, Aluminium



Cablofil wire mesh cable trays

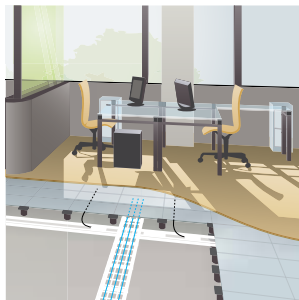

Raised access floor systems



Screed floor system



Wall and ceiling systems

Scan to know more about the product.



**Incara Top Access**



**Disq 80**



**Disq 60**

# INCARA™ Pop-up Box

## Elegant Design with Seamless Connectivity



Incara™ Pop-up provides convenient access to power, data, and charging for laptops, smartphones, tablets, and AV equipment directly at the workspace. Its patented design integrates discreetly into furniture, offering smooth damper operation and premium finishes that blend seamlessly with modern interiors.

### Features

- Extra-slim pop-up design compatible with 15–40 mm desktops
- Multiple module configurations available in 3, 4, 8, and 2x4 formats. Also available 4 module in IP44 option
- Premium finishes including White, Black, Aluminium, and Brushed Aluminium
- Compatible with 250+ Arteor & Advance modules, including USB-C PD up to 63/65W

### Benefits

- Improves workspace efficiency with easy access to power and connectivity
- Maintains a clean desk aesthetic with discreet, flush integration into furniture
- Ensures reliable daily use with robust construction and protection options
- Adapts to evolving technology needs through modular configuration and fast charging support

Now Available with  
Arteor™ Advance Modules



Scan to know more about  
the product.



# INCARA™ Flip-up Box

## Elegant Connectivity for Premium Meeting Rooms



Incara™ Flip-up is a premium tabletop connectivity solution designed for modern meeting rooms. Its fully metal construction and patented push-to-open mechanism allow the unit to rise smoothly while the cover slides discreetly inside even with devices plugged in providing seamless access to power, data, and AV connections.

### Features

- Patented push-to-open flip mechanism with smooth, dual-sided access
- Robust all-metal construction with premium finish
- Quick, tool-free installation for 15–40 mm desktops
- Pre-equipped Arteor modules including sockets, USB-C charging, HDMI, and RJ45

### Benefits

- Enhances meeting room aesthetics with discreet, integrated connectivity
- Improves collaboration through easy access to power and data from both sides
- Reduces installation time with fast and secure mounting design
- Supports modern AV setups with versatile power, data, and charging options



Now Available with  
Arteor™ Advance Modules

Scan to know more about  
the product.



# INCARA™ Top Access

## Discreet Cable Management for Meeting Tables



Incara™ Top Access provides a practical solution for organizing power modules and cables beneath meeting tables. With a flush-mounted lid and integrated storage basket, it keeps worktops clear while allowing easy access to chargers, power strips, and connectivity modules in modern meeting and collaboration spaces.

### Features

- Integrated metal storage basket for power strips and excess cabling
- Two width options: 295 mm and 385 mm for different table sizes
- Premium finishes: White, Black, and Metal to match furniture styles
- Flush-mount lid with soft-close damper for 10–40 mm desktops

### Benefits

- Keeps meeting tables organised by concealing cables and adapters
- Maintains a clean, professional workspace appearance
- Simplifies cable routing with dedicated under-desk storage
- Supports flexible integration with office power and connectivity modules



Scan to know more about the product.



## Incara™ Flip up

| Cat.Nos | Description | MRP*<br>₹ / Unit | Pack |
|---------|-------------|------------------|------|
|---------|-------------|------------------|------|

Max. power: 3680 W at 230 VA  
 6A switch d IS 3854 : 1997  
 6A sockets IS 1293: 2019  
 USB IEC 60950 1  
 IS 13252(Part 1)  
 Protection IK 07 & IP 30  
 For flush mounting in furniture,  
 Compatible for desk thickness 15 to 40  
**Incara™ Flip up Pre Equipped (Arteor Advance)**

|         |  |       |   |
|---------|--|-------|---|
| 6540 24 | Flip-up 8M SW 2 SKT USB C+C 1 HDMI         | 37480 | 1 |
| 6540 25 | Flip-up 8M SW 2 SKT USB C+C 1 RJ45 1 HDMI  | 38376 | 1 |
| 6540 26 | Flip-up 12M SW 4 SKT USB C+C 1 HDMI        | 41476 | 1 |
| 6540 27 | Flip-up 12M SW 4 SKT USB C+C 1 RJ45 1 HDMI | 42338 | 1 |

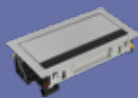

6540 24

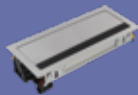

6540 27

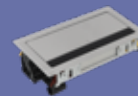

6540 22



6540 23

### INCARA Flip Up (Empty)

To be equipped version of the Incara Flip up is compatible with Arteor Advance accessories, which need to be purchased separately.

|         |                                    |       |   |
|---------|------------------------------------|-------|---|
| 6540 22 | Flip-up 8M To Be Equipped Version  | 32181 | 1 |
| 6540 23 | Flip-up 12M To Be Equipped Version | 34437 | 1 |

### INCARA Top Access (Empty)

Easy storage for an office module, Desktop Power Center, Legrand UI with Surface Box DLP with accessories or equivalent product that can accommodate chargers and wires.

Resistance to impacts: IK 07  
 Operating temperature: from 5°C to +35°C

**For Flush Mounting In Furniture, Compatible Table Thickness 10 To 40**

|         |                                 |       |   |
|---------|---------------------------------|-------|---|
| 6548 70 | Top Access 295MM Wide Aluminium | 11033 | 1 |
| 6548 71 | Top Access 295MM Wide White     | 12851 | 1 |
| 6548 72 | Top Access 295MM Wide Black     | 12332 | 1 |
| 6548 73 | Top Access 395MM Wide Aluminium | 14667 | 1 |
| 6548 74 | Top Access 395MM Wide White     | 16420 | 1 |
| 6548 75 | Top Access 395MM Wide Black     | 15706 | 1 |

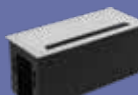

6548 70

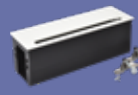

6548 73



6548 75

## INCARA Pop Up (Empty)

| Cat.Nos | Description | MRP*<br>₹ / Unit | Pack |
|---------|-------------|------------------|------|
|---------|-------------|------------------|------|

Resistance to Impact: IK 07  
 IP 44 for 6 548 12 & IP 20 for the others  
 Operating temperature: from 5°C to +35°C  
 Conform to standard BS 5733  
 Compatible with Arteor accessories, which need to be purchased separately.  
 Switch d IS 3854 : 1997  
 Sockets IS 1293: 2019  
 USB IEC 60950 1  
 Switch lasts 100000 & Socket for 10000 plug ins  
 Fire resistant up to 850°C for 30 seconds.

**For Flush Mounting In Furniture, Compatible Desktop Thickness 15 to 40.**

|         |                                   |       |   |
|---------|-----------------------------------|-------|---|
| 6548 45 | Pop-up 3M Brushed Aluminium       | 4568  | 1 |
| 6548 46 | Pop-up 3M White                   | 3714  | 1 |
| 6548 47 | Pop-up 3M Black                   | 3714  | 1 |
| 6548 48 | Pop-up 3M Aluminium               | 3714  | 1 |
| 6548 00 | Pop-up 4M Brushed Aluminium       | 5740  | 1 |
| 6548 01 | Pop-up 4M White                   | 5219  | 1 |
| 6548 02 | Pop-up 4M Black                   | 5219  | 1 |
| 6548 03 | Pop-up 4M Aluminium               | 5219  | 1 |
| 6548 12 | IP 44 Pop-up 4M Brushed Aluminium | 8944  | 1 |
| 6548 08 | Pop-up 8M Brushed Aluminium       | 11673 | 1 |
| 6548 09 | Pop-up 8M White                   | 10613 | 1 |
| 6548 10 | Pop-up 8M Black                   | 10613 | 1 |
| 6548 11 | Pop-up 8M Aluminium               | 10613 | 1 |
| 6548 04 | Pop-up 2x4M Brushed Al            | 12257 | 1 |
| 6548 05 | Pop-up 2x4M Wh                    | 11143 | 1 |
| 6548 06 | Pop-up 2x4M Black                 | 11143 | 1 |
| 6548 07 | Pop-up 2x4M Al                    | 11143 | 1 |



6548 46



6548 48



6548 00



6548 01



6548 03



6548 10

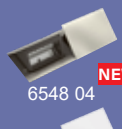

6548 04

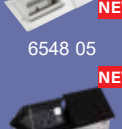

6548 05



6548 06

\* MRP - Maximum Retail Price Inclusive of all taxes including GST.  
 Red Cat.Nos - new products

Bold Cat.Nos are products normally available with Legrand (India) Stockists.  
 Cat.Nos that are not bold - delivery within 4 - 8 weeks from the date of order.  
 Bold packing quantity is our mandatory packing. Orders to be placed by Legrand (India) Stockist in multiples of the same.

**NEW!**

# Desktop Power Center

## Practical Power for Modern Workspaces



Desktop Power Center (DPC) brings power and connectivity right to your fingertips. Designed for modern workspaces, it delivers seamless access to power, charging, AV, and data—while keeping desks clean, organized, and clutter-free. Fully customizable with power sockets, USB chargers, and connectivity modules, DPC adapts effortlessly to your workspace needs with style and efficiency

### Features

- Modular 6M and 8M configurations with 3-pin 6A sockets and optional USB charging
- Flexible mounting options for on-desk, under-desk, or wall installation
- Child-safe IP20 sockets tested for up to 10,000 plug cycles
- IS-certified switch socket design with maximum load capacity up to 1440 W

### Benefits

- Provides convenient power access directly at the workspace
- Keeps desks organised by reducing cable clutter
- Enhances user safety with child-protected outlets
- Simplifies installation with versatile mounting options



Scan to know more about the product.



## Desktop Power Center

| Cat.Nos | Description | MRP*<br>₹ / Unit | Pack |
|---------|-------------|------------------|------|
|---------|-------------|------------------|------|

Switch IS 3854 : 1997  
Sockets IS 1293: 2019  
USB IEC 60950 1  
Switch lasts 100000 & Socket for 10000 plug ins  
Fire resistant up to 850°C for 30 seconds.  
Input : 100 240V 50 60Hz/250 mA  
Output 5V 1500mA  
Power rating 1440W Max  
3 PIN Socket 6A 230V IP 20 Rated

### Desktop Power Center supplied With L Bracket Kit

1.5 meter cord and a 3 pin plug for easy connection to power

|         |                     |      |   |
|---------|---------------------|------|---|
| 6550 20 | 6M DPC SKT White    | 1348 | 1 |
| 6550 22 | 8M DPC SKT White    | 1753 | 1 |
| 6550 24 | 6M DPC SKT ChicGrey | 1660 | 1 |
| 6550 26 | 8M DPC SKT ChicGrey | 2092 | 1 |

### Desktop Power Center with USB Type A

|         |                           |      |   |
|---------|---------------------------|------|---|
| 6550 21 | 6M DPC SKT USB A White    | 2159 | 1 |
| 6550 23 | 8M DPC SKT USB A White    | 2966 | 1 |
| 6550 25 | 6M DPC SKT USB A ChicGrey | 2495 | 1 |
| 6550 27 | 8M DPC SKT USB A ChicGrey | 3412 | 1 |

### Desktop Power Center with USB Type A + C Ports

|           |                             |      |   |
|-----------|-----------------------------|------|---|
| 6550 21AC | 6M DPC SKT USB A+C White    | 3647 | 1 |
| 6550 23AC | 8M DPC SKT USB A+C White    | 3861 | 1 |
| 6550 25AC | 6M DPC SKT USB A+C ChicGrey | 3740 | 1 |
| 6550 27AC | 8M DPC SKT USB A+C ChicGrey | 3981 | 1 |

## Desktop Power Center

| Cat.Nos | Description | MRP*<br>₹ / Unit | Pack |
|---------|-------------|------------------|------|
|---------|-------------|------------------|------|

### Desktop Power Center (Empty)

To be equipped version of the DPC comes without the cord, installation kit, and accessories. It is compatible with Lyncus accessories, which need to be purchased separately.

|         |                                  |      |   |
|---------|----------------------------------|------|---|
| 6550 30 | 6M DPC (To Be Equipped) White    | 673  | 1 |
| 6550 31 | 6M DPC (To Be Equipped) ChicGrey | 774  | 1 |
| 6550 32 | 8M DPC (To Be Equipped) White    | 878  | 1 |
| 6550 33 | 8M DPC (To Be Equipped) ChicGrey | 1009 | 1 |

### Desktop Power Center DPC Accessories

The accessories come with three installation kits, each containing a different bracket: the Angle L Bracket, Flat I Bracket, and Wall Mount T Bracket. The L Bracket is included with the product, while the I Bracket and T Bracket are available for purchase separately.

|          |                                    |     |   |
|----------|------------------------------------|-----|---|
| 0269 88W | Cord with 3 Pin (BIS) Wh 1.5Mtr    | ■   | 1 |
| 0269 88B | Cord with 3 Pin (BIS) Black 1.5Mtr | ■   | 1 |
| 6550 36  | DPC Angle L-Bracket                | 163 | 1 |
| 6550 37  | DPC Flat I-Bracket                 | 149 | 1 |
| 6550 38  | DPC Wall T-Bracket                 | 218 | 1 |

\* MRP - Maximum Retail Price Inclusive of all taxes including GST.  
■ Price available on request.

Bold Cat.Nos are products normally available with Legrand (India) Stockists. Cat.Nos that are not bold - delivery within 4 - 8 weeks from the date of order. Bold packing quantity is our mandatory packing. Orders to be placed by Legrand (India) Stockist in multiples of the same.

**NEW!**

# DISQ 60 and DISQ 80

## Compact Desk Power for Modern Workspaces



DISQ 60 & DISQ 80 bring smart, desk-integrated power, USB, and data right where you need it. Built for modern workspaces, they blend seamlessly into desks and meeting tables—delivering instant connectivity while keeping surfaces sleek, clean, and clutter-free.

### Features

- Circular desk-mounted design for seamless integration into desks and meeting tables
- Integrated power and USB charging for laptops and everyday office devices
- Power sockets compliant with IS 1293 and USB compliant with IS 13252 standards
- Durable construction with IK07 impact resistance for reliable daily use

### Benefits

- Provides convenient power and charging access directly at the workspace
- Maintains clean desk aesthetics with minimal visual footprint
- Reduces cable clutter and dependence on external chargers or power strips
- Supports efficient and organised workspaces in offices and meeting rooms



Scan to know more about the product.

Everything you need.  
Right where you work



## Disq 60

INCARA DISQ 60 delivers sleek, discreet access to power or USB charging with quick, hassle-free installation.

- Ultimate flexibility – mount horizontally or vertically on any surface, from desks to sofas and lockers, with a patented system that fits even ultra-thin panels (1 mm).



## Disq 80

INCARA DISQ 80 combines power, data, and charging in one compact solution for modern, mobile users.

- Ideal for individual workstations, delivering seamless and efficient connectivity.
- Smart retrofit design – easily replaces existing cable outlets (80 mm Ø cut-out).
- Flexible configurations with 6 UTP sockets or cable outlets for quick, hassle-free access.

## NEW! Disq 60 and Disq 80

| Cat.Nos | Description | MRP*<br>₹ / Unit | Pack |
|---------|-------------|------------------|------|
|---------|-------------|------------------|------|

Supply voltage: 250V~  
Frequency: 50/60 Hz  
Sockets complies with IS 1293  
USB complies with IS 13252  
Resistance to impact: IK 07  
Operating temperature: from -5°C to +35°C  
Storage temperature: from -10°C to +70°C



6540 32

**6540 32** DISQ 60 1 6A SKT WH 3530 1



6540 29

**6540 29** DISQ 60 1 6A SKT BL 3530 1



6540 30

**6540 30** DISQ 60 1 USB A+C WH 6270 1



6540 31

**6540 31** DISQ 60 1 USB A+C BL 6270 1



6540 33

**6540 33** DISQ 80 1 6A SKT USB C 15W CABLE OUTLET WH 6240 1



6540 36

**6540 36** DISQ 80 1 6A SKT USB C 15W CABLE OUTLET BL 6240 1

**6540 34** DISQ 80 1 6A SKT USB A+C 15W RJ45 CAT6 WH 6550 1



6540 37

**6540 37** DISQ 80 1 6A SKT USB A+C 15W RJ45 CAT6 BL 6550 1



6540 39

**6540 39** DISQ 80 1 6A SKT USB C 15W CABLE OUTLET BL-METAL 6730 1



6540 40

**6540 40** DISQ 80 1 6A SKT USB C 15W RJ45 CAT6 BL-METAL 7070 1

\* MRP - Maximum Retail Price Inclusive of all taxes including GST.  
Red Cat.Nos - new products

Bold Cat.Nos are products normally available with Legrand (India) Stockists. Cat.Nos that are not bold - delivery within 4 - 8 weeks from the date of order. Bold packing quantity is our mandatory packing. Orders to be placed by Legrand (India) Stockist in multiples of the same.

# POP-UP BOXES For Floor

## Seamless Floor Design, Superior Protection



Pop-up Boxes for Floor provide discreet floor-mounted access to power, data, and AV connections in modern workspaces. With a slim profile, soft-opening mechanism, and durable construction, they integrate smoothly into floor systems while ensuring reliable connectivity for offices and collaborative environments.

### Features

- Extra-slim floor box design with corrosion-resistant, halogen-free construction
- Soft-opening cover with damper and push-slide locking mechanism
- Modular configuration for power, audio, video, and data using Arteor modules
- Robust protection: IP40 rating and IK07 impact resistance for high-traffic areas

### Benefits

- Maintains clean floor aesthetics with discreet connectivity access
- Reduces cable clutter by providing power and data at floor level
- Ensures durable performance in high-use commercial environments
- Enhances user convenience with smooth and secure opening operation



Scan to know more about  
the product.



## Pop Up Box

| Cat.Nos | Description | MRP*<br>₹ / Unit | Pack |
|---------|-------------|------------------|------|
|---------|-------------|------------------|------|

### Pop Up Flush Mounting Boxes For Floor To Be Equipped

Installation accessories should be considered additionally along with the pop up box.

For installation, use flush mounting boxes for concrete floors or kits for raised access floors.

To be equipped with Arteor accessories.

#### 3 modules

|         |                           |      |   |
|---------|---------------------------|------|---|
| 0540 10 | Pop-up 3M Aluminium       | 3795 | 1 |
| 0540 15 | Pop-up 3M Brass           | 4963 | 1 |
| 0540 20 | Pop-up 3M Stainless Steel | 5015 | 1 |

0540 15

0540 20

#### 4 Modules

|         |                           |      |   |
|---------|---------------------------|------|---|
| 0540 11 | Pop-up 4M Aluminium       | 5094 | 1 |
| 0540 16 | Pop-up 4M Brass           | 5872 | 1 |
| 0540 21 | Pop-up 4M Stainless Steel | 6357 | 1 |
| 0540 26 | Pop-up 4M Matt Black      | 5650 | 1 |
| 0540 31 | Pop-up 4M Glossy White    | 5783 | 1 |

0540 16

0540 21

0540 26

0540 31

#### 6 (2 x 3) Modules

|         |                           |       |   |
|---------|---------------------------|-------|---|
| 0540 12 | Pop-up 6M Aluminium       | 8516  | 1 |
| 0540 17 | Pop-up 6M Brass           | 10649 | 1 |
| 0540 22 | Pop-up 6M Stainless Steel | 11042 | 1 |

0540 12

0540 17

0540 22

\* MRP - Maximum Retail Price Inclusive of all taxes including GST.

## Pop Up Box

| Cat.Nos | Description | MRP*<br>₹ / Unit | Pack |
|---------|-------------|------------------|------|
|---------|-------------|------------------|------|

### 8 (2 x 4) Modules

|         |                           |       |   |
|---------|---------------------------|-------|---|
| 0540 13 | Pop-up 8M Aluminium       | 10546 | 1 |
| 0540 18 | Pop-up 8M Brass           | 12779 | 1 |
| 0540 23 | Pop-up 8M Stainless Steel | 13595 | 1 |
| 0540 28 | Pop-up 8M Matt Black      | 12141 | 1 |
| 0540 33 | Pop-up 8M Glossy White    | 12211 | 1 |

0540 18

0540 23

0540 28

0540 33

### Installation Kits For Raised Access Floors

Include an empty receptacle and fixing brackets for raised access floor tiles Compatible with:

- Cat. 6 data cabling
- Audio/video cabling

|         |                            |      |   |
|---------|----------------------------|------|---|
| 0540 05 | Installation Kit 3M Pop-up | 1576 | 1 |
| 0540 06 | Installation Kit 4M Pop-up | 1892 | 1 |
| 0540 07 | Installation Kit 6M Pop-up | 2623 | 1 |
| 0540 08 | Installation Kit 8M Pop-up | 3238 | 1 |

0540 06

### For Installation Of Pop-Up Floor Boxes In Concrete Floors

Equipped with knockouts for  $\varnothing$  20 and  $\varnothing$  25 mm conduits

#### Metal Flush-Mounting Boxes

|         |                             |      |   |
|---------|-----------------------------|------|---|
| 0540 00 | Back Box Concrete 3M Pop-up | 408  | 1 |
| 0540 01 | Back Box Concrete 4M Pop-up | 540  | 1 |
| 0540 02 | Back Box Concrete 6M Pop-up | 863  | 1 |
| 0540 03 | Back Box Concrete 8M Pop-up | 1085 | 1 |

0540 00

Bold Cat.Nos are products normally available with Legrand (India) Stockists. Cat.Nos that are not bold - delivery within 4 - 8 weeks from the date of order. Bold packing quantity is our mandatory packing. Orders to be placed by Legrand (India) Stockist in multiples of the same.

# Floor Boxes

## A Perfect Fit in any Commercial Space



Designed for project managers, consultants, architects, and end users alike, this modern solution is crafted for evolving spaces and dynamic environments. It blends seamlessly into contemporary architecture, enhancing the overall look and feel of any interior.

### Features

- Modular 45 mm system for maximum flexibility
- Multiple sizes & capacities (8 to 24 modules)
- Horizontal & vertical configurations for smart space use
- Premium finish options (plastic / stainless steel, flush or frame)

### Benefits

- Faster installation, lower labour cost (tool-free snap-in system)
- Seamless integration with any floor finish (clean, modern look)
- Fully customizable for power, data & multimedia needs
- Reliable & compliant for long-term performance and safety

Scan to know more about the product.



Frame & lid version  
Plastic LID

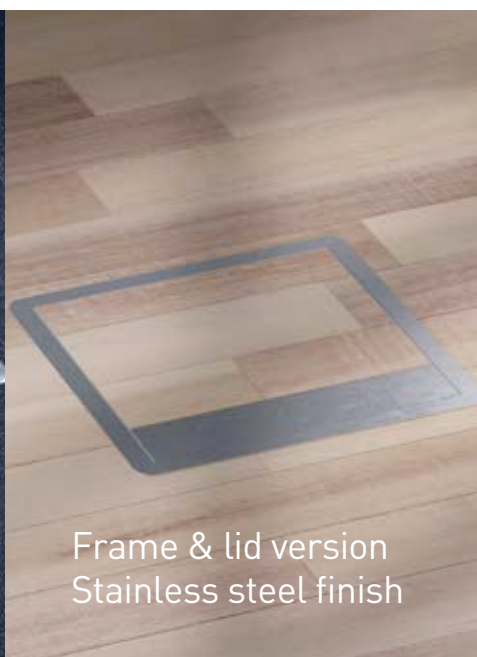

Frame & lid version  
Stainless steel finish



Flush lid version  
Stainless steel finish

## Floor Solution

| Cat.Nos | Description | MRP*<br>₹ / Unit | Pack |
|---------|-------------|------------------|------|
|---------|-------------|------------------|------|

### Selection Chart

|  |   |                       |   |                              |
|--|---|-----------------------|---|------------------------------|
| Back Box                                   | + | Lid & Trim            | + | Support Plate                |
| Floor Box for Raised Floor                 |   |                       |   |                              |
| 6896 38                                    | + | 689631                | + | 689662/<br>689617/<br>689678 |
| Floor Box for screed Floor (3 Compartment) |   |                       |   |                              |
| 6896 34                                    | + | 689631                | + | 689662/<br>689617/<br>689678 |
| Floor Box for screed Floor (4 Compartment) |   |                       |   |                              |
| 6896 45                                    | + | 689641                | + | 89662/<br>689617/<br>689678  |
| Floor box for Tiles/Marble                 |   |                       |   |                              |
| 0896 04                                    | + | 689652/689655/689656+ | + | 689662/<br>689617/<br>689678 |
| 50 Reduced Height Floor Box                |   |                       |   |                              |
| 0880 73                                    | + | 088070                | + | 689662/<br>689617/<br>689678 |

### Regular Floor Boxes Range

#### Floor Boxes for Raised & Screed Floor ( 3-CMP)

|         |                                     |      |   |
|---------|-------------------------------------|------|---|
| 6896 38 | RF Backbox for 3-CPM (For Carpet)   | 6141 | 1 |
| 6896 34 | SF Backbox For 3-CPM (For Carpet)   | 9612 | 1 |
| 6896 31 | 265X265 Lid & Trim Carpet 8MM 3-CPM | 4684 | 5 |

#### Regular Floor Boxes for Screed Floor ( 4-CMP)

|         |                   |       |   |
|---------|-------------------|-------|---|
| 6896 45 | Backbox for 4-CPM | 10541 | 1 |
| 6896 41 | Lid & Trim 4-CPM  | 5067  | 1 |

#### Stainless Steel Insert for Lid

For a metal finish on lid  
To be used instead of fitting carpet onto the Lid

|         |                   |      |   |
|---------|-------------------|------|---|
| 6896 92 | SS Insert For Lid | 5700 | 1 |
|---------|-------------------|------|---|

## Floor Solution

| Cat.Nos | Description | MRP*<br>₹ / Unit | Pack |
|---------|-------------|------------------|------|
|---------|-------------|------------------|------|

### Floor Boxes for Tile / Marble

|         |   |       |   |
|---------|---|-------|---|
| 0896 04 | Backbox (For Tile)                            | 7917  | 1 |
| 6896 52 | Floor Box Tile 15 To 22MM                     | 39710 | 1 |
| 6896 55 | Lid/Trim Grey Painted Headband Tile 8 To 15MM | 10891 | 5 |
| 6896 56 | Lid/Trim SS Headband Tile 8 To 15MM           | 12520 | 5 |

### Reduced Height Vertical Floor Box - 50mm

|         |                            |       |   |
|---------|----------------------------|-------|---|
| 0880 73 | Back Box (Use With 088070) | 11683 | 1 |
| 0880 70 | Lid & Trim 50 To 70 MM     | 11537 | 1 |
| 0880 72 | SS Insert PL For 50MM FB   | 7351  | 5 |

### Support Plates for Regular Floor Boxes

77 mm with plate

|         |                         |      |    |
|---------|-------------------------|------|----|
| 689662L | Blank Plate             | 497  | 12 |
| 6896 17 | Support Plate Myrius 8M | 532  | 1  |
| 6896 78 | Support Plate Waved     | 1538 | 5  |

### NEW! Heavy Duty Floor Boxes IP40

|                |                                     |        |   |
|----------------|-------------------------------------|--------|---|
| <b>0880 80</b> | Boite encast réglable 55-125        | 19284  | 1 |
| <b>0880 86</b> | 4 screws for height extension feets | 3750   | 1 |
| <b>0880 88</b> | Foam block for height extension     | 8200   | 1 |
| <b>0896 82</b> | Heavy load support 15KN             | 65750  | 1 |
| <b>0896 85</b> | Access trap for junction            | 54752  | 1 |
| <b>0896 86</b> | Floor box with direct central exit  | 116549 | 1 |
| <b>0896 87</b> | Cable exit accessory - IP52         | 62273  | 1 |

Bold Cat.Nos are products normally available with Legrand (India) Stockists. Cat.Nos that are not bold - delivery within 4 - 8 weeks from the date of order. Bold packing quantity is our mandatory packing. Orders to be placed by Legrand (India) Stockist in multiples of the same.

\* MRP - Maximum Retail Price Inclusive of all taxes including GST. For regular floor boxes height adjustment is 65-90mm without accessories and 77-90mm with accessories.  
**Red Cat.Nos - new products**

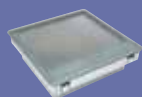

6896 38 +  
6896 31



6896 34 +  
6896 31

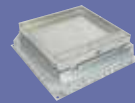

0896 04 +  
6896 52

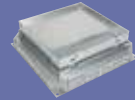

0896 04 +  
6896 55



0880 73

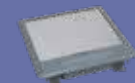

0880 70



0880 72

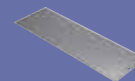

689662L



6896 17



6896 78



0880 80



0896 82



0896 87

## Floor Solution

| Cat.Nos | Description | MRP*<br>₹ / Unit | Pack |
|---------|-------------|------------------|------|
|---------|-------------|------------------|------|

### NEW! New Floor Boxes

#### Plastic Grey Lid and Trim

|         |                                    |       |   |
|---------|------------------------------------|-------|---|
| 0807 09 | Frame & Lid Plastic Screed 12 M Hz | 6150  | 1 |
| 0807 10 | Frame & Lid Plastic Screed 18 M Hz | 6680  | 1 |
| 0807 11 | Frame & Lid Plastic Screed 24 M Hz | 7970  | 1 |
| 0807 12 | Frame & Lid Plastic Screed 8 M Vt  | 7760  | 1 |
| 0807 13 | Frame & Lid Plastic Screed 12 M Vt | 9540  | 1 |
| 0807 14 | Frame & Lid Plastic Screed 16 M Vt | 11340 | 1 |



### NEW! Metal SS Finish Lid and Trim

|         |                                  |       |   |
|---------|----------------------------------|-------|---|
| 0807 27 | Frame & Lid Metal Screed 12 M Hz | 26520 | 1 |
| 0807 28 | Frame & Lid Metal Screed 18 M Hz | 27430 | 1 |
| 0807 29 | Frame & Lid Metal Screed 24 M Hz | 28930 | 1 |
| 0807 30 | Frame & Lid Metal Screed 8 M Vt  | 28180 | 1 |
| 0807 31 | Frame & Lid Metal Screed 12 M Vt | 30400 | 1 |
| 0807 32 | Frame & Lid Metal Screed 16 M Vt | 32410 | 1 |



### NEW! Flush Metal SS Finish Lid & Trim

|         |                                    |       |   |
|---------|------------------------------------|-------|---|
| 0807 45 | Flush Concrete Floor 12 Modules Hz | 29450 | 1 |
| 0807 46 | Flush Concrete Floor 18 Modules Hz | 35420 | 1 |
| 0807 47 | Flush Concrete Floor 24 Modules Hz | 36560 | 1 |
| 0807 48 | Flush Concrete Floor 8 Modules Vt  | 31000 | 1 |
| 0807 49 | Flush Concrete Floor 12 Modules Vt | 38390 | 1 |



## Floor Solution

| Cat.Nos | Description | MRP*<br>₹ / Unit | Pack |
|---------|-------------|------------------|------|
|---------|-------------|------------------|------|

|         |                                    |       |   |
|---------|------------------------------------|-------|---|
| 0807 50 | Flush Concrete Floor 16 Modules Vt | 39900 | 1 |
|---------|------------------------------------|-------|---|



### Universal Adjustable Backbox

|         |                             |       |   |
|---------|-----------------------------|-------|---|
| 0880 80 | Universal Back Box 55-125MM | 19284 | 1 |
|---------|-----------------------------|-------|---|

### Mounting Adaptors For Screed Floor

|         |                             |      |   |
|---------|-----------------------------|------|---|
| 0880 81 | Adaptation Plate for 8/12M  | 4173 | 1 |
| 0880 82 | Adaptation Plate for 12/18M | 4512 | 1 |
| 0880 83 | Adaptation Plate for 16/24M | 4830 | 1 |



### Auto-Adjusting Backbox

|         |                         |      |   |
|---------|-------------------------|------|---|
| 0880 90 | Back Box 8/12M 65-90MM  | 5772 | 1 |
| 0880 91 | Back Box 12/18M 65-90MM | 6998 | 1 |
| 0880 92 | Back Box 16/24M 65-90MM | 8213 | 1 |



### NEW! Reno Back Box

|         |                                |      |   |
|---------|--------------------------------|------|---|
| 0881 90 | Reno Back Box for Std Fb 8/12m | 4650 | 1 |
| 0881 91 | Reno Backbox for Std Fb 12/18m | 5160 | 1 |
| 0881 92 | Reno Backbox for Std Fb 16/24m | 5070 | 1 |



### Finish Plates

|        |                          |      |   |
|--------|--------------------------|------|---|
| 088015 | SS Plate Grey Lid 8/12M  | 5667 | 1 |
| 088016 | SS Plate Grey Lid 12/18M | 5802 | 1 |
| 088017 | SS Plate Grey Lid 16/24M | 7872 | 1 |

\* MRP - Maximum Retail Price Inclusive of all taxes including GST.  
Red Cat.Nos - new products

Bold Cat.Nos are products normally available with Legrand (India) Stockists. Cat.Nos that are not bold - delivery within 4 - 8 weeks from the date of order. Bold packing quantity is our mandatory packing. Orders to be placed by Legrand (India) Stockist in multiples of the same.

## Floor Solution



| Cat.Nos | Description               | MRP*<br>₹ / Unit | Pack |
|---------|---------------------------|------------------|------|
| 088045  | SS Plate Metal Lid 8/12M  | 8426             | 1    |
| 088046  | SS Plate Metal Lid 12/18M | 9670             | 1    |
| 088047  | SS Plate Metal Lid 16/24M | 10994            | 1    |

## Floor Boxes 3 Module

Conform to EN 50 085 2.2 and EN 60670 23

**IP 20/IK07**

Compression test, 500N / 1cm<sup>2</sup> during 1 min :

Comply with norm CEI 60670 23 (2004)



|        |                       |      |   |
|--------|-----------------------|------|---|
| 089644 | Floor Box 3M          | 2499 | 1 |
| 089649 | Flush Mounting Box 3M | 1663 | 1 |

## IP66 Floor Box

IP66 Floor box complies with the IEC 60670 1 and IEC 60670 23 standards.

Resistance to loads: with the cover closed: 10000 N

Resistance to impacts: IK 09 with the cover closed

Self extinguishing : + 650° C / 30 s for parts made of insulating materials.









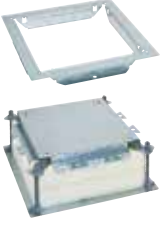

|        |   |       |   |
|--------|---|-------|---|
| 088061 | IP66/IK09 Screwed SS Floor Box            | 27291 | 1 |
| 088064 | IP66/IK09 Hinged CVR SS Floor Box         | 32052 | 1 |
| 088069 | Back Box IP66 Floor, Min Screed Height 65 | 5237  | 1 |
| 088062 | IP55 Cable Exit Accessory                 | 30401 | 1 |
| 089307 | Floor Access Unit Circular                | 11683 | 1 |

\* MRP - Maximum Retail Price Inclusive of all taxes including GST.  
Red Cat.Nos - new products

Bold Cat.Nos are products normally available with Legrand (India) Stockists.  
Cat.Nos that are not bold - delivery within 4 - 8 weeks from the date of order.  
Bold packing quantity is our mandatory packing. Orders to be placed by Legrand (India) Stockist in multiples of the same.

## Frame and Lid Floor Boxes for Concrete Floor Selection Chart



| FLOOR BOX TYPE  | FLOOR BOX CAPACITY | FLOOR BOX CAT.NOS | BACKBOX TO SELECT ACCORDING TO CONCRETE SCREED DEPTH                              |   |  |   |   | FINISHING PLATES (OPTIONAL) |          |          |
|---|--------------------|-------------------|---|---|--|---|---|-----------------------------|----------|----------|
|   |                    |                   |  |  |  |  |  |                             |          |          |
| <b>SOCKETS IN HORIZONTAL POSITION</b>   |                    |                   | <b>77 - 90<sup>(1)(2)</sup> mm</b>  | <b>80 - 110<sup>(2)</sup> mm</b>  | <b>76 - 125<sup>(2)</sup> mm</b>   | <b>110 - 170 mm</b>   | <b>150 - 250 mm</b>   |                             |          |          |
| <b>PLASTIC FRAME AND LID</b><br>   | 12 (3 x 4) modules | 0 807 09          | 0 880 90  | 0 881 90  | 0 880 80 + 0 880 81  | +   | 0 880 88 + 0 880 86   | +                           | 0 880 88 | 0 880 15 |
|   | 18 (3 x 6) modules | 0 807 10          | 0 880 91  | 0 881 91  | 0 880 80 + 0 880 82  |   |   |                             |          | 0 880 16 |
|   | 24 (3 x 8) modules | 0 807 11          | 0 880 92  | 0 881 92  | 0 880 80 + 0 880 83  |   |   |                             |          | 0 880 17 |
| <b>METAL FRAME AND LID</b><br>    | 12 (3 x 4) modules | 0 807 27          | 0 880 90  | 0 881 90  | 0 880 80 + 0 880 81  |   |   |                             |          | 0 880 45 |
|   | 18 (3 x 6) modules | 0 807 28          | 0 880 91  | 0 881 91  | 0 880 80 + 0 880 82  |   |   |                             |          | 0 880 46 |
|   | 24 (3 x 8) modules | 0 807 29          | 0 880 92  | 0 881 92  | 0 880 80 + 0 880 83  |   |   |                             |          | 0 880 47 |
| <b>SOCKETS IN VERTICAL POSITION</b>   |                    |                   | <b>69 - 90<sup>(1)</sup> mm</b>   | <b>72 - 110 mm</b>  | <b>68 - 125 mm</b>   | <b>110 - 170 mm</b>   | <b>150 - 250 mm</b>   |                             |          |          |
| <b>PLASTIC FRAME AND LID</b><br> | 8 (2 x 4) modules  | 0 807 12          | 0 880 90  | 0 881 90  | 0 880 80 + 0 880 81  | +   | 0 880 88 + 0 880 86   | +                           | 0 880 88 | 0 880 15 |
|   | 12 (2 x 6) modules | 0 807 13          | 0 880 91  | 0 881 91  | 0 880 80 + 0 880 82  |   |   |                             |          | 0 880 16 |
|   | 16 (2 x 8) modules | 0 807 14          | 0 880 92  | 0 881 92  | 0 880 80 + 0 880 83  |   |   |                             |          | 0 880 17 |
| <b>METAL FRAME AND LID</b><br>   | 8 (2 x 4) modules  | 0 807 30          | 0 880 90  | 0 881 90  | 0 880 80 + 0 880 81  |   |   |                             |          | 0 880 45 |
|   | 12 (2 x 6) modules | 0 807 31          | 0 880 91  | 0 881 91  | 0 880 80 + 0 880 82  |   |   |                             |          | 0 880 46 |
|   | 16 (2 x 8) modules | 0 807 32          | 0 880 92  | 0 881 92  | 0 880 80 + 0 880 83  |   |   |                             |          | 0 880 47 |

1: From 90 mm to 200 mm with the fixing kit for elevating and leveling Cat.No 0 807 55















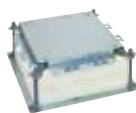

2: Minimum dimensions when used with straight plugs

## Frame and Lid Floor Boxes for Concrete Floor

### Selection Chart

| FLOOR BOX TYPE   | FLOOR BOX CAPACITY | FLOOR BOX CAT.NOS | BACKBOX TO SELECT ACCORDING TO CONCRETE SCREED DEPTH |                                  |                     |                                      | FINISHING PLATES (OPTIONAL) |
|--|--------------------|-------------------|--|----------------------------------|---------------------|--------------------------------------|-----------------------------|
|  |                    |                   | 89 - 90 <sup>(1)(2)</sup> mm                         | 88 - 122 <sup>(2)</sup> mm       | 110 - 170 mm        | 150 - 250 mm                         |                             |
| <b>SOCKETS IN HORIZONTAL POSITION</b>  |                    |                   | <b>89 - 90<sup>(1)(2)</sup> mm</b>                   | <b>88 - 122<sup>(2)</sup> mm</b> | <b>110 - 170 mm</b> | <b>150 - 250 mm</b>                  |                             |
|   | 12 (3 x 4) modules | 0 807 45          | 0 880 90   | 0 880 80 + 0 880 81              | +                   | 0 880 88 +<br>0 880 86 +<br>0 881 42 | 0 881 45                    |
|  | 18 (3 x 6) modules | 0 807 46          | 0 880 91   | 0 880 80 + 0 880 82              |                     |                                      | 0 881 46                    |
|  | 24 (3 x 8) modules | 0 807 47          | 0 880 92   | 0 880 80 + 0 880 83              |                     |                                      | 0 881 47                    |
| <b>SOCKETS IN VERTICAL POSITION</b>  |                    |                   | <b>82 - 90<sup>(1)</sup> mm</b>                      | <b>81 - 122 mm</b>               | <b>110 - 170 mm</b> | <b>150 - 250 mm</b>                  |                             |
|  | 8 (2 x 4) modules  | 0 807 48          | 0 880 90   | 0 880 80 + 0 880 81              | +                   | 0 880 88 +<br>0 880 86 +<br>0 881 42 | 0 881 45                    |
|  | 12 (2 x 6) modules | 0 807 49          | 0 880 91   | 0 880 80 + 0 880 82              |                     |                                      | 0 881 46                    |
|  | 16 (2 x 8) modules | 0 807 50          | 0 880 92   | 0 880 80 + 0 880 83              |                     |                                      | 0 881 47                    |

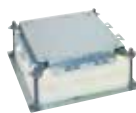
## Mouting Principle

|   |   |   |    |   |    |   |   |   |    |   |    |   |   |   |
|---|---|---|----|---|----|---|---|---|----|---|----|---|---|---|
|  | = |  | OR |  | OR |  | + |  | OR |  | OR |  | + |  |
| Floor box with sockets in horizontal position                                       |   | Type : Standard Frame : Horizontal Lid : Plastic Grey                               |    | Type : Standard Frame : Horizontal Lid : SS Finish                                  |    | Type : Flush Frame : Horizontal Lid : SS Finish                                     |   | Regular Back Box  |    | Box (Plastic) (Not compatible with Flush type Lid)                                    |    | Universal adjustable Back Box   |   | Arteor Accessories  |
|  | = |  | OR |  | OR |  | + |  | OR |  | OR |  | + |  |
| Floor box with sockets in vertical position   |   | Type : Standard Frame : Vertical Lid : Plastic Grey                                 |    | Type : Standard Frame : Vertical Lid : SS Finish                                    |    | Type : Flush Frame : Vertical Lid : SS Finish                                       |   | Regular Back Box  |    | Box (Plastic) (Not compatible with Flush type Lid)                                    |    | Universal adjustable Back Box   |   | Arteor Accessories  |

# DLP™ Mini-Trunking

## Flexible and Aesthetic Cable Management Solution



DLP™ Mini-Trunking offers a practical solution for organized cable routing, protection, and distribution in electrical installations. Its modular design enables neat cable management while supporting easy integration of wiring accessories across residential, commercial, and service environments.

### Features

- Flexible system to adapt to every kind of wall-building configuration
- A new aesthetics, colour : RAL 9003 brilliant white
- A RoHS product = lead free product.
- High resistance against UV to limit the change of the colour during the life of the installation
- Non-Flame Propagating; material : high impact self-extinguishing

### Benefits

- Simplifies installation with clip-on assembly and easy maintenance access
- Ensures organized cable routing with safe separation of circuits
- Provides durable protection with IP40 enclosure and IK07 impact resistance
- Delivers a clean aesthetic finish suitable for visible installations



\*This is a design-and-build product. Design support can be provided as required. Pricing is available upon request and is not included in this price list.

Scan to know more about  
the product.



| Cat.Nos  | Description                  | MRP*<br>₹ / Unit | Pack              |
|--|------------------------------|------------------|-------------------|
| <b>DLP Mini Trunking</b>   |                              |                  |                   |
| <b>Mini-trunking system</b><br>Standard length 2 meters; Price per meter<br>Mini-trunking - 32 x 12.5 mm |                              |                  |                   |
| 0300 15  | Mini TRK 32X125 White        | 202              | 80 <sup>(1)</sup> |
| <b>Finishing Accessories</b>   |                              |                  |                   |
| 0312 03  | End Cap For 32X125           | 112              | 20/400            |
| 0302 51  | Int/Ext Angle For 32X125     | 154              | 10/100            |
| 0302 53  | Flat Angle For 32X125        | 166              | 10/100            |
| 0302 54  | Flat Junction For 32X125     | 217              | 10/200            |
| 0336 03  | White 32X10/125 Cover Gasket | 218              | 20                |
| <b>Mini-Trunking - 32 x 16 mm</b>  |                              |                  |                   |
| 0308 04  | Mini TRK 32X16 White 210     | 269              | 60 <sup>(1)</sup> |
| <b>Finishing Accessories</b>   |                              |                  |                   |
| 0312 07  | End Cap For 32X16            | 163              | 10                |
| 0333 25  | Int/Ext Angle For 32X16      | 217              | 10                |
| <b>Mini-Trunking - 32 x 20 mm</b>  |                              |                  |                   |
| 0300 17  | Mini TRK 32X20 White 210     | 352              | 50 <sup>(1)</sup> |
| <b>Finishing Accessories</b>   |                              |                  |                   |
| 0312 09  | End Cap For 32X20            | 234              | 10                |
| 0302 71  | Int/Ext Angle For 32X20      | 217              | 10                |
| 0302 73  | Flat Angle For 32X20         | 272              | 10                |
| 0302 74  | Flat Junction For 32X20      | 459              | 10                |
| 0336 04  | White 32X16/20 Cover Gasket  | 315              | 20                |

## DLP Mini Trunking Systems

For Cable Distribution

### Selection Chart for DLP Mini Trunking

|              | Length     | Finishing Accessories |                       |                       |                   | Junction Elements    |
|--------------|------------|-----------------------|-----------------------|-----------------------|-------------------|----------------------|
|              |            |                       |                       |                       |                   |                      |
| <b>WHITE</b> | <b>2 m</b> | <b>End cap</b>        | <b>Internal angle</b> | <b>External angle</b> | <b>Flat angle</b> | <b>Flat junction</b> |
| 32 x 12.5    | 0300 15    | 0312 03               | 0302 51               | 0302 51               | 0302 53           | 0302 54              |
| 32 x 16      | 0308 04    | 0312 07               | 0333 25               | 0333 25               | 0333 27           | 0333 30              |
| 32 x 20      | 0300 17    | 0312 09               | 0302 71               | 0302 71               | 0302 73           | 0302 74              |

Bold Cat.Nos are products normally available with Legrand (India) Stockists. Cat.Nos that are not bold - delivery within 4 - 8 weeks from the date of order. Bold packing quantity is our mandatory packing. Orders to be placed by Legrand (India) Stockist in multiples of the same.

# DLP-S

## UNIVERSAL TRUNKING

### FOR THE ESSENTIALS

- Traditional installation method with modular or with universal supports
- Compatible with all types of 45 mm mechanisms (like Arteor)

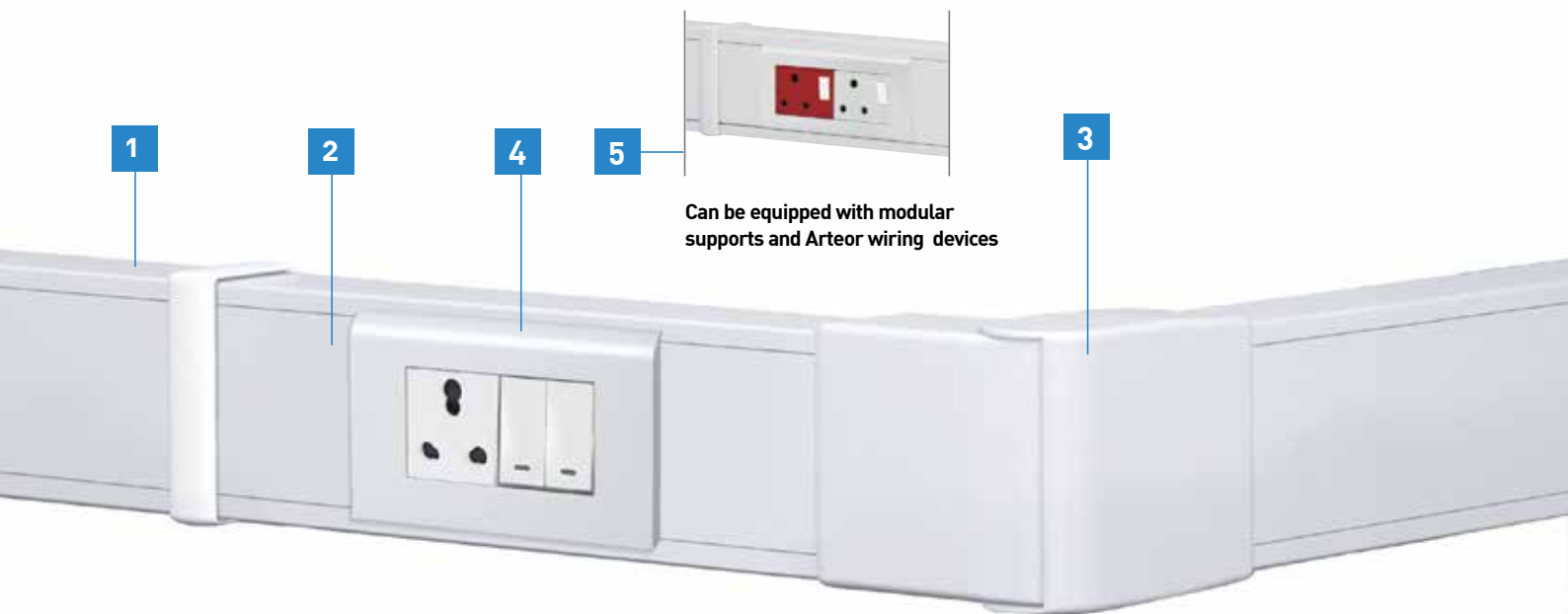

1 Rigid profiles with perforations



2 Self-guiding cover

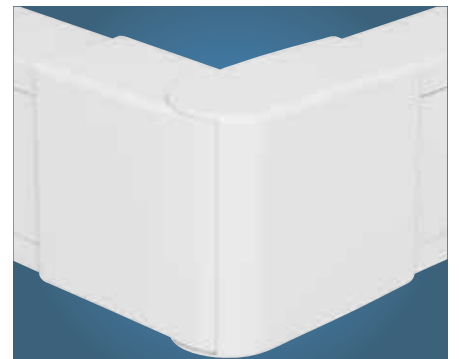

3 Ready to install accessories



Scan to know more about the product.



**4** Myrius single module switch with brackets

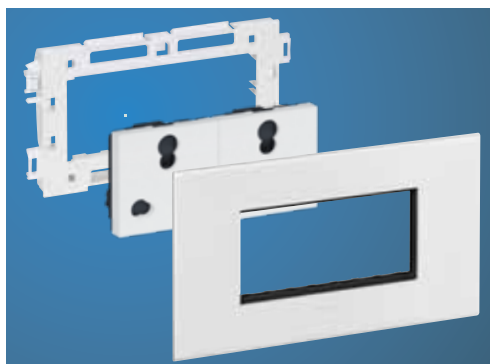

**5** Arteor sockets and modular support

## DLP-S Universal Trunking

| Cat.Nos | Description | MRP*<br>₹ / Unit | Pack |
|---------|-------------|------------------|------|
|---------|-------------|------------------|------|

Standard length 2 meters; Price per meter  
Trunking

### Body with cover

|         |                           |      |                   |
|---------|---------------------------|------|-------------------|
| 6380 38 | DLP-S TRK+CVR<br>100X502M | 1435 | 12 <sup>(1)</sup> |
|---------|---------------------------|------|-------------------|

### Partition

|         |                            |     |                   |
|---------|----------------------------|-----|-------------------|
| 6380 08 | DLP-S Separation Partition | 336 | 32 <sup>(1)</sup> |
|---------|----------------------------|-----|-------------------|

### Joints

|         |                         |     |    |
|---------|-------------------------|-----|----|
| 6380 36 | DLP-S Body Joint 100X50 | 160 | 10 |
| 6380 01 | DLP-S Cover Joint 75    | 237 | 50 |

### Angles and end caps

#### Variable angles

|         |                                    |     |    |
|---------|------------------------------------|-----|----|
| 6380 31 | DLP-S Variable Int Angle<br>100X50 | 700 | 10 |
| 6380 32 | DLP-S Variable Ext Angle<br>100X50 | 700 | 10 |

#### Fixed angles

|         |                               |     |    |
|---------|-------------------------------|-----|----|
| 6380 11 | DLP-S Int Angle For<br>100X50 | 362 | 20 |
| 6380 12 | DLP-S Ext Angle For<br>100X50 | 372 | 20 |

#### Flat angle

|         |                                |     |    |
|---------|--------------------------------|-----|----|
| 6380 13 | DLP-S Flat Angle For<br>100X50 | 803 | 16 |
|---------|--------------------------------|-----|----|

#### End cap

|         |                      |     |    |
|---------|----------------------|-----|----|
| 6380 35 | DLP-S End Cap 100X50 | 204 | 20 |
|---------|----------------------|-----|----|

#### Bracket

|         |                    |     |        |
|---------|--------------------|-----|--------|
| 6380 05 | DLP-S Bracket CV80 | 169 | 10/100 |
|---------|--------------------|-----|--------|

#### Junction

|         |                  |      |   |
|---------|------------------|------|---|
| 6380 34 | DLP-S Tee 100X50 | 1763 | 5 |
|---------|------------------|------|---|

### Supports for Mounting Wiring Accessories

#### Arteor™ & Myrius supports

Clip-on supports which can be fitted side by side  
Supplied with finishing plate

|         |                       |     |    |
|---------|-----------------------|-----|----|
| 6380 71 | DLP-S 2 Modules Frame | 440 | 10 |
| 6380 72 | DLP-S 4 Modules Frame | 640 | 5  |
| 6380 73 | DLP-S 6 Modules Frame | 759 | 5  |

\* MRP - Maximum Retail Price Inclusive of all taxes including GST.

Bold Cat.Nos are products normally available with Legrand (India) Stockists.  
Cat.Nos that are not bold - delivery within 4 - 8 weeks from the date of order.  
Bold packing quantity is our mandatory packing. Orders to be placed by  
Legrand (India) Stockist in multiples of the same.

## P17 Tempra Pro IP 44 - LV 16 and 32 A - Sockets and Plugs

| Cat.Nos | Description | MRP*<br>₹ / Unit | Pack |
|---------|-------------|------------------|------|
|---------|-------------|------------------|------|

### Surface Mounting Sockets

|         |                         |      |    |
|---------|-------------------------|------|----|
| 5551 54 | 200/250 VA, 16 A 2P+E   | 971  | 10 |
| 5551 58 | 380/415 VA, 16 A 3P+E   | 1197 | 10 |
| 5551 59 | 380/415 VA, 16 A 3P+N+E | 1268 | 10 |
| 5552 54 | 200/250 VA, 32 A 2P+E   | 1213 | 5  |
| 5552 58 | 380/415 VA, 32 A 3P+E   | 1518 | 10 |
| 5552 59 | 380/415 VA, 32 A 3P+N+E | 1610 | 10 |

### Panel Mounting Sockets Inclined Outlet

|         |                         |      |    |
|---------|-------------------------|------|----|
| 5551 84 | 200/250 VA, 16 A 2P+E   | 602  | 10 |
| 5551 88 | 380/415 VA, 16 A 3P+E   | 885  | 10 |
| 5551 89 | 380/415 VA, 16 A 3P+N+E | 933  | 10 |
| 5552 84 | 200/250 VA, 32 A 2P+E   | 926  | 10 |
| 5552 88 | 380/415 VA, 32 A 3P+E   | 1170 | 10 |
| 5552 89 | 380/415 VA, 32 A 3P+N+E | 1240 | 10 |

### Mobile Sockets

|         |                         |      |    |
|---------|-------------------------|------|----|
| 5551 04 | 200/250 VA, 16 A 2P+E   | 784  | 10 |
| 5551 08 | 380/415 VA, 16 A 3P+E   | 873  | 10 |
| 5551 09 | 380/415 VA, 16 A 3P+N+E | 926  | 10 |
| 5552 14 | 200/250 VA, 32 A 2P+E   | 1040 | 10 |
| 5552 18 | 380/415 VA, 32 A 3P+E   | 1249 | 10 |
| 5552 19 | 380/415 VA, 32 A 3P+N+E | 1320 | 10 |

### Straight Plugs

|         |                         |      |    |
|---------|-------------------------|------|----|
| 5551 24 | 200/250 VA, 16 A 2P+E   | 556  | 10 |
| 5551 28 | 380/415 VA, 16 A 3P+E   | 682  | 10 |
| 5551 29 | 380/415 VA, 16 A 3P+N+E | 716  | 10 |
| 5552 34 | 200/250 VA, 32 A 2P+E   | 837  | 10 |
| 5552 38 | 380/415 VA, 32 A 3P+E   | 955  | 10 |
| 5552 39 | 380/415 VA, 32 A 3P+N+E | 1012 | 10 |

## P17 Tempra - Domestic Pin Configuration 16 A - 250 VA

### Flush-Mounting Boxes

|         |  |      |   |
|---------|--|------|---|
| 0577 21 | For 2 panel mounting sockets With single fixing centres<br>70 x 70 mm - 16 A   | 5499 | 3 |
| 0577 22 | For 1 panel mounting socket With single fixing centres<br>70 x 70 mm - 16 or 32 A<br>(32 A to be fixed horizontally) | 3300 | 3 |

\* MRP - Maximum Retail Price Inclusive of all taxes including GST.

## P17 Tempra Pro IP 66/67 LV 16 and 32 A

| Cat.Nos | Polarity | MRP*<br>₹ / Unit | Pack |
|---------|----------|------------------|------|
|---------|----------|------------------|------|

### Surface Mounting Sockets

|         |                         |      |   |
|---------|-------------------------|------|---|
| 5553 54 | 200/250 V~, 16 A 2P+E   | 1623 | 5 |
| 5553 58 | 380/415 V~, 16 A 3P+E   | 1806 | 5 |
| 5553 59 | 380/415 V~, 16 A 3P+N+E | 1965 | 5 |
| 5554 54 | 200/250 V~, 32 A 2P+E   | 1924 | 5 |
| 5554 55 | 200/250 V~, 32 A 3P+E   | 3324 | 5 |
| 5554 59 | 380/415 V~, 32 A 3P+N+E | 3602 | 5 |

### Panel Mounting Sockets

|         |                         |      |   |
|---------|-------------------------|------|---|
| 5553 84 | 200/250 V~, 16 A 2P+E   | 1188 | 5 |
| 5553 88 | 380/415 V~, 16 A 3P+E   | 1263 | 5 |
| 5553 89 | 380/415 V~, 16 A 3P+N+E | 1343 | 5 |
| 5554 84 | 200/250 V~, 32 A 2P+E   | 1507 | 5 |
| 5554 88 | 380/415 V~, 32 A 3P+E   | 1726 | 5 |
| 5554 89 | 380/415 V~, 32 A 3P+N+E | 1833 | 5 |

### Mobile Sockets

|         |                         |      |   |
|---------|-------------------------|------|---|
| 5553 04 | 200/250 V~, 16 A 2P+E   | 1452 | 5 |
| 5553 08 | 380/415 V~, 16 A 3P+E   | 1806 | 5 |
| 5553 09 | 380/415 V~, 16 A 3P+N+E | 1917 | 5 |
| 5554 14 | 200/250 V~, 32 A 2P+E   | 1995 | 5 |
| 5554 18 | 380/415 V~, 32 A 3P+E   | 2132 | 5 |
| 5554 19 | 380/415 V~, 32 A 3P+N+E | 2264 | 5 |

### Straight Plugs

|         |                         |      |   |
|---------|-------------------------|------|---|
| 5553 24 | 200/250 V~, 16 A 2P+E   | 1263 | 5 |
| 5553 28 | 380/415 V~, 16 A 3P+E   | 1386 | 5 |
| 5553 29 | 380/415 V~, 16 A 3P+N+E | 1473 | 5 |
| 5554 34 | 200/250 V~, 32 A 2P+E   | 1710 | 5 |
| 5554 38 | 380/415 V~, 32 A 3P+E   | 1797 | 5 |
| 5554 39 | 380/415 V~, 32 A 3P+N+E | 1906 | 5 |

## Metra Plugs And Sockets

### Plugs

#### Ivory

|         |                   |     |         |
|---------|-------------------|-----|---------|
| 6500 22 | 240 V, 10 A, 2P+E | 260 | 1/5/100 |
| 6500 28 | 240 V, 20 A, 2P+E | 273 | 1/5/100 |

#### Grey

|         |                   |     |         |
|---------|-------------------|-----|---------|
| 6500 02 | 240 V, 10 A, 2P+E | 260 | 1/5/100 |
| 6500 08 | 240 V, 20 A, 2P+E | 273 | 1/5/100 |
| 6500 10 | 440 V, 20 A, 3P+E | 364 | 1/5/100 |
| 6500 16 | 440 V, 32 A, 3P+E | 685 | 1/5/100 |

### Sockets

|         |                                     |     |         |
|---------|-------------------------------------|-----|---------|
| 6500 03 | 240 V, 10 A, 2P+E<br>With blue cap  | 264 | 1/5/100 |
| 6500 23 | 240 V, 10 A, 2P+E<br>With ivory cap | 264 | 1/5/100 |

### Sockets

|         |                                     |     |         |
|---------|-------------------------------------|-----|---------|
| 6500 09 | 240 V, 20 A, 2P+E<br>With blue cap  | 303 | 1/5/100 |
| 6500 29 | 240 V, 20 A, 2P+E<br>With ivory cap | 303 | 1/5/100 |
| 6500 11 | 440 V, 20 A, 3P+E<br>With red cap   | 407 | 1/5/100 |
| 6500 17 | 440 V, 32 A, 3P+E<br>With red cap   | 685 | 1/5/100 |

Bold Cat.Nos are products normally available with Legrand (India) Stockists. Cat.Nos that are not bold - delivery within 4 - 8 weeks from the date of order. Bold packing quantity is our mandatory packing. Orders to be placed by Legrand (India) Stockist in multiples of the same.

## Warranty policy

Legrand warrants to the original purchaser that the Products (excluding any third party products purchased through Legrand, for which no warranties are made) will be free from defects in material and workmanship, under normal use and regular service, and preventative maintenance for a period of 18 months from the date of shipment or 12 months from the date of installation whichever is earlier. Should any failure to conform with this warranty be found during the Warranty Period, you must notify Legrand of your claim within thirty (30) days of discovery, and within the Warranty Period. Your failure to give notice of claims of breach of warranty within the Warranty Period shall be deemed an absolute and unconditional waiver of claims for such defects. Legrand will have no responsibility to honour claims received after the date the applicable Warranty Period expires. The invoice / bill in original must be produced without which warranty claim shall not be entertained.

### **This warranty does not cover the following:**

- Defect caused due to misuse, alteration, faulty installation, faulty electrical systems, negligent maintenance or misapplication of the product.
- Failure of product or components due to any act of nature; lightning strike, floods, hurricanes, tornadoes, etc. beyond the control of human being.
- Legrand does not warrant any third party products or associated hardware or their performance or suitability for use and application. Such items are provided "as-is".

### **Extended warranty policy is applicable for following products,**

1. DX<sup>3</sup> & RX<sup>3</sup> MCB – 5 years if mounted inside Legrand DB
2. Arteor™ Advance, Arteor™, Myrius™, Myrius™ Regular, Mylinc™, Lyncus™, Allzy™, Britzy™ switches (without neon lamp) & Power sockets – 10 years
3. Arteor™ Advance, Arteor™, Myrius™, Myrius™ Regular, Mylinc™, Lyncus™, Allzy™, Britzy™ other products – 2 years



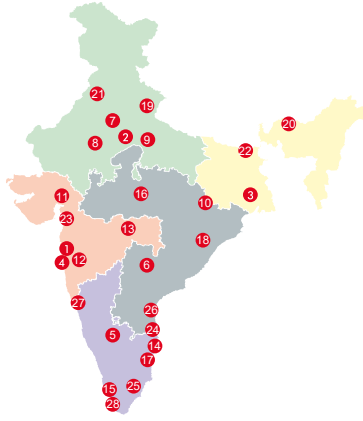

## Branch offices

7. Bestech Business Tower  
Unit no. 203, 2nd floor  
Tower -B, Sector -66,  
**MOHALI** - 160 062  
Tel.: (0172) 5019 008/ 4635 145 [INNOVAL](#)
8. 128, Mohan Nagar besides  
Ridhi Siddhi Flyover, **JAIPUR** - 302019  
Tel.: 0141-220 8665 [INNOVAL](#)
9. 209-A, 2<sup>nd</sup> Floor, Cyber Heights,  
Opp. Indira Gandhi Pratishthan,  
Vibhuti Khand, Gomti Nagar,  
**LUCKNOW** - 226 010.  
Tel.: (0522) 457 5427 [INNOVAL](#)
10. 202 & 203, Sunrise, Forum 100,  
Burdwan Compound, Lalpur,  
**RANCHI** - 834 001.  
Tel.: (651) 660 5400
11. A 101-102, Mondeal Heights,  
Besides Novotel Hotel, Sarkhej  
Gandhinagar Highway (S G Highway),  
**AHMEDABAD** - 380 015.  
Tel.: (079) 6134 0555 [INNOVAL](#)
12. 8<sup>th</sup> Floor, Pinnacle Park Avenue,  
Opp. Law College, Law College Road  
Next To German Bakery,  
Shivaji Nagar, **PUNE** - 411004.  
Tel.: (020) 6729 5601 / 600 [INNOVAL](#)
13. Plot No.95, 2<sup>nd</sup> Floor, Shreyash  
Heights, VIP Road, Ramdaspath,  
**NAGPUR** - 440 010.  
Tel.: (0712) 2440 900
14. 10 B, Prestige Center Court, Office Block,  
Vijaya Forum Mall, #183,N.S.K. Salai,  
Vadapalani, **CHENNAI** - 600 026.  
Tel.: (044) 6612 2800 [INNOVAL](#)
15. J. B. Manjooran Estate,  
Door No. 37/3484, 3<sup>rd</sup> Floor,  
Bye Pass Junction, Edappally,  
**COCHIN** - 682 024.  
Tel.: (0484) 2801921/6604700 [INNOVAL](#)
16. 204-205, Megapolis Square,  
579, M G Road,  
**INDORE** - 452 001.  
Tel.: (0731) 49998 91/92/93
17. MF-2, Datta's Lords House,  
Jamma Chettu Street, Mogalrajapuram,  
**VIJAYAWADA** - 520 010.  
Tel.: (0866) 2482393/6393
18. Plot No. 359, Saheed Nagar,  
2<sup>nd</sup> Floor,  
**BHUBANESWAR** - 751 007.  
Tel.: (0674) 2540 623
19. Unit - 1 & 2, Vijay Park,  
Main Chakrata Road,  
**DEHRADUN**- 248 001.  
Uttarakhand.  
Tel.: (0135) 661 6100 [INNOVAL](#)
20. House No. 97, Ground Floor,  
Rajgarh Main Road,  
Opp. City Heart Nursing Home,  
**GUWAHATI** - 781 007.

## Head offices

1. 61 & 62, 6<sup>th</sup> Floor,  
Kalpataru Square, Kondivita Road,  
Off Andheri-Kurla Road, Andheri (E),  
**MUMBAI** - 400 059.  
Tel.: (022) 3041 6200  
Fax : (022) 3041 6201  
Website : [www.legrand.co.in](http://www.legrand.co.in)

## Regional sales offices

2. B-225, 4<sup>th</sup> Floor, Okhla Industrial  
Area, Phase -1,  
**NEW DELHI** - 110020.  
Tel.: (011) 3990 2200 [INNOVAL](#)
3. Ecocenter Ambuja Neotia,  
Block - EM-04, 12<sup>th</sup> Floor,  
Unit - 1203, Sector - V, Salt Lake,  
**KOLKATA** - 700 091.  
Tel.: (033) 4021 3535 / 3536 [INNOVAL](#)
4. C/203, Corporate Avenue, Atul Projects,  
Near Mirador Hotel, Chakala,  
Andheri - Ghatkopar Link Road,  
Andheri - (E), **MUMBAI** - 400 099.  
Tel.: (022) 6230 1000 [INNOVAL](#)
5. Ferozes Manor, 1<sup>st</sup> Floor, No. 58,  
Bowring Hospital Road,  
**BANGALORE** - 560 001.  
Tel.: (080) 80682 20000 [INNOVAL](#)
6. Prestige Phoenix, 1<sup>st</sup> Floor,  
Survey number 199,  
Door No. 6-3-1219/J/101 & 102,  
Begumpet, **HYDERABAD**,  
Telangana - 500 016  
Tel.: (040) 4567 1717/2341 4398/234 14367 [INNOVAL](#)

## Area offices

21. SCO 50-51, 2<sup>nd</sup> Floor Lodhi Club  
Road Shaheed Bhagat Singh  
Nagar, **LUDHIANA** - 141 013.  
Tel.: (0161) 463 8439 [INNOVAL](#)
22. 94, Udhm Singh Sarani,  
Ground Floor, Ashrampara,  
**SILIGURI** - 734 001.  
Tel.: (353) 264 1067
23. A-207, Universal Business  
Center, Near Madhwan Circle,  
L.P. Savani Road, Adajan,  
**SURAT** - 395 009.  
Tel.: (0261) 263 3861 [INNOVAL](#)
24. Aparna Towers, 1<sup>st</sup> Floor, 2/3,  
Bypass Road,  
**MADURAI** - 625 010.  
Telefax : (0452) 230 8414
25. 43-9-205, 3<sup>rd</sup> Floor, Plot No. 10,  
Subbalakshmi Nagar,  
Opp. More Super Market,  
**VISAKHAPATNAM** - 530 016.  
Tel.: (0891) 273 5652/9363 [INNOVAL](#)
26. B-5, 1<sup>st</sup> Floor, Thirumalai Towers,  
723, Avanashi Road,  
**COIMBATORE** - 641 018.  
Tel.: (0422) 668 3200/222 3634 [INNOVAL](#)
27. 515 & 516, Gera Imperium Grand,  
Patto centre ,  
Panaji **GOA** - 403 001 [INNOVAL](#)
28. TC 25/3254/6, 1st Floor, Cordial Bharathi  
Nanthancodu, **Thiruvanthapuram**,  
KERALA- 695 003  
Tel.: (0471) 354 5052/353 8935 [INNOVAL](#)
29. 2<sup>nd</sup> Floor, GND Chambers,  
Agrasen Chowk, Samta Colony,  
Raipur - 492001, **Chattisgarh**  
Tel.: (0771) 4052 400

## Technical assistance from Legrand

Telephonic technical assistance for selection of products, technical information, guidance, wiring diagrams and estimation is now made available to you at each Regional Office. Contact the Technical Officer of Legrand at the following telephone numbers

**New Delhi** : Tel.: (011) 3990 2200  
**Kolkata** : Tel.: (033) 4021 3535  
**Mumbai** : Tel.: (022) 6230 1000  
**Chennai** : Tel.: (044) 6612 2800  
**Hyderabad** : Tel.: (040) 4567 1717

For other places, contact the nearest  
Regional / Branch / Area offices

[customer.care@legrand.co.in](mailto:customer.care@legrand.co.in)

