

# PANEL BUILDER PRICELIST 2026

Expanding Horizons,  
Together.



# Smart Innovation: Around The World

Legrand Group is a global specialist in electrical and digital building infrastructure, offering smart solutions across the residential, commercial, hospitality, and industrial sectors. This strong capability has positioned Legrand as the preferred choice of discerning customers in nearly 180 countries worldwide.

Our purpose is to improve lives by transforming the spaces where people live, work and meet by delivering electrical and digital infrastructures and connected solutions that are simple, innovative and sustainable.

Guided by its philosophy of “Listen, Design, Make, and Support”, Legrand closely tracks evolving lifestyles and customer needs. The Group designs high value-added products that seamlessly integrate advanced technology, ergonomic excellence, and refined aesthetics. Through smart ideas, sleek designs, and intuitive simplicity, Legrand aims to help every customer experience a simpler, better quality of life.

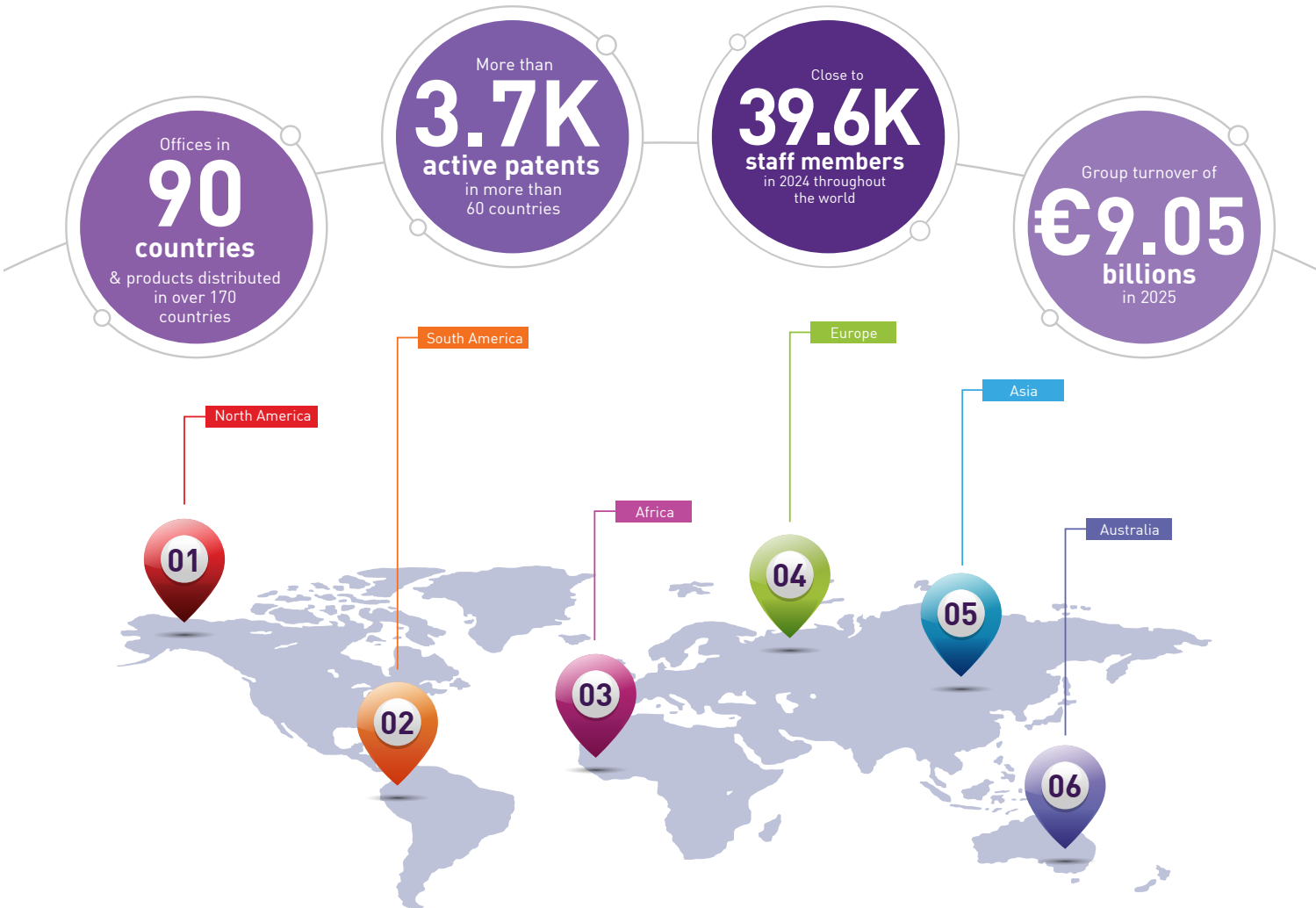

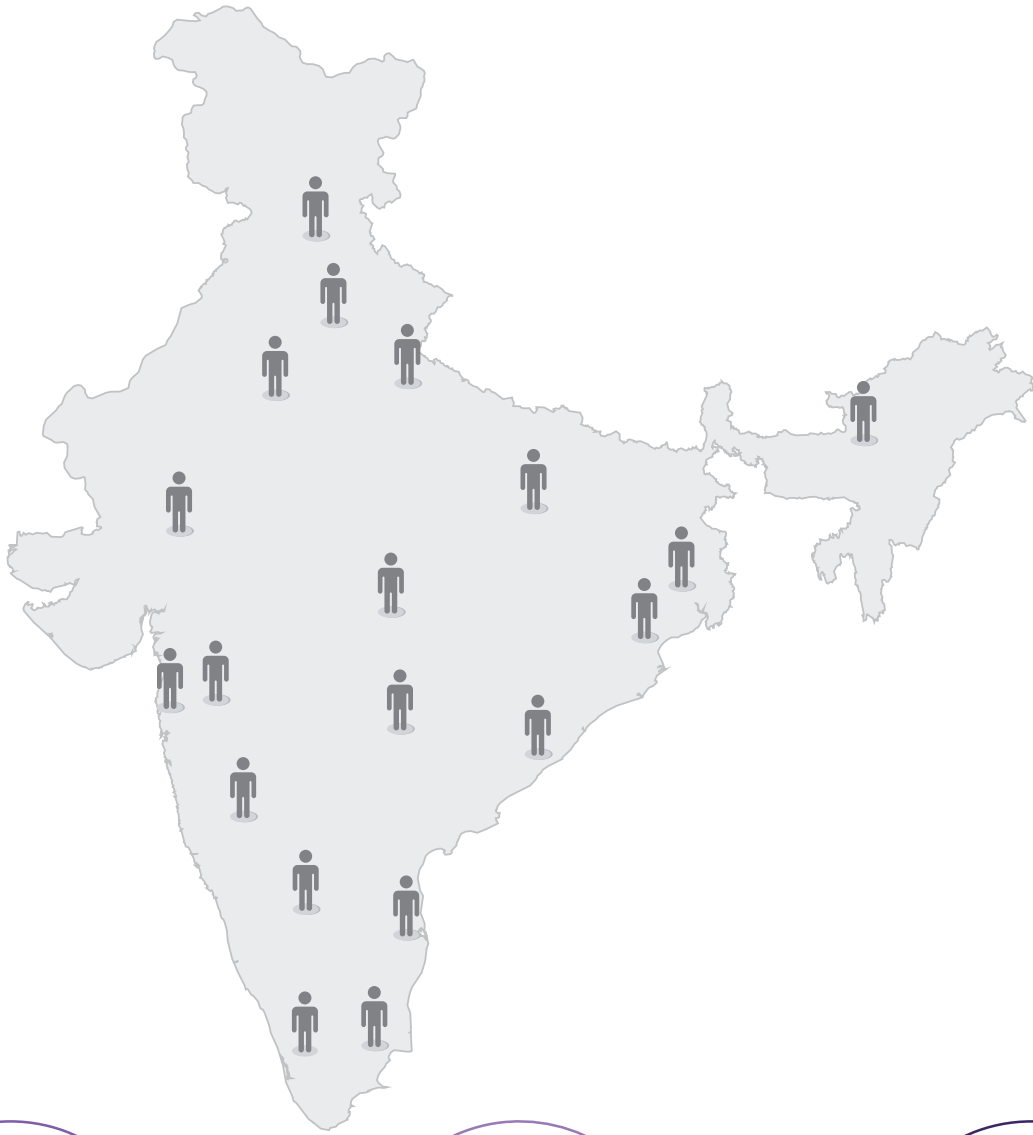

**91+ OFFICES**  
spread across  
the country

**OVER 5000+**  
**EMPLOYEES**  
in India

**07**  
**MANUFACTURING**  
facilities

**3**  
**R&D**  
centers

**22**  
**INNOVALS**  
& **3 CENTERS OF**  
**EXCELLENCE**

---

An extensive network of over **870**  
distribution partners and **18000** retailers

# The Global Specialist

A comprehensive solution for your Electrical and Digital Building Infrastructure.

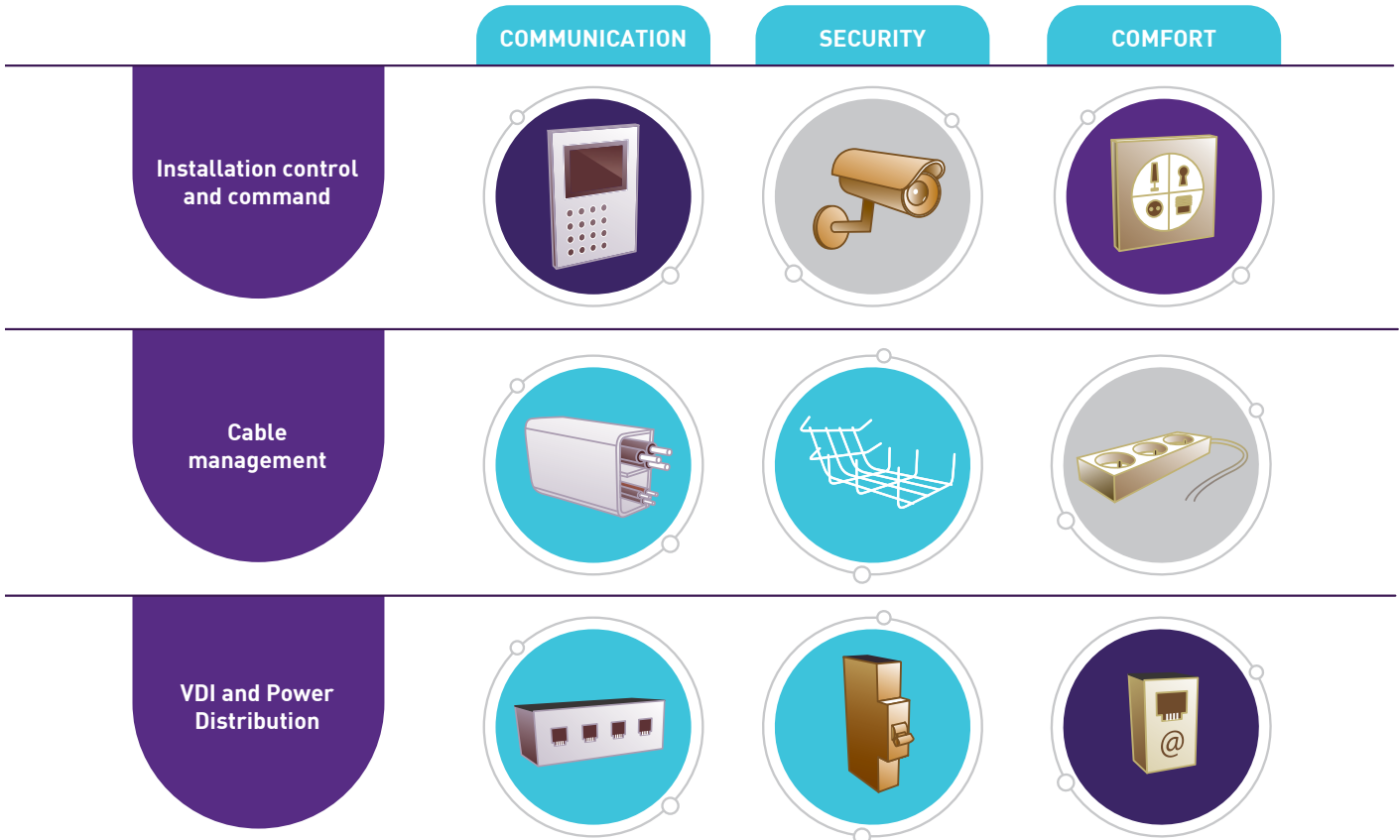

## Global Specialist in Electrical and Digital Building Infrastructure

Legrand is a global specialist in electrical and digital building infrastructures, delivering solutions for homes, data centers, commercial, healthcare, hospitality, and industrial spaces. With nearly 300,000 product references, Legrand holds No. 1 or No. 2 positions in most markets worldwide.

## Continuous Innovation

Over 2200 people work at our engineering and design offices, innovating simple and sustainable solutions.

## Product Design – A lever for differentiation

Design is integral to our overall strategy and lies at the core of everything we do at Legrand. More than aesthetics alone, design is about enhancing the overall customer experience.

# A Landmark Infrastructure Built with Purpose, Rooted in Trust



A massive infrastructure spanning 30000+ sqm, one of the largest factories for Legrand worldwide and India, was inaugurated recently at Nashik, Maharashtra. This factory assumes great significance not just for its investments and massive scale but also for its growth lever placing India at the centre of the Group's ambitions. The factory will soon be a certified green building by IGBC, with a 1 MW roof top solar installation and has been thoughtfully designed, keeping sustainability at the core of its planning.

## PRODUCTS:

Our new Nashik factory is designed to manufacture Bus Bar Trunking Systems (BBTS), Distribution Boards (DBs), Server Racks, Cablofil and Industrial plugs and sockets. The factory is all set to supply products both to the local market and for export, with shipments of BBTs and industrial plug and sockets already reaching international destinations. Plans are in place to expand exports to include DBs and Cablofil products, positioning our India factory as a global supply hub with significant capacity and agility.



# Our Values to Improve Lives

---



## WE SEIZE THE FUTURE

We seize the future by creating lasting, high performance solutions for every kind of building, driven by the vision and talent of our teams



## WE EMBRACE INCLUSION

We embrace inclusion by welcoming diversity among our customers, our people, and our partners, and turning it into a strength and opportunity



## WE MOVE IN SYNC

We grow stronger together - collaborating with people, brands, and partners to shape a connected and future-ready electrical ecosystem



## WE STRIVE FOR SIMPLICITY

We turn challenges into opportunities, creating purposeful innovations that deliver real value across every corner of the electrical sector



## WE ARE DEPENDABLE

We are dependable, guided by reliability and sustainability. For over 150 years, we've built trust through responsible design and ethical relationships with our customers

# Our Commitment to Sustainability

---



At Legrand, sustainability is a key consideration in our product development process.

Every product is crafted with a "**Eco Design**" approach, blending innovation with eco-friendly practices right from the start.

Our Product Environmental Profile (PEP) offers clear and reliable insights into the environmental impact of our products. By supporting green building initiatives and promoting eco-conscious choices, we ensure every product plays a role in building a more sustainable future.



# A Landmark Infrastructure Built with Purpose, Rooted in Trust

---

## Community Initiatives

---

### Legrand Empowering Scholarship

Program Started in 2018, this initiative supports meritorious girl students from lower socio-economic backgrounds in Engineering, Architecture, Science, and Technology. To date, over 700+ students have been enrolled, including 66 differently abled and 25 LGBTQ+ students.

Annually, more than 100 new scholarships are awarded. Additionally, each year over 50 students receive mentorship assistance from Legrand Subject Matter Experts, till date over 150 students have been mentored to be the Future Women Leaders.



### Legrand Telemedicine Center

Through our 3 centres located in Jalgaon, Haridwar, and Rohad, we offer free consultations, tests, and medicines in partnership with Apollo Hospitals. This initiative benefits over 10,000 community members annually and has positively impacted more than 72000 lives to date.

## Center of Excellence - Mathura, Dehradun & Bangalore

The centers at Mathura, ITI Niranjanpur, Dehradun & Bangalore aim to provide advanced training in Electrical & UPS systems. These centers focus on enhancing students' skills and improving their job opportunities. Over 168 ITI students have been trained and over 10 have been placed as service engineers in our company.



## Beach Clean-Up

Legrand adopted four beaches in Mumbai. This initiative aims to remove plastic waste and recycle it. Since September 2023, through the collective efforts of over 13992 volunteers, more than 134676 kg / 134.6 T of plastic has been collected and recycled into ten benches which were further donated to public spaces and schools.



## Water Table Recharge

Legrand has recharged over 100 community borewells in rural and tribal areas using a patented technology that recharges 15–20 lakh litres of groundwater annually, directly providing clean water access to more than 5,000 individuals.



# Intelligent EI

SMARTNESS THAT  
MAKES A DIFFERENCE

- Advanced Protection Intelligence
- Real-time Monitoring & Metering
- Event & Fault Data Logging
- Communication Ready
- User Access Control (Password Protection)

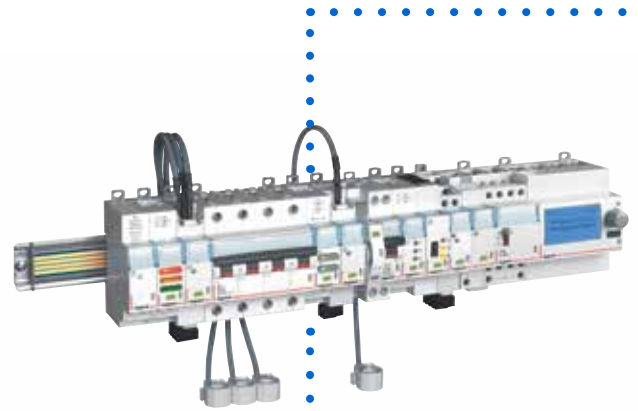

**PROGRAMMING  
AND DISPLAY**



**COMMUNICATION**



**MEASUREMENT**



**SIGNALLING**



**CONTROL**



Scan to know more about  
the product.



**SIGNALLING  
AND CONTROL**



# CX<sup>3</sup>

## A Smart Platform For Your Energy Management Needs

- Smart & Connected Ready
- Compact & Modular Design
- Versatile Load Control



**WEB SERVER**



**ACBs**



**MCCB'S**



**MEASURING  
UNIT**



**WATER**



**GAS**



Scan to know more about the product.



**BMS/SCADA**

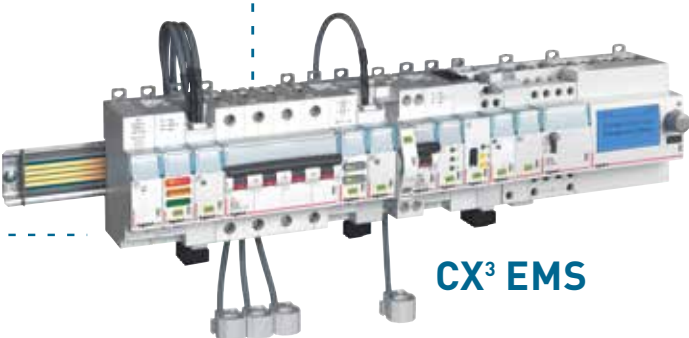

**CX<sup>3</sup> EMS**



**ENERGY  
METER**



**ELECTRICITY**

# DMX<sup>3</sup>

## Air Circuit Breakers

### Smarter Protection for Critical Power Systems



Scan to know more about the product.



## DMX<sup>3</sup> Air Circuit Breakers

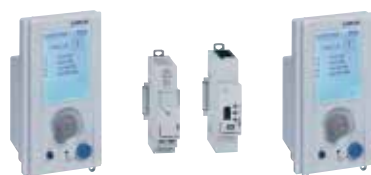

- Range – 630 A to 6300 A
- Three Optimum Frame Sizes
- Breaking Capacities of 50 kA, 65 kA & 100 kA
- Advanced Self Powered Electronic Protection Units
- MP4.10 and MP4.10M LCD Protection Units
- Long time delay protection against overloads I<sub>r</sub> from 0.2 to 1 x I<sub>n</sub> with (Steps 1A) - OFF
- Long delay protection operation time t<sub>r</sub> = 40 ms + 30 s (step 40)
- Short time delay protection against short-circuits I<sub>sd</sub> from 1,5I<sub>r</sub> to 10 I<sub>r</sub> with - OFF (step 1A)
- Short time delay protection operation time (t=k, I<sub>2</sub>t=k) t<sub>sd</sub> = 40 ms + 1 s (steps 40 ms)
- Instantaneous protection against very high short-circuits I<sub>i</sub> from 2 to 15 I<sub>n</sub> - OFF (step 1A)
- Earth fault current I<sub>g</sub> from 0.2 + 1 I<sub>n</sub> - OFF (step 0.1I<sub>n</sub>)
- Time delay on earth fault tripping (t=k, I<sub>2</sub>t=k) t<sub>g</sub> from 80 ms + 1s with (step 40 ms)
- Neutral protection I<sub>N</sub> = 50% - 100% - 150% - 200% - OFF
- Communication Capable
- In Built Temperature Protection
- Rotatable Terminals for Horizontal/Vertical Orientation<sup>(\*)</sup>
- Fast Operation
- Options to install various safety interlock
- Internal Battery for Trip Units
- Individual fault diagnosis
- Individual Fault Counter & Historical Trip Record
- Option to Measure Current, Voltage, Frequency, Power, Energy, Individual Harmonics, THD, Power Factor and internal battery voltage
- Switchable Thermal Memory

DMX <sup>3</sup>	1	08	N	4	E	D	4N
↓	↓	↓	↓	↓	↓	↓	↓
CB Series	Frame	Rating	BC	No. of Poles	Type of Spring Charging	Type of Mechanism	Type of Release
DMX3= DMX <sup>3</sup>	1=DMX <sup>3</sup> 2500 2=DMX <sup>3</sup> 4000	06=630A 08=800A 10=1000A 12=1250A 16=1600A 20=2000A 25=2500A 32=3200A 40=4000A	N=50kA H=65kA L=100kA	3=3Pole 4=4Pole	M=Manual Type  E=Electrical with 240V AC ECD+CC & 240V AC S/T	F=Fixed D=Drawout	00=Trip Free 4N=MP4.10 LSIG 4M=MP4.10 LSIG with Measurement

Type and frame size	Rated Current (A)	3P			4P		
		Cat.Nos	MRP*/₹/Unit	Pack	Cat.Nos	MRP*/₹/Unit	Pack

### Manual Fixed Version With MP4.10 PU

DMX <sup>3</sup> - N 2500, Icu 50 kA Frame - 1	630 A	DMX3106N3MF4N	■	1	DMX3106N4MF4N	■	1
	800 A	DMX3108N3MF4N	■	1	DMX3108N4MF4N	■	1
	1000 A	DMX3110N3MF4N	■	1	DMX3110N4MF4N	■	1
	1250 A	DMX3112N3MF4N	■	1	DMX3112N4MF4N	■	1
	1600 A	DMX3116N3MF4N	■	1	DMX3116N4MF4N	■	1
	2000 A	DMX3120N3MF4N	■	1	DMX3120N4MF4N	■	1
	2500 A	DMX3125N3MF4N	■	1	DMX3125N4MF4N	■	1
DMX <sup>3</sup> -N 4000 Icu 50 kA Frame - 2	3200 A	DMX3232N3MF4N	■	1	DMX3232N4MF4N	■	1
	4000 A	DMX3240N3MF4N	■	1	DMX3240N4MF4N	■	1
DMX <sup>3</sup> - H 2500, Icu 65 kA Frame - 1	630 A	DMX3106H3MF4N	■	1	DMX3106H4MF4N	■	1
	800 A	DMX3108H3MF4N	■	1	DMX3108H4MF4N	■	1
	1000 A	DMX3110H3MF4N	■	1	DMX3110H4MF4N	■	1
	1250 A	DMX3112H3MF4N	■	1	DMX3112H4MF4N	■	1
	1600 A	DMX3116H3MF4N	■	1	DMX3116H4MF4N	■	1
	2000 A	DMX3120H3MF4N	■	1	DMX3120H4MF4N	■	1
2500 A	DMX3125H3MF4N	■	1	DMX3125H4MF4N	■	1	



DMX3240L4MF4N

■ Price available on request.

\* MRP - Maximum Retail Price Inclusive of all taxes including GST.

<sup>(\*)</sup>Built in bothside rotatable terminals up to 1600A as a standard offer.

Bold Cat.Nos are products normally available with Legrand (India) Stockists. Cat.Nos that are not bold - delivery within 4 - 8 weeks from the date of order. Bold packing quantity is our mandatory packing. Orders to be placed by Legrand (India) Stockist in multiples of the same.

## DMX<sup>3</sup>

### Air Circuit Breakers

Type and frame size	Rated Current (A)	3P			4P		
		Cat.Nos	MRP*/₹/Unit	Pack	Cat.Nos	MRP*/₹/Unit	Pack

#### Manual Fixed Version with MP4.10 PU

DMX <sup>3</sup> - H 4000 Icu 65KA Frame 2	3200 A	DMX3232H3MF4N	■	1	DMX3232H4MF4N	■	1
	4000 A	DMX3240H3MF4N	■	1	DMX3240H4MF4N	■	1
DMX <sup>3</sup> - L 2500 Icu 100KA Frame 2	630 A	DMX3206L3MF4N	■	1	DMX3206L4MF4N	■	1
	800 A	DMX3208L3MF4N	■	1	DMX3208L4MF4N	■	1
	1000 A	DMX3210L3MF4N	■	1	DMX3210L4MF4N	■	1
	1250 A	DMX3212L3MF4N	■	1	DMX3212L4MF4N	■	1
	1600 A	DMX3216L3MF4N	■	1	DMX3216L4MF4N	■	1
	2000 A	DMX3220L3MF4N	■	1	DMX3220L4MF4N	■	1
	2500 A	DMX3225L3MF4N	■	1	DMX3225L4MF4N	■	1
DMX <sup>3</sup> - L 4000 Icu 100KA Frame 2	3200 A	DMX3232L3MF4N	■	1	DMX3232L4MF4N	■	1
	4000 A	DMX3240L3MF4N	■	1	DMX3240L4MF4N	■	1
DMX <sup>3</sup> - L 6300 Icu 100KA Frame 3	5000 A	0284 80	■	1	0284 82	■	1
	6300 A	0284 81	■	1	0284 83	■	1

#### Manual Drawout Version with MP 4.10 PU



DMX3108N3MD4N

DMX <sup>3</sup> - N 2500 Icu 50KA Frame 1	630 A	DMX3106N3MD4N	■	1	DMX3106N4MD4N	■	1
	800 A	DMX3108N3MD4N	■	1	DMX3108N4MD4N	■	1
	1000 A	DMX3110N3MD4N	■	1	DMX3110N4MD4N	■	1
	1250 A	DMX3112N3MD4N	■	1	DMX3112N4MD4N	■	1
	1600 A	DMX3116N3MD4N	■	1	DMX3116N4MD4N	■	1
	2000 A	DMX3120N3MD4N	■	1	DMX3120N4MD4N	■	1
	2500 A	DMX3125N3MD4N	■	1	DMX3125N4MD4N	■	1
DMX <sup>3</sup> - N 4000 Icu 50KA Frame 2	3200 A	DMX3232N3MD4N	■	1	DMX3232N4MD4N	■	1
	4000 A	DMX3240N3MD4N	■	1	DMX3240N4MD4N	■	1
DMX <sup>3</sup> - H 2500 Icu 65KA Frame 1	630 A	DMX3106H3MD4N	■	1	DMX3106H4MD4N	■	1
	800 A	DMX3108H3MD4N	■	1	DMX3108H4MD4N	■	1
	1000 A	DMX3110H3MD4N	■	1	DMX3110H4MD4N	■	1
	1250 A	DMX3112H3MD4N	■	1	DMX3112H4MD4N	■	1
	1600 A	DMX3116H3MD4N	■	1	DMX3116H4MD4N	■	1
	2000 A	DMX3120H3MD4N	■	1	DMX3120H4MD4N	■	1
	2500 A	DMX3125H3MD4N	■	1	DMX3125H4MD4N	■	1
DMX <sup>3</sup> - H 4000 Icu 65KA Frame 2	3200 A	DMX3232H3MD4N	■	1	DMX3232H4MD4N	■	1
	4000 A	DMX3240H3MD4N	■	1	DMX3240H4MD4N	■	1
DMX <sup>3</sup> - L 2500 Icu 100KA Frame 2	630 A	DMX3206L3MD4N	■	1	DMX3206L4MD4N	■	1
	800 A	DMX3208L3MD4N	■	1	DMX3208L4MD4N	■	1
	1000 A	DMX3210L3MD4N	■	1	DMX3210L4MD4N	■	1
	1250 A	DMX3212L3MD4N	■	1	DMX3212L4MD4N	■	1
	1600 A	DMX3216L3MD4N	■	1	DMX3216L4MD4N	■	1
	2000 A	DMX3220L3MD4N	■	1	DMX3220L4MD4N	■	1
	2500 A	DMX3225L3MD4N	■	1	DMX3225L4MD4N	■	1
DMX <sup>3</sup> - L 4000 Icu 100KA Frame 2	3200 A	DMX3232L3MD4N	■	1	DMX3232L4MD4N	■	1
	4000 A	DMX3240L3MD4N	■	1	DMX3240L4MD4N	■	1
DMX <sup>3</sup> - L 6300 Icu 100KA Frame 3	5000 A	0284 85	■	1	0284 87	■	1
	6300 A	0284 86	■	1	0284 88	■	1

\* MRP - Maximum Retail Price Inclusive of all taxes including GST.  
■ Price available on request.

Bold Cat.Nos are products normally available with Legrand (India) Stockists.  
Cat.Nos that are not bold - delivery within 4 - 8 weeks from the date of order.  
Bold packing quantity is our mandatory packing. Orders to be placed by Legrand (India) Stockist in multiples of the same.

## DMX<sup>3</sup>

### Electronic Protection Units

Type and frame size	Rated Current (A)	3P			4P		
		Cat.Nos	MRP*/₹/Unit	Pack	Cat.Nos	MRP*/₹/Unit	Pack

#### Electrical Fixed Version with MP4.10 PU with 240V AC, ECD+CC & 240V AC S/T

DMX <sup>3</sup> - N 2500 Icu 50KA Frame 1	630 A	DMX3106N3EF4N	■	1	DMX3106N4EF4N	■	1
	800 A	DMX3108N3EF4N	■	1	DMX3108N4EF4N	■	1
	1000 A	DMX3110N3EF4N	■	1	DMX3110N4EF4N	■	1
	1250 A	DMX3112N3EF4N	■	1	DMX3112N4EF4N	■	1
	1600 A	DMX3116N3EF4N	■	1	DMX3116N4EF4N	■	1
	2000 A	DMX3120N3EF4N	■	1	DMX3120N4EF4N	■	1
	2500 A	DMX3125N3EF4N	■	1	DMX3125N4EF4N	■	1
DMX <sup>3</sup> - N 4000 Icu 50KA Frame 2	3200 A	DMX3232N3EF4N	■	1	DMX3232N4EF4N	■	1
	4000 A	DMX3240N3EF4N	■	1	DMX3240N4EF4N	■	1
DMX <sup>3</sup> - H 2500 Icu 65KA Frame 1	630 A	DMX3106H3EF4N	■	1	DMX3106H4EF4N	■	1
	800 A	DMX3108H3EF4N	■	1	DMX3108H4EF4N	■	1
	1000 A	DMX3110H3EF4N	■	1	DMX3110H4EF4N	■	1
	1250 A	DMX3112H3EF4N	■	1	DMX3112H4EF4N	■	1
	1600 A	DMX3116H3EF4N	■	1	DMX3116H4EF4N	■	1
	2000 A	DMX3120H3EF4N	■	1	DMX3120H4EF4N	■	1
	2500 A	DMX3125H3EF4N	■	1	DMX3125H4EF4N	■	1
DMX <sup>3</sup> - H 4000 Icu 65KA Frame 2	3200 A	DMX3232H3EF4N	■	1	DMX3232H4EF4N	■	1
	4000 A	DMX3240H3EF4N	■	1	DMX3240H4EF4N	■	1
DMX <sup>3</sup> - L 2500 Icu 100KA Frame 2	630 A	DMX3206L3EF4N	■	1	DMX3206L4EF4N	■	1
	800 A	DMX3208L3EF4N	■	1	DMX3208L4EF4N	■	1
	1000 A	DMX3210L3EF4N	■	1	DMX3210L4EF4N	■	1
	1250 A	DMX3212L3EF4N	■	1	DMX3212L4EF4N	■	1
	1600 A	DMX3216L3EF4N	■	1	DMX3216L4EF4N	■	1
	2000 A	DMX3220L3EF4N	■	1	DMX3220L4EF4N	■	1
	2500 A	DMX3225L3EF4N	■	1	DMX3225L4EF4N	■	1
DMX <sup>3</sup> - L 4000 Icu 100KA Frame 2	3200 A	DMX3232L3EF4N	■	1	DMX3232L4EF4N	■	1
	4000 A	DMX3240L3EF4N	■	1	DMX3240L4EF4N	■	1

#### Electrical Drawout Version with MP 4.10 PU with 240V AC, ECD+CC & 240V AC S/T

DMX <sup>3</sup> - N 2500 Icu 50KA Frame 1	630 A	DMX3106N3ED4N	■	1	DMX3106N4ED4N	■	1
	800 A	DMX3108N3ED4N	■	1	DMX3108N4ED4N	■	1
	1000 A	DMX3110N3ED4N	■	1	DMX3110N4ED4N	■	1
	1250 A	DMX3112N3ED4N	■	1	DMX3112N4ED4N	■	1
	1600 A	DMX3116N3ED4N	■	1	DMX3116N4ED4N	■	1
	2000 A	DMX3120N3ED4N	■	1	DMX3120N4ED4N	■	1
	2500 A	DMX3125N3ED4N	■	1	DMX3125N4ED4N	■	1
DMX <sup>3</sup> - N 4000 Icu 50KA Frame 2	3200 A	DMX3232N3ED4N	■	1	DMX3232N4ED4N	■	1
	4000 A	DMX3240N3ED4N	■	1	DMX3240N4ED4N	■	1



DMX3112N3ED4N

\* MRP - Maximum Retail Price Inclusive of all taxes including GST.  
■ Price available on request.

Bold Cat.Nos are products normally available with Legrand (India) Stockists. Cat.Nos that are not bold - delivery within 4 - 8 weeks from the date of order. Bold packing quantity is our mandatory packing. Orders to be placed by Legrand (India) Stockist in multiples of the same.

## DMX<sup>3</sup> Air Circuit Breakers

Type and frame size	Rated Current (A)	3P			4P		
		Cat.Nos	MRP*/₹/Unit	Pack	Cat.Nos	MRP*/₹/Unit	Pack

### Electrical Drawout Version with MP 4.10 PU with 240V AC, ECD+CC & 240V AC S/T

DMX <sup>3</sup> - H 2500 Icu 65KA Frame 1	630 A	DMX3106H3ED4N	■	1	DMX3106H4ED4N	■	1
	800 A	DMX3108H3ED4N	■	1	DMX3108H4ED4N	■	1
	1000 A	DMX3110H3ED4N	■	1	DMX3110H4ED4N	■	1
	1250 A	DMX3112H3ED4N	■	1	DMX3112H4ED4N	■	1
	1600 A	DMX3116H3ED4N	■	1	DMX3116H4ED4N	■	1
	2000 A	DMX3120H3ED4N	■	1	DMX3120H4ED4N	■	1
	2500 A	DMX3125H3ED4N	■	1	DMX3125H4ED4N	■	1
DMX <sup>3</sup> - H 4000 Icu 65KA Frame 2	3200 A	DMX3232H3ED4N	■	1	DMX3232H4ED4N	■	1
	4000 A	DMX3240H3ED4N	■	1	DMX3240H4ED4N	■	1
DMX <sup>3</sup> - L 2500 Icu 100KA Frame 2	630 A	DMX3206L3ED4N	■	1	DMX3206L4ED4N	■	1
	800 A	DMX3208L3ED4N	■	1	DMX3208L4ED4N	■	1
	1000 A	DMX3210L3ED4N	■	1	DMX3210L4ED4N	■	1
	1250 A	DMX3212L3ED4N	■	1	DMX3212L4ED4N	■	1
	1600 A	DMX3216L3ED4N	■	1	DMX3216L4ED4N	■	1
	2000 A	DMX3220L3ED4N	■	1	DMX3220L4ED4N	■	1
	2500 A	DMX3225L3ED4N	■	1	DMX3225L4ED4N	■	1
DMX <sup>3</sup> - L 4000 Icu 100KA Frame 2	3200 A	DMX3232L3ED4N	■	1	DMX3232L4ED4N	■	1
	4000 A	DMX3240L3ED4N	■	1	DMX3240L4ED4N	■	1

### Switch Disconnecter (Trip Free Switches) From 1250 To 6300A Manual Fixed Version

DMX <sup>3</sup> - I 2500 Frame 1	1250 A	DMX3112S3MF00	■	1	DMX3112S4MF00	■	1
	1600 A	DMX3116S3MF00	■	1	DMX3116S4MF00	■	1
	2000 A	DMX3120S3MF00	■	1	DMX3120S4MF00	■	1
	2500 A	DMX3125S3MF00	■	1	DMX3125S4MF00	■	1
DMX <sup>3</sup> -I 4000 Frame 2	3200 A	DMX3232S3MF00	■	1	DMX3232S4MF00	■	1
	4000 A	DMX3240S3MF00	■	1	DMX3240S4MF00	■	1
DMX <sup>3</sup> - L 4000 Icu 100KA Frame 2	6300 A	0282 88	■	1	0282 89	■	1

### Manual Drawout Version

DMX <sup>3</sup> - I 2500 Frame 1	1250 A	DMX3112S3MD00	■	1	DMX3112S4MD00	■	1
	1600 A	DMX3116S3MD00	■	1	DMX3116S4MD00	■	1
	2000 A	DMX3120S3MD00	■	1	DMX3120S4MD00	■	1
	2500 A	DMX3125S3MD00	■	1	DMX3125S4MD00	■	1
DMX <sup>3</sup> -I 4000 Frame 2	3200 A	DMX3232S3MD00	■	1	DMX3232S4MD00	■	1
	4000 A	DMX3240S3MD00	■	1	DMX3240S4MD00	■	1
DMX <sup>3</sup> -I-6300 Frame 3	6300 A	0282 98	■	1	0282 99	■	1

\* MRP - Maximum Retail Price Inclusive of all taxes including GST.  
■ Price available on request.

- Note - 1. For Voltages other than 220 - 250 V AC and DC, please order MF/MDO ACB and the required Voltage accessories  
2. For Frame 3 ACB, consider Individual Internal and External Accessories as per requirement.  
3. For EF and EDO versions of Switch-disconnectors, please contact Sales office.

Bold Cat.Nos are products normally available with Legrand (India) Stockists. Cat.Nos that are not bold - delivery within 4 - 8 weeks from the date of order. Bold packing quantity is our mandatory packing. Orders to be placed by Legrand (India) Stockist in multiples of the same.



DMX3120S3MD00

## DMX<sup>3</sup>

### Air Circuit Breakers

Cat.Nos	Description	MRP*/₹/Unit	Pack
---------	-------------	-------------	------

#### Electronic Protection Units MP4.10

0283 06	<b>MP4.10</b> Protection Unit with rotating encoder for Adjustment of Ir,tr,isd,tsd,li,Ig and tg Possibility to enable/disable protections With Current Measurement and LCD display protection conditions Fault signaling and log	■	1
---------	---	---	---



0283 06

#### Electronic Protection Units MP4.10M

0283 07	<b>MP4.10M</b> Protection Unit with rotating encoder for Adjustment via rotating encoder Adjustment of Ir,tr,isd,tsd,li,Ig and tg Possibility to enable/disable protections With Current, Voltage, Frequency Power, Energy Measurement, individual harmonics, THD and LCD display with instantaneous, maximum and average values of different electrical values and protection conditions Fault signaling and log	■	1
---------	---	---	---



0283 07

Type and frame size	3P			4P		
	Cat.Nos	MRP*/₹/Unit	Pack	Cat.Nos	MRP*/₹/Unit	Pack

#### Fixed Version

DMX <sup>3</sup> 2500, fixed version, frame - 1	0288 84	■	1	0288 85	■	1
	0288 82	■	1	0288 83	■	1
DMX <sup>3</sup> 4000, DMX <sup>3</sup> 6300 fixed version, frame - 2 & 3	0288 92	■	1	0288 93	■	1
DMX <sup>3</sup> 2500 draw-out version, Frame - 1	0288 96	■	1	0288 97	■	1
DMX <sup>3</sup> 4000, DMX <sup>3</sup> 6300 draw-out version, fram - 2 & 3	0288 94	■	1	0288 95	■	1
DMX <sup>3</sup> 2500, draw-out version, frame-1 suitable for Aluminium	0288 96A	■	1	0288 97A	■	1
DMX <sup>3</sup> 4000, DMX <sup>3</sup> 6300 draw-out version, frame - 2&3, suitable for Aluminium	0288 94A	■	1	0288 95A	■	1



0288 84



0288 82



0288 96

#### Spreaders/Terminal Adaptors

DMX <sup>3</sup> 2500, fixed version, frame - 1	0289 02	■	1	0288 87	■	1
	0288 88	■	1	0288 89	■	1
	0288 90	■	1	0288 91	■	1

0288 91

#### Equipment For Conversion Of A Fixed Device Into Draw-Out Device

##### Bases (Cradle) For Draw-Out Device

DMX <sup>3</sup> /DMX <sup>3</sup> -I 2500, frame - 1	0289 02	■	1	0289 03	■	1
---	---------	---	---	---------	---	---

\* MRP - Maximum Retail Price Inclusive of all taxes including GST.

■ Price available on request.

Red Cat. Nos - New Products

For External Neutral Sensors for DMX3 ACB, please contact sales office.

Bold Cat.Nos are products normally available with Legrand (India) Stockists. Cat.Nos that are not bold - delivery within 4 - 8 weeks from the date of order. Bold packing quantity is our mandatory packing. Orders to be placed by Legrand (India) Stockist in multiples of the same.

## DMX<sup>3</sup>

### Air Circuit Breakers

Equipment For Conversion Of A Fixed Device Into Draw-Out Device

#### Bases (Cradle) For Draw-Out Device

DMX <sup>3</sup> /DMX <sup>3</sup> -I 4000, frame - 2	0289 04	■	1	0289 05	■	1
DMX <sup>3</sup> /DMX <sup>3</sup> -I 6300, frame - 3	0289 13	■	1	0289 14	■	1

#### Transformation kit for Draw-Out Version

DMX <sup>3</sup> /DMX <sup>3</sup> -I 2500, frame - 1	0289 09	■	1	0289 10	■	1
DMX <sup>3</sup> /DMX <sup>3</sup> -I 4000, frame - 2	0289 11	■	1	0289 12	■	1
DMX <sup>3</sup> /DMX <sup>3</sup> -I 6300, frame - 3	0289 15	■	1	0289 16	■	1

## DMX<sup>3</sup>

### Auxiliaries and Accessories

Cat.Nos	Description	MRP* ₹ / Unit	Pack
---------	-------------	------------------	------

#### Control and Signalling Auxiliaries

##### Shunt Trip

0288 48	24 V $\sim$ /=	■	1
0288 49	48 V $\sim$ /=	■	1
0288 50	110 V $\sim$ /=	■	1
0288 51	230 V $\sim$ /=	■	1
0288 52	415 V $\sim$	■	1



0288 51

##### Undervoltage Releases

0288 55	24 V $\sim$ /=	■	1
0288 56	48 V $\sim$ /=	■	1
0288 57	110 V $\sim$ /=	■	1
0288 58	230 V $\sim$ /=	■	1
0288 59	415 V $\sim$	■	1



0288 58

## DMX<sup>3</sup>

### Auxiliaries and Accessories

Cat.Nos	Description	MRP* ₹ / Unit	Pack
---------	-------------	------------------	------

#### Undervoltage Releases With Delay

0288 62	110 V $\sim$ /=	■	1
0288 63	230 V $\sim$ /=	■	1

#### Motor Operators

0288 34	24 V $\sim$ /=	■	1
0288 35	48 V $\sim$ /=	■	1
0288 36	110 V $\sim$ /=	■	1
0288 37	230 V $\sim$ /=	■	1
0288 38	415 V $\sim$	■	1



0288 37

#### Closing Coils

0288 41	24 V $\sim$ /=	■	1
0288 42	48 V $\sim$ /=	■	1
0288 43	110 V $\sim$ /=	■	1
0288 44	230 V $\sim$ /=	■	1
0288 45	415 V $\sim$ /=	■	1



0288 44

\* MRP - Maximum Retail Price Inclusive of all taxes including GST.  
■ Price available on request.

Bold Cat.Nos are products normally available with Legrand (India) Stockists. Cat.Nos that are not bold - delivery within 4 - 8 weeks from the date of order. Bold packing quantity is our mandatory packing. Orders to be placed by Legrand (India) Stockist in multiples of the same.

## DMX<sup>3</sup>

### Auxiliaries and Accessories

Cat.Nos	Description	MRP* ₹ / Unit	Pack
---------	-------------	------------------	------

#### Locking

##### Key Locking In "Open" Position

0288 27	Open position lock RONIS x 5 + 3 keys (Random)	■	1
0288 28	2 hole support frame for RONIS locks	■	1
4238 80	Key barrel and flat key with random mapping	■	1
4238 81	Key barrel and flat key with fixed mapping	■	1
4238 82	Key barrel and flat key with fixed mapping	■	1
4238 83	Key barrel and star key with random mapping	■	1
0281 94	Kit for key lock in d/o position DMX3	■	1

#### Locking

##### Key locking in the draw out position

4238 80	Key Lock (Only lock + key)	■	1
4238 83	Key barrel and star key with random mapping	■	1
0281 94	Kit for key lock in d/o position DMX3	■	1

#### Door locking

0288 20	Left-hand and right-hand side mounting	■	1
---------	--	---	---

#### Padlocks In "Open" Position

0288 21	Padlocking system for ACB	■	1
0288 24	Padlocking for button	■	1
0288 26	Padlocking system for shutters	■	1

\* MRP - Maximum Retail Price Inclusive of all taxes including GST.  
 ■ Price available on request.

## DMX<sup>3</sup>

### Auxiliaries and Accessories

Cat.Nos	Description	MRP* ₹ / Unit	Pack
---------	-------------	------------------	------

#### Automation control unit

4226 81	Standard unit	■	1
4226 82	Advanced unit	■	1
4226 89	Communication module	■	1



4226 82



0288 64

#### Equipment For Supply Invertors

0288 64	Interlock for DMX <sup>3</sup> 2500	■	1
0288 65	Interlock for DMX <sup>3</sup> 4000	■	1
0288 66	Interlock for DMX <sup>3</sup> 6300	■	1

#### Cable Interlock

0289 20	Type 1 (2600 mm)	■	1
0289 21	Type 2 (3000 mm)	■	1
0289 22	Type 3 (3600 mm)	■	1
0289 23	Type 4 (4000 mm)	■	1
0289 24	Type 5 (4600 mm)	■	1
0289 25	Type 6 (5600 mm)	■	1

#### Accessories

0288 25	Rating mis-insertion device	■	1
0288 23	Operations counter	■	1
0288 13	Inserted / test / Draw-out Contact	■	1
0288 14	Contact "ready to close" with charged springs	■	1
0288 15	Set of additional signalling contacts	■	1
0288 16	Signal Contact for Auxiliaries	■	1
0288 22	Door sealing IP 40	■	1
0288 79	Lifting plate	■	1

Bold Cat.Nos are products normally available with Legrand (India) Stockists. Cat.Nos that are not bold - delivery within 4 - 8 weeks from the date of order. Bold packing quantity is our mandatory packing. Orders to be placed by Legrand (India) Stockist in multiples of the same.

# e-COMMUNICATION ARCHITECTURE

## PROTECTION

## MEASUREMENT

## CONTROL AND SIGNALLING

### RESIDENTIAL

DX<sup>3</sup> Ph+N MCBs



4086 14      4085 90

EMDX<sup>3</sup> energy meters



4120 45      4120 81      4120 91



4062 95      4062 52      0261 36

Auxiliaries and motorised control + I/O interface

### COLLECTIVE HOUSING AND SMALL OFFICE BUILDINGS

DX<sup>3</sup> MCBs



4086 14      4085 90

EMDX<sup>3</sup> measuring units



4120 53

EMDX<sup>3</sup> energy meters



4120 45 / 4120 81 / 4120 91

Earth Leakage Module with integrated Measurement



4106 57

CX3 EMS signaling and control modules



4149 29 / 4149 30 / 4149 32

CX<sup>3</sup> + DX<sup>3</sup> MCBs



4086 94      4125 56

Cx<sup>3</sup> EMS modules:

4149 19 Single phase



4149 26 Pulse concentrator



4149 20 Three phase



CX3 EMS signaling and control modules



4149 31

### COMMERCIAL AND INDUSTRIAL

4234 28



DPX<sup>3</sup> MCCBs



DMX3216L3ED4N

DMX<sup>3</sup> ACB

EMDX<sup>3</sup> measuring units



4120 53

EMDX<sup>3</sup> energy meters



4120 45 / 4120 91

Auxiliaries and motorised control + I/O interface



0288 15      0261 44      0261 36

CX<sup>3</sup> EMS measuring module



4149 23

Auxiliaries and motorised controls



0288 15      0261 44

Electronic DPX<sup>3</sup> with integrated measurement



0283 07

DMX<sup>3</sup> with electronic Protection unit



+ CX3 EMS signalling and control modules



4149 29 / 4149 32

COMMUNICATION

REMOTE

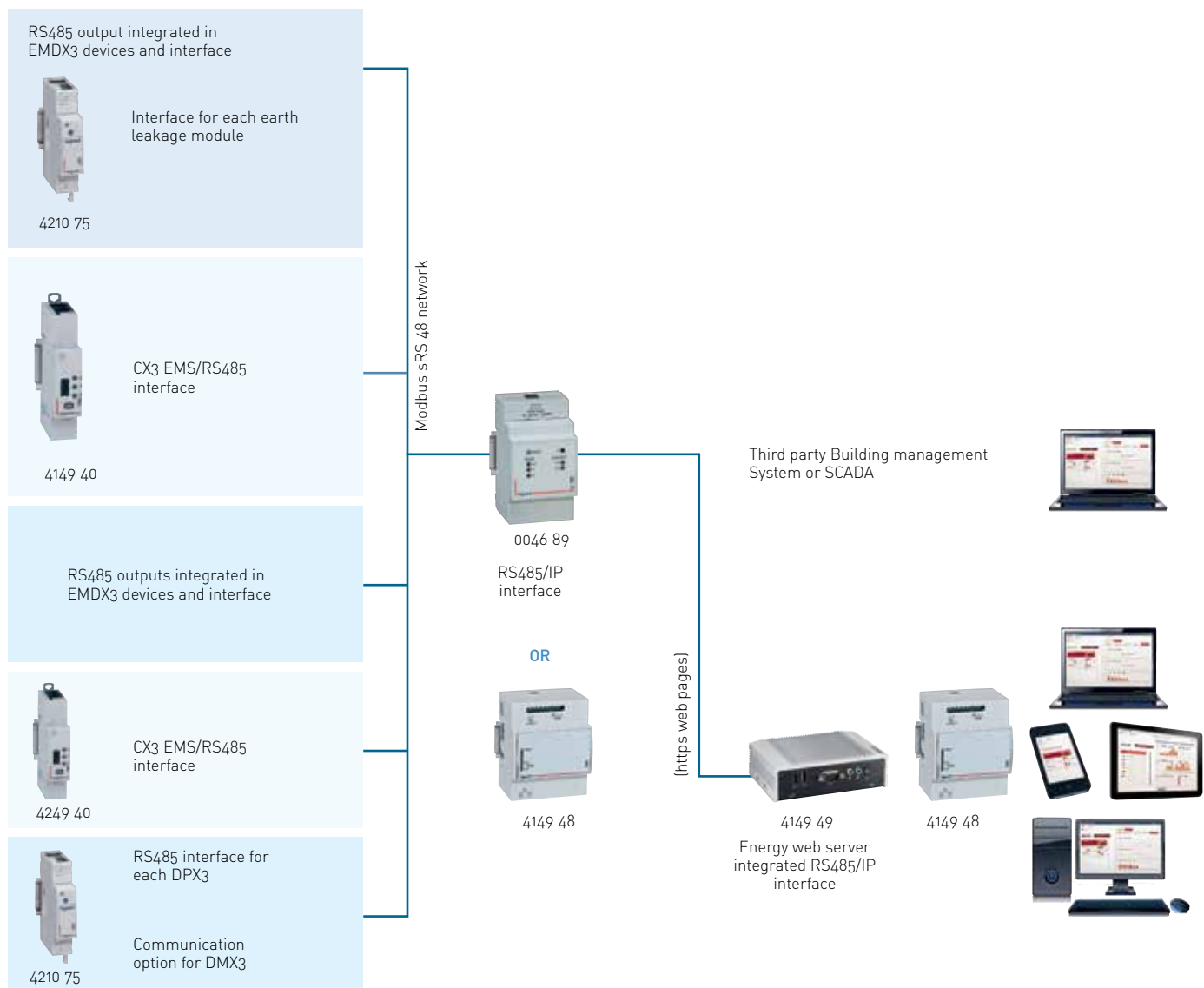

## e-Communicating Infrastructure

Cat.Nos	Description	MRP* ₹ / Unit	Pack
---------	-------------	------------------	------

### Power Supervision System

#### Control, Monitoring And Measurement

#### Communication Accessories For ACB

4149 45	EMS CX <sup>3</sup> Power Supply 230/12VDC	12870	1
4149 40	EMS CX <sup>3</sup> / RS485 Gateway	15220	1
4149 07	EMS CX <sup>3</sup> 10 Patch Cords 250MM	9500	10
4149 08	EMS CX <sup>3</sup> 10 Patch Cords 500MM	13690	10
4149 09	EMS CX <sup>3</sup> 5 Patch Cords 1000MM	10900	5
4149 10	EMS CX <sup>3</sup> 5 Patch Cord Connector	3820	5

#### Communication Modules

#### Signalling and Control Interface

##### Features

Signalling and control interface between the power supervision system and the **thermal magnetic or electronic circuit breakers**.

Equipped with analogue / digital inputs and relay outputs.

Can handle multiple circuit breakers.

**24 inputs for collecting information** from the signalling auxiliaries on the DPX<sup>3</sup> and DMX<sup>3</sup> circuit breakers: auxiliary contact NO position (1 input) or NO+NC position (2 inputs), fault signal (1 input)

**6 outputs for: the remote control of the motor driven circuit breakers** (2 outputs) and for tripping the circuit breakers (1 output)

Communication is ensured by the Modbus protocol. Address, speed and coding can be modified with

#### Configuration Kit.

0261 36	Sign. & Comm. Interface	38300	1
---------	-------------------------	-------	---

#### Communication Accessories for MCCB

##### Features

RS485 communication interface

**Potential free contact for circuit breaker tripped status information max. 220 V 0.2 A**

4210 75	DPX <sup>3</sup> Communication Interface	23510	1
4210 83	Input Voltage 24 V (2MOD)	6550	1

\* MRP - Maximum Retail Price Inclusive of all taxes including GST.

■ Price available on request.

Red Cat. Nos - New Products

## e-Communicating Infrastructure

Cat.Nos	Description	MRP* ₹ / Unit	Pack
---------	-------------	------------------	------

### Communication Accessories For MCB

#### Features

RS485 communication interface

**Potential free contact for circuit breaker tripped status information max. 220 V 0.2 A**

Can be connected with DX3 add on Modules (4106 57/58/59)

4210 75	DPX <sup>3</sup> Communication Interface	23510	1
---------	--	-------	---

#### Communication Accessories

0261 45	BUS Plug-In Jumpers Kit - 0 to 9 Marking (10 of each)	■	1
0046 89	IP Converter RS485/ Ethernet AC	66590	1
1466 23	Stabilised Sw Mod Powrsup75 960	21944	1

#### Energy management multi-support web servers

Allow remote configuration, test, control and visualization, via a web browser on PCs, smartphones, web viewers, tablet computers, of data Converter

##### Features

#### In-built IP converter

Power supply: 9 to 28 V= with the help of a single-phase switching mode power supply Cat.No 1467 21 to be ordered separately. With the Legrand Power supervision system, circuit breakers are integrated in a supervision system

You can therefore check the status of the circuit breakers, measure the electrical values and control the circuit breakers remotely.

#### MODBUS protocol

4149 47	Mini Energy WS - 10	135660	1
4149 48	Web Server for 32 Meters	194952	1
4149 49	Web Server for Unlimited	■	1

Bold Cat.Nos are products normally available with Legrand (India) Stockists. Cat.Nos that are not bold - delivery within 4 - 8 weeks from the date of order. Bold packing quantity is our mandatory packing. Orders to be placed by Legrand (India) Stockist in multiples of the same.

# DMX-SP

## Air Circuit Breakers

### For Smart & Reliable Low Voltage Power Distribution



The DMX-SP range of air circuit breakers and trip-free switches offers reliable protection for standard electrical installations. Designed for performance and durability, the range supports current ratings up to 2500A and breaking capacities up to 50kA, ensuring safe and dependable operation across a wide range of applications

#### Features

- Powered with Advanced MP2.10 and MP4.10 Protection units
- With Integrated LED / LCD display
- Fixed and draw-out configurations
- Available as ACBs and trip-free switches

#### Benefits

- Rotatable Rear Terminals
- Provides flexible installation options to adapt to different switchboard designs
- Delivers reliable performance in demanding operational conditions
- Lower Power Losses (Energy Efficient)

Scan to know more about the product.



## DMX SP 2500 Air Circuit Breakers



- Range – 630 A to 2500 A
- Single Frame Size
  - Options of Fixed and Drawout Versions
  - Options of Manual & Electrical Versions
  - Icu=Ics=Icw(1s)=50 kA
  - Compact Dimensions
  - Advanced Self Powered Electronic Protection Units
    - MP2.10 and MP4.10
  - MP2.10 - Electronic PU with LED Display with LSIG + Neutral O/L + Over Temperature Protection + communication capable
  - MP4.10 - Electronic PU with LSIG + Neutral O/L + Over Temperature Protection + LCD Display with Current Metering + 20 Trip History + 20 Alarms + Logical Selectivity
  - Configurable LSING protection + communication capable
  - Long time delay protection against overloads I<sub>r</sub> from 0.2 to 1 x I<sub>n</sub> (Step 1A) – OFF
  - Long delay protection operation time t<sub>r</sub> = 40 ms + 30 s (step 40 ms)
  - Short time delay protection against short circuits I<sub>sd</sub> from 1.5I<sub>r</sub> to 10 I<sub>r</sub> – OFF (step 1A)
  - Short time delay protection operation time (t=k, I<sub>2</sub>t=k) t<sub>sd</sub> = 40 ms + 1 s (step 40 ms)
  - Instantaneous protection against very high short circuits I<sub>i</sub> from 2 to 15 I<sub>n</sub> – OFF (step 1A)
  - Earth fault current I<sub>g</sub> from 0.2 x I<sub>n</sub> – OFF (step 0.1I<sub>n</sub>)
  - Time delay on earth fault tripping (t=k, I<sub>2</sub>t=k) I<sub>g</sub> from 80 ms + 1s (step 40 ms)
  - Neutral protection I<sub>N</sub> = 50% – 100% – 150% – 200% – OFF
  - In Built Temperature Protection
  - Rotatable Terminals for Horizontal/Vertical Orientation<sup>(1)</sup>
  - Fast Operation
  - Options to install various safety interlock
  - Switchable Thermal Memory

DMXSP	1	08	N	4	E	D	2N
↓	↓	↓	↓	↓	↓	↓	↓
CB Series	Frame	Rating	BC	No. of Poles	Type of Spring Charging	Type of Mechanism	Type of Release
DMXS=DMX SP	1=DMX SP 2500	06=630A 08=800A 10=1000A 12=1250A 16=1600A 20=2000A 25=2500A	N=50kA	3=3Pole 4=4Pole	M=Manual Type E=Electrical with 240V AC ECD+CC & 240V AC S/T	F=Fixed D=Drawout	00=Trip Free 2N=MP2.10 LSIG 4N= MP4.10 LSIG

Type and frame size	Rated Current (A)	3P			4P		
		Cat.Nos	MRP*/₹/Unit	Pack	Cat.Nos	MRP*/₹/Unit	Pack

### Manual Fixed Version With MP2.10 PU

DMX-SP- N 2500 Icu 50KA	630 A	DMXS106N3MF2N	196330	1	DMXS106N4MF2N	256940	1
	800 A	DMXS108N3MF2N	196330	1	DMXS108N4MF2N	256940	1
	1000 A	DMXS110N3MF2N	207350	1	DMXS110N4MF2N	273480	1
	1250 A	DMXS112N3MF2N	237660	1	DMXS112N4MF2N	312040	1
	1600 A	DMXS116N3MF2N	269190	1	DMXS116N4MF2N	339490	1
	2000 A	DMXS120N3MF2N	314850	1	DMXS120N4MF2N	399390	1
	2500 A	DMXS125N3MF2N	386460	1	DMXS125N4MF2N	442310	1

### Manual Drawout Version With MP 2.10 PU

DMX-SP- N 2500 Icu 50KA Frame 1	630 A	DMXS106N3MD2N	240410	1	DMXS106N4MD2N	301010	1
	800 A	DMXS108N3MD2N	240410	1	DMXS108N4MD2N	301010	1
	1000 A	DMXS110N3MD2N	251440	1	DMXS110N4MD2N	317550	1
	1250 A	DMXS112N3MD2N	281730	1	DMXS112N4MD2N	356120	1
	1600 A	DMXS116N3MD2N	312440	1	DMXS116N4MD2N	382740	1
	2000 A	DMXS120N3MD2N	377350	1	DMXS120N4MD2N	440640	1
	2500 A	DMXS125N3MD2N	433000	1	DMXS125N4MD2N	507470	1

\*MRP - Maximum Retail Price Inclusive of all taxes including GST.  
<sup>(1)</sup>Built in bothside rotatable terminals up-to 1600A as a standard offer.

Bold Cat.Nos are products normally available with Legrand (India) Stockists.  
 Cat.Nos that are not bold - delivery within 4 - 8 weeks from the date of order.  
 Bold packing quantity is our mandatory packing. Orders to be placed by Legrand (India) Stockist in multiples of the same.



DMX112N3MD2N

## DMX SP 2500

### Air Circuit Breakers

Type and frame size	Rated Current (A)	3P			4P		
		Cat.Nos	MRP*/₹/Unit	Pack	Cat.Nos	MRP*/₹/Unit	Pack

#### Electrical Fixed Version With MP2.10 PU With 240V AC, ECD+CC & 240V AC S/T

DMX-SP- N 2500 Icu 50KA	630 A	DMXS106N3EF2N	261240	1	DMXS106N4EF2N	321850	1
	800 A	DMXS108N3EF2N	261240	1	DMXS108N4EF2N	321850	1
	1000 A	DMXS110N3EF2N	272260	1	DMXS110N4EF2N	338380	1
	1250 A	DMXS112N3EF2N	302560	1	DMXS112N4EF2N	376940	1
	1600 A	DMXS116N3EF2N	334080	1	DMXS116N4EF2N	404390	1
	2000 A	DMXS120N3EF2N	379750	1	DMXS120N4EF2N	464300	1
	2500 A	DMXS125N3EF2N	451360	1	DMXS125N4EF2N	507200	1

#### Electrical Drawout Version With MP 2.10 PU With 240V AC, ECD+CC & 240V AC S/T

DMX-SP- N 2500 Icu 50KA	630 A	DMXS106N3ED2N	305310	1	DMXS106N4ED2N	365910	1
	800 A	DMXS108N3ED2N	305310	1	DMXS108N4ED2N	365910	1
	1000 A	DMXS110N3ED2N	316350	1	DMXS110N4ED2N	382450	1
	1250 A	DMXS112N3ED2N	346640	1	DMXS112N4ED2N	421010	1
	1600 A	DMXS116N3ED2N	377350	1	DMXS116N4ED2N	447630	1
	2000 A	DMXS120N3ED2N	442240	1	DMXS120N4ED2N	505540	1
	2500 A	DMXS125N3ED2N	497910	1	DMXS125N4ED2N	572360	1

#### Manual Fixed Version With MP4.10 PU

DMX-SP- N 2500 Icu 50KA	630 A	DMXS106N3MF4N	212420	1	DMXS106N4MF4N	278020	1
	800 A	DMXS108N3MF4N	212420	1	DMXS108N4MF4N	278020	1
	1000 A	DMXS110N3MF4N	224350	1	DMXS110N4MF4N	295900	1
	1250 A	DMXS112N3MF4N	257140	1	DMXS112N4MF4N	344860	1
	1600 A	DMXS116N3MF4N	297500	1	DMXS116N4MF4N	375200	1
	2000 A	DMXS120N3MF4N	347960	1	DMXS120N4MF4N	432130	1
	2500 A	DMXS125N3MF4N	418140	1	DMXS125N4MF4N	478560	1



DMXS116N3MF4N

#### Manual Drawout Version With MP 4.10 PU

DMX-SP- N 2500 Icu 50KA	630 A	DMXS106N3MD4N	244940	1	DMXS106N4MD4N	325680	1
	800 A	DMXS108N3MD4N	244940	1	DMXS108N4MD4N	325680	1
	1000 A	DMXS110N3MD4N	256180	1	DMXS110N4MD4N	343570	1
	1250 A	DMXS112N3MD4N	287040	1	DMXS112N4MD4N	393560	1
	1600 A	DMXS116N3MD4N	322670	1	DMXS116N4MD4N	422990	1
	2000 A	DMXS120N3MD4N	389670	1	DMXS120N4MD4N	476760	1
	2500 A	DMXS125N3MD4N	441170	1	DMXS125N4MD4N	549070	1

#### Electrical Fixed Version With MP4.10 PU With 240V AC, ECD+CC & 240V AC S/T

DMX-SP- N 2500 Icu 50KA	630 A	DMXS106N3EF4N	282660	1	DMXS106N4EF4N	348230	1
	800 A	DMXS108N3EF4N	282660	1	DMXS108N4EF4N	348230	1
	1000 A	DMXS110N3EF4N	294560	1	DMXS110N4EF4N	366110	1
	1250 A	DMXS112N3EF4N	327360	1	DMXS112N4EF4N	416580	1
	1600 A	DMXS116N3EF4N	369220	1	DMXS116N4EF4N	446920	1
	2000 A	DMXS120N3EF4N	419690	1	DMXS120N4EF4N	513110	1
	2500 A	DMXS125N3EF4N	488360	1	DMXS125N4EF4N	548780	1

\* MRP - Maximum Retail Price Inclusive of all taxes including GST.

Bold Cat.Nos are products normally available with Legrand (India) Stockists. Cat.Nos that are not bold - delivery within 4 - 8 weeks from the date of order. Bold packing quantity is our mandatory packing. Orders to be placed by Legrand (India) Stockist in multiples of the same.

## DMX SP 2500

### Air Circuit Breakers

Type and frame size	Rated Current (A)	3P			4P		
		Cat.Nos	MRP*/₹/Unit	Pack	Cat.Nos	MRP*/₹/Unit	Pack

#### Electrical Drawout Version With MP 4.10 PU With 240V AC, ECD+CC & 240V AC S/T

DMX-SP- N 2500 Icu 50KA	630 A	DMXS106N3ED4N	330340	1	DMXS106N4ED4N	395900	1
	800 A	DMXS108N3ED4N	330340	1	DMXS108N4ED4N	395900	1
	1000 A	DMXS110N3ED4N	342280	1	DMXS110N4ED4N	413810	1
	1250 A	DMXS112N3ED4N	375060	1	DMXS112N4ED4N	465280	1
	1600 A	DMXS116N3ED4N	417020	1	DMXS116N4ED4N	494710	1
	2000 A	DMXS120N3ED4N	488760	1	DMXS120N4ED4N	558710	1
	2500 A	DMXS125N3ED4N	538720	1	DMXS125N4ED4N	619280	1

#### Switch Disconnector (Trip Free Switches) From 630 To 2500A Manual Fixed Version

DMX <sup>3</sup> - I 2500	630 A	DMXS106S3MF00	154260	1	DMXS106S4MF00	214870	1
	800 A	DMXS108S3MF00	154260	1	DMXS108S4MF00	214870	1
	1000 A	DMXS110S3MF00	165270	1	DMXS110S4MF00	231400	1
	1250 A	DMXS112S3MF00	195570	1	DMXS112S4MF00	269960	1
	1600 A	DMXS116S3MF00	227100	1	DMXS116S4MF00	297410	1
	2000 A	DMXS120S3MF00	271990	1	DMXS120S4MF00	357310	1
	2500 A	DMXS125S3MF00	344380	1	DMXS125S4MF00	400220	1

#### Manual Drawout Version

DMX <sup>3</sup> - I 2500	630 A	DMXS106S3MD00	198320	1	DMXS106S4MD00	258920	1
	800 A	DMXS108S3MD00	198320	1	DMXS108S4MD00	258920	1
	1000 A	DMXS110S3MD00	209350	1	DMXS110S4MD00	275460	1
	1250 A	DMXS112S3MD00	239660	1	DMXS112S4MD00	314030	1
	1600 A	DMXS116S3MD00	270360	1	DMXS116S4MD00	340650	1
	2000 A	DMXS120S3MD00	335260	1	DMXS120S4MD00	398560	1
	2500 A	DMXS125S3MD00	390920	1	DMXS125S4MD00	465380	1

\* MRP - Maximum Retail Price Inclusive of all taxes including GST.  
 Note - 1. For EF and EDO versions of Switch-disconnectors, please contact Sales office.  
 For Voltages other than 220 - 250 V AC and DC, please order MF/MDO ACB and the required Voltage accessories

Bold Cat.Nos are products normally available with Legrand (India) Stockists. Cat.Nos that are not bold - delivery within 4 - 8 weeks from the date of order. Bold packing quantity is our mandatory packing. Orders to be placed by Legrand (India) Stockist in multiples of the same.

## DMX SP 2500

### Electronic Protection Units

Cat.Nos	Description	MRP* ₹ / Unit	Pack
---------	-------------	------------------	------

#### Electronic protection units

0283 00	<b>MP2.10</b> Protection Unit with rotating encoder for Adjustmen of Ir, tr, isd, tsd, li, lg and tg Possibility to enable/disable protections With Current Measurement and LCD display protection conditions Fault signaling and log	42090	1
0283 02	<b>MP4.10</b> Protection Unit with rotating encoder for Adjustmen of Ir, tr, isd, tsd, li, lg and tg Possibility to enable/disable protections With Current Measurement and LCD display protection conditions Fault signaling and log	52480	1



0283 00



0283 02

#### Auxiliaries Accessories

##### Motor Operator

0281 20	Motor operator 24V AC/DC DMX S	48510	1
0281 21	Motor operator 48V AC/DC DMX S	48510	1
0281 22	Motor operator 110-130V AC/DC	48510	1
0281 23	Motor operator 220-250V AC/DC	48510	1
0281 24	Motor operator 415V - 440V ac	48510	1



0281 23

##### Closing Coil

0281 26	Closing coil 24V AC/DC DMX SP	8170	1
0281 27	Closing coil 48V AC/DC DMX SP	8170	1
0281 28	Closing coil 110-130V AC/DC DM	8170	1
0281 29	Closing coil 220-250V AC/DC DM	8170	1
0281 30	Closing coi 415-440V AC DMX S	8170	1



0281 29

##### Shunt Release

0281 31	Shunt trip 24V AC/DC DMX SP	8170	1
0281 32	Shunt trip 48V AC/DC DMX SP	8170	1
0281 33	Shunt trip 110-130V AC/DC DMX	8170	1
0281 34	Shunt trip 220-250V AC/DC DMX	8170	1
0281 35	Shunt trip 415-440V AC DMX SP	8170	1



0281 34

##### Undervoltage Release

0281 36	Undervoltage release 24V AC/DC	11040	1
0281 37	Undervoltage release 48V AC/DC	11040	1
0281 38	Undervoltage release 110-130V	11040	1
0281 39	Undervoltage release 220-250V	11040	1
0281 40	Undervoltage release 415-440V	11040	1



0281 39

■ Price available on request.

\* MRP - Maximum Retail Price Inclusive of all taxes including GST.

Red Cat. Nos - New Products

## DMX SP 2500

### Auxiliaries Accessories

Cat.Nos	Description	MRP* ₹ / Unit	Pack
---------	-------------	------------------	------

#### Time Delay Module For Undervoltage Release

0288 62	Undervolt Rel T Delay 110V AC/DC	■	1
0288 63	Undervolt Rel T Delay 230V AC/DC	9140	1

#### Mechanical Accessories

##### Phase Barriers / Insulated Shields

6696 00	Fix Version 3P DMX SP	■	1
6696 01	Fix Version 4P DMX SP	■	1
6696 02	Insulation shields Draw-out Ve	2810	1
6696 03	Insulation shields Draw-out Ve	3750	1



6696 00



6696 01

##### Key Lock Open & Drawout Position

0281 91	Key Lock In Open & D/O Posit	■	1
4238 80	Key barrel and flat key with random mapping	■	1
4238 81	Key barrel and flat key with fixed mapping	■	1
4238 82	Key barrel and flat key with fixed mapping	■	1
4238 83	Key barrel and star key with random mapping	■	1
0281 84	Door lock for both right&left	6840	1
0281 87	Safety button for test positio	3160	1

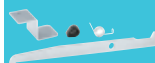

0281 84

##### Terminals

0288 84	Real terminals - flat connection	26720	1
0288 82	Real terminals - vertical connection	29690	1
0288 85	Real terminals - flat connection	34730	1
0288 83	Real terminals - vertical connection	40070	1
0288 96	Real terminals - vertical or horizontal	16150	1
0288 97	Real terminals - vertical or horizontal	21540	1

##### Additional Accessories

0281 88	Mechanical counter DMX SP	5260	1
0281 77	Padlock for button DMX SP	2090	1
6696 20	External Neutral DMX-SP 2500 M	23110	1
0281 73	Signalling contact inserted-tes	4120	1
0281 74	AUX ready to close-charged spr	4210	1
0281 75	Module with 6 aux contacts DMX	31560	1
0281 90	Mech Interlock two device	16870	1



0281 88



0281 75

Bold Cat.Nos are products normally available with Legrand (India) Stockists. Cat.Nos that are not bold - delivery within 4 - 8 weeks from the date of order. Bold packing quantity is our mandatory packing. Orders to be placed by Legrand (India) Stockist in multiples of the same.

**NEW!**

# 1000V Solution

## Smart Protection Renewable Energy installations

DMX<sup>3</sup> ACBs and DPX<sup>3</sup> MCCBs are engineered to deliver reliable 1000V AC protection for critical applications across renewable energy, wind power, and rail infrastructure. Designed for high-performance environments, they combine robust protection, compact integration, and intelligent monitoring to support efficient and future-ready power distribution systems.

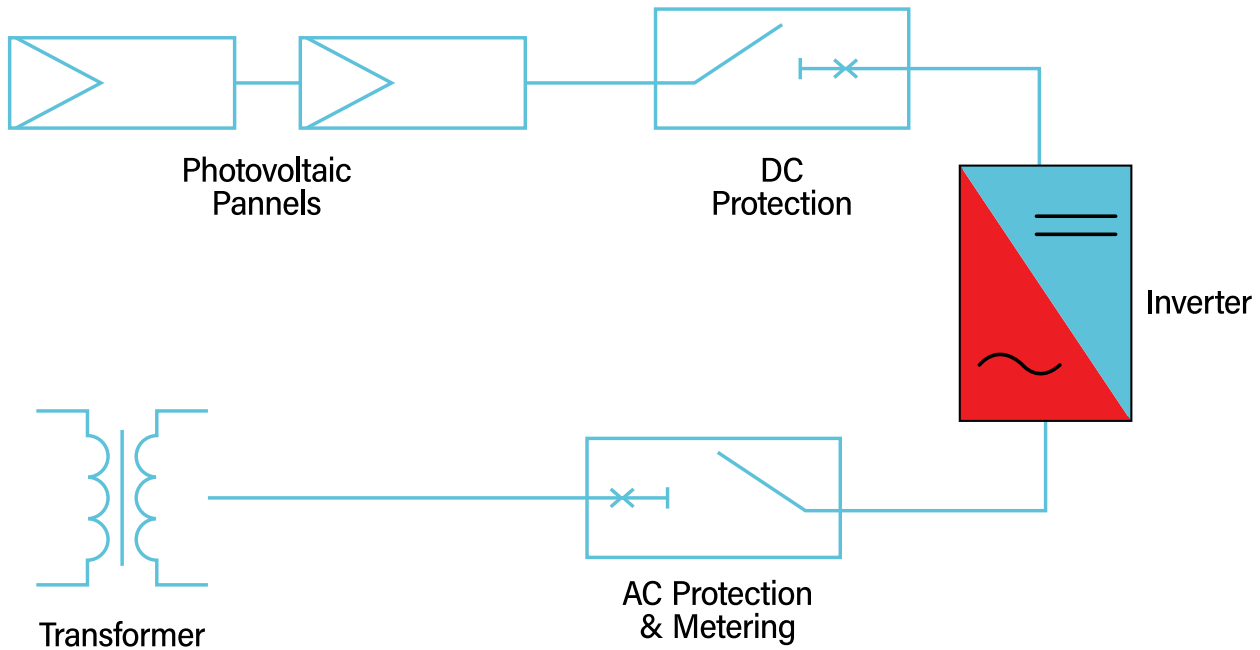

**DMX<sup>3</sup>**  
1000V ACB



**DPX<sup>3</sup>**  
1000V MCCB

# Application Areas

## Solar Power Plants



1000V DMX<sup>3</sup> ACBs provide reliable protection at main distribution and grid interface points, while DPX<sup>3</sup> MCCBs ensure efficient feeder and circuit protection across inverter outputs and distribution networks in large-scale photovoltaic installations.

## Wind Energy Systems

Scan to know more about the product.



Legrand 1000V DMX<sup>3</sup> ACBs deliver robust protection for turbine switchboards and main power distribution, while DPX<sup>3</sup> MCCBs support dependable feeder-level protection within nacelles and wind farm electrical systems.

**NEW!**

# DPX<sup>3</sup> MCCBs

For Smart & Reliable  
Low Voltage  
Power Distribution



## Key Highlights

- Thermal-magnetic and New Electronics protection trip unit- S1 & S10
- Zone Selective Interlocking with USB port and inbuilt LCD screen
- Customizable protection settings to match specific project power distribution requirements
- High breaking capacity up to 100 kA for dependable fault interruption
- Bluetooth connectivity for smartphone-based configuration and monitoring
- Connectivity with EMS and supervision systems for smarter energy management



# DPX<sup>3</sup> 630 and 1600

S1 and S10 protection units



DPX<sup>3</sup>630

DPX<sup>3</sup>1600

Scan to know more about  
the product.



**DPX<sup>3</sup> MCCB**  
**DPX<sup>3</sup> MCCB 125/160/250 HP**

Category	Type	Rated Current (A)	3P			4P		
			Cat.Nos	MRP*/₹/Unit	Pack	Cat.Nos	MRP*/₹/Unit	Pack

**Thermal Magnetic release -Fixed version**

36 KA	DPX <sup>3</sup> 125HP	16	423600	14730	1	423610	18390	1	
		25	423602	14730	1	423612	18390	1	
		40	423604	14730	1	423614	18390	1	
		63	423606	14730	1	423616	18390	1	
		80	423607	14730	1	423617	18390	1	
		100	423608	14730	1	423618	18390	1	
		125	423609	17270	1	423619	22540	1	
	DPX <sup>3</sup> 160HP	160	423720	21480	1	423721	25290	1	
	DPX <sup>3</sup> 250HP	200	423011	38070	1	423026	48130	1	
		250	423012	42230	1	423027	51530	1	
	50 KA	DPX <sup>3</sup> 125HP	16	423640	19620	1	423650	24730	1
			25	423642	19620	1	423652	24730	1
40			423644	19620	1	423654	24730	1	
63			423646	19620	1	423656	24730	1	
80			423647	19620	1	423657	24730	1	
100			423648	19620	1	423658	24730	1	
125			423649	25710	1	423659	29640	1	
DPX <sup>3</sup> 160HP		160	423725	27940	1	423726	32500	1	
DPX <sup>3</sup> 250HP		200	423071	46120	1	423086	58260	1	
		250	423072	48680	1	423087	60610	1	
DPX <sup>3</sup> 250HP		200	423131	62160	1	423146	76480	1	
		250	423132	66060	1	423147	79610	1	

**Thermal magnetic release with Electronic earth leakage module - Fixed version**

36 KA	DPX <sup>3</sup> 125HP	16	■	■	■	423630	68920	1
		25	■	■	■	423632	68920	1
		40	■	■	■	423634	68920	1
		63	■	■	■	423636	68920	1
		80	■	■	■	423637	68920	1
		100	■	■	■	423638	68920	1
		125	■	■	■	423639	69290	1
	DPX <sup>3</sup> 160HP	160	■	■	■	423723	79550	1
	DPX <sup>3</sup> 250HP	200	■	■	■	423056	87110	1
		250	■	■	■	423057	93150	1

■ Price available on request.

\* MRP - Maximum Retail Price inclusive of all taxes including GST.

Bold Cat.Nos are products normally available with Legrand (India) Stockists. Cat.Nos that are not bold - delivery within 4 - 8 weeks from the date of order. Bold packing quantity is our mandatory packing. Orders to be placed by Legrand (India) Stockist in multiples of the same.

## DPX<sup>3</sup> MCCB

### DPX<sup>3</sup> MCCB 125/160/250 HP

Category	Type	Rated Current (A)	3P			4P		
			Cat.Nos	MRP*/₹/Unit	Pack	Cat.Nos	MRP*/₹/Unit	Pack

#### Thermal magnetic release with Electronic earth leakage module - Fixed version

50 KA	DPX <sup>3</sup> 125HP	16	■	■	■	423670	77030	1
		25	■	■	■	423672	77030	1
		40	■	■	■	423674	77030	1
		63	■	■	■	423676	77030	1
		80	■	■	■	423677	77030	1
		100	■	■	■	423678	77030	1
		125	■	■	■	423679	85030	1
	DPX <sup>3</sup> 160HP	160	■	■	■	423728	85460	1
	DPX <sup>3</sup> 250HP	200	■	■	■	423116	104360	1
		250	■	■	■	423117	110880	1

#### Accessories of DPX<sup>3</sup> 125 HP, 160HP

Cat.Nos	Description	MRP* ₹ / Unit	Pack	Cat.Nos	Description	MRP* ₹ / Unit	Pack
423810	DPX <sup>3</sup> 125HP RH DIRECT STD	1810	1	421049	Padlock for locking in "open" position For DPX <sup>3</sup> 160/250 and DPX <sup>3</sup> 125/160/250 HP	■	1
423811	DPX <sup>3</sup> 125HP RH DIRECT EMERG	1970	1	423876	CAGE TERMINALS DPX <sup>3</sup> 125 HP(3P)	11050	1
423812	DPX <sup>3</sup> 125HP RH VARI DEPTH STD	2980	1	423877	CAGE TERMINALS DPX <sup>3</sup> 125 HP(4P)	14620	1
423813	DPX <sup>3</sup> 125HP RH VARI DEPTH EMERG	3230	1	423884	CAGE TERMINALS DPX <sup>3</sup> 125 HP(3P)	■	1
423805	DPX <sup>3</sup> 125&250HPKEYLOCK ACC VARI	3160	1	423885	CAGE TERMINALS DPX <sup>3</sup> 125 HP(4P)	■	1
423806	AUXILIARY CNT BLOCK 1N/C+1 N/O	2010	1	423888	3 LINKS SET FOR TP DRX125A EXP	1000	1
423825	Plate for mounting and interlocking of 2 DPX <sup>3</sup> 125/160 HP	■	1	423889	4 LINKS SET FOR FP DRX125A EXP	1350	1
423827	Interlocking mechanism for 2 fixed DPX <sup>3</sup> 125/160/250 HP MCCBs	■	1	423891	DPX <sup>3</sup> 125HP REAR TERMINALS 4P	6020	1
423828	Interlocking mechanism for 2 fixed DPX <sup>3</sup> 125/160/250 HP MCCBs with electronic module	■	1	423892	DPX <sup>3</sup> 125HP REAR TERMINALS 4P	8070	1
423834	Set of 2 insulated shields for DPX <sup>3</sup> 125/160/250 HP 3P	■	1	423893	SHIELDS FOR FRONT TERMINAL(HIG)	4150	1
423835	Set of 3 insulated shields for DPX <sup>3</sup> 125/160/250 HP 4P	■	1	423894	SHIELDS FOR FRONT TERMINAL(HIG)	3680	1

■ Price available on request.

\* MRP - Maximum Retail Price Inclusive of all taxes including GST.

Bold Cat.Nos are products normally available with Legrand (India) Stockists. Cat.Nos that are not bold - delivery within 4 - 8 weeks from the date of order. Bold packing quantity is our mandatory packing. Orders to be placed by Legrand (India) Stockist in multiples of the same.

## DPX<sup>3</sup> MCCB

### DPX<sup>3</sup> 250 HP MCCB with New Electronics S1 Protection Unit

- DPX<sup>3</sup> MCCB with electronic S1 (LSI) protection unit
- Configurable Protections with Enable and Disable possibility
  - Ics=100%Icu
  - Protection against Overloads:
    - Ir adjustable from OFF-0.4 to 1 x In
    - tr adjustable- 5s
  - Protection against Short Circuits:
    - Isd adjustable 1.5 to 10Ir
    - tsd - 100ms
  - Breaking Capacity – 36kA, 50kA, 70kA & 100kA

Category	Type	Rated Current (A)	3P			4P		
			Cat.Nos	MRP*/₹/Unit	Pack	Cat.Nos	MRP*/₹/Unit	Pack

#### Electronic S1 (LSI) Protection Unit

36 KA	DPX <sup>3</sup> 250HP	40	423200	■	1	423205	■	1
		100	423201	■	1	423206	■	1
		160	423202	■	1	423207	■	1
		250	423203	■	1	423208	■	1
50 KA	DPX <sup>3</sup> 250HP	40	423220	■	1	423225	■	1
		100	423221	■	1	423226	■	1
		160	423222	■	1	423227	■	1
		250	423223	■	1	423228	■	1
70 KA	DPX <sup>3</sup> 250HP	40	423240	■	1	423245	■	1
		100	423241	■	1	423246	■	1
		160	423242	■	1	423247	■	1
		250	423243	■	1	423248	■	1
100 KA	DPX <sup>3</sup> 250HP	40	423250	■	1	423255	■	1
		100	423251	■	1	423256	■	1
		160	423252	■	1	423257	■	1
		250	423253	■	1	423258	■	1

#### Electronic S1 (LSI) Protection Unit with Electronic earth leakage module - Fixed version

36 KA	DPX <sup>3</sup> 250HP	40	■	■	■	423215	■	1
		100	■	■	■	423216	■	1
		160	■	■	■	423217	■	1
		250	■	■	■	423218	■	1
50 KA	DPX <sup>3</sup> 250HP	40	■	■	■	423235	■	1
		100	■	■	■	423236	■	1
		160	■	■	■	423237	■	1
		250	■	■	■	423238	■	1

■ Price available on request.

\* MRP - Maximum Retail Price Inclusive of all taxes including GST.

Bold Cat.Nos are products normally available with Legrand (India) Stockists. Cat.Nos that are not bold - delivery within 4 - 8 weeks from the date of order. Bold packing quantity is our mandatory packing. Orders to be placed by Legrand (India) Stockist in multiples of the same.

## DPX<sup>3</sup> MCCB

### DPX<sup>3</sup> 250 HP MCCB with New Electronics S10 Protection Unit

- DPX<sup>3</sup> MCCB with electronic S10 (LSIg) & energy metering protection unit
- Configurable Protections with Enable and Disable possibility
  - Ics=100%Icu
  - Protection against Overloads:
    - Ir adjustable from OFF-0.2 to 1 x In
    - tr adjustable from 3 to 30s
  - Protection against Short Circuits:
    - Isd adjustable from OFF-1.5 to 10 x Ir
    - tsd adjustable from 0 to 0.5s
  - Inbuilt Instantaneous Protection: - li – Fixed and 2 to 15x In through PCS
  - Protection against Ground Fault:
    - Ig adjustable from 0.2 to 1 In & OFF
    - tg adjustable from 0.80ms to 1s
  - Protection against Neutral Fault: OFF-50% -100% -150% -200%
  - Breaking Capacity – 36kA, 50kA, 70kA & 100kA
  - Integrated energy metering with accuracy class 1
  - Measure for currents, voltage, frequency, power, energy, THD and Individual harmonics
  - Internal Battery with battery measure function
  - Communication ready
  - Logical Selectivity Ready (Zone Selective Interlocking)
  - In Built USB Port for Software Diagnosis
  - Switchable Thermal Memory
  - Suitable for Isolation

Category	Type	Rated Current (A)	3P			4P		
			Cat.Nos	MRP*/₹/Unit	Pack	Cat.Nos	MRP*/₹/Unit	Pack

#### Electronic S10 (LSIg) Protection Unit

36 KA	DPX <sup>3</sup> 250HP	40	423400	■	1	423405	■	1
		100	423401	■	1	423406	■	1
		160	423402	■	1	423407	■	1
		250	423403	■	1	423408	■	1
50 KA	DPX <sup>3</sup> 250HP	40	423420	■	1	423425	■	1
		100	423421	■	1	423426	■	1
		160	423422	■	1	423427	■	1
		250	423423	■	1	423428	■	1
70 KA	DPX <sup>3</sup> 250HP	40	423440	■	1	423445	■	1
		100	423441	■	1	423446	■	1
		160	423442	■	1	423447	■	1
		250	423443	■	1	423448	■	1
100 KA	DPX <sup>3</sup> 250HP	40	423450	■	1	423455	■	1
		100	423451	■	1	423456	■	1
		160	423452	■	1	423457	■	1
		250	423453	■	1	423458	■	1

#### Electronic S10 (LSIg) Protection Unit with Measure

36 KA	DPX <sup>3</sup> 250HP	40	423460	■	1	423465	■	1
		100	423461	■	1	423466	■	1
		160	423462	■	1	423467	■	1
		250	423463	■	1	423468	■	1
50 KA	DPX <sup>3</sup> 250HP	40	423480	■	1	423485	■	1
		100	423481	■	1	423486	■	1
		160	423482	■	1	423487	■	1
		250	423483	■	1	423488	■	1
70 KA	DPX <sup>3</sup> 250HP	40	423500	■	1	423505	■	1
		100	423501	■	1	423506	■	1
		160	423502	■	1	423507	■	1
		250	423503	■	1	423508	■	1
100 KA	DPX <sup>3</sup> 250HP	40	423510	■	1	423515	■	1
		100	423511	■	1	423516	■	1
		160	423512	■	1	423517	■	1
		250	423513	■	1	423518	■	1

■ Price available on request.

\* MRP - Maximum Retail Price Inclusive of all taxes including GST.

Bold Cat.Nos are products normally available with Legrand (India) Stockists. Cat.Nos that are not bold - delivery within 4 - 8 weeks from the date of order. Bold packing quantity is our mandatory packing. Orders to be placed by Legrand (India) Stockist in multiples of the same.

## DPX<sup>3</sup> MCCB

### DPX<sup>3</sup> 250 HP MCCB with New Electronics S10 Protection Unit

Category	Type	Rated Current (A)	3P			4P		
			Cat.Nos	MRP*/₹/Unit	Pack	Cat.Nos	MRP*/₹/Unit	Pack

#### Electronic S10 (LSIg) Protection Unit with Electronic earth leakage module - Fixed version

36 KA	DPX <sup>3</sup> 250HP	40	■	■	■	423475	■	1
		100	■	■	■	423476	■	1
		160	■	■	■	423477	■	1
		250	■	■	■	423478	■	1
50 KA	DPX <sup>3</sup> 250HP	40	■	■	■	423495	■	1
		100	■	■	■	423496	■	1
		160	■	■	■	423497	■	1
		250	■	■	■	423498	■	1

Cat.Nos	Description	MRP* ₹ / Unit	Pack
---------	-------------	------------------	------

#### Accessories of DPX<sup>3</sup> 250 HP

423814	DPX <sup>3</sup> 250HP RH DIRECT STD	1810	1
423815	DPX <sup>3</sup> 250HP RH DIRECT EMERG	1970	1
423816	DPX <sup>3</sup> 250HP RH VARI DEPTH STD	2980	1
423817	DPX <sup>3</sup> 250HP RH VARI DEPTH EMERG	3230	1
423804	Locking supports for direct handle	■	1
423805	Locking supports for vari-depth handle	■	1
423806	1 N/C + 1 N/O auxiliary contact for rotary handles	■	1
423840	Front installation motor operators-24 V AC	■	1
423841	Front installation motor operators- 48 V AC	■	1
423842	Front installation motor operators- 110 V AC	■	1
423843	Front installation motor operators- 230 V AC	■	1
423845	Locking support for motor operators Cat.Nos 4 238 40/41/42/43. To be equipped with universal keylocks Cat.No 4 238 80/81/82/83	■	1
423846	Padlock for motor operators Cat.Nos 4 238 40/41/42/43	■	1

Cat.Nos	Description	MRP* ₹ / Unit	Pack
---------	-------------	------------------	------

#### Accessories of DPX<sup>3</sup> 250 HP

423834	Set of 2 insulated shields for DPX <sup>3</sup> HP 125/250 3P	■	
423835	Set of 3 insulated shields for DPX <sup>3</sup> HP 125/250 4P	■	
421049	Padlock for locking in "open" position for DPX <sup>3</sup> 160/250 and DPX <sup>3</sup> 125/250 HP	■	
423830	DPX <sup>3</sup> 250 HP CAGE TERMINAL FOR	4460	1
423831	DPX <sup>3</sup> 250 HP CAGE TERMINAL FOR	5800	1
423821	DPX <sup>3</sup> 250HP REAR TERMINALS 3P	6080	1
423822	DPX <sup>3</sup> 250HP REAR TERMINALS 4P	8190	1
625014	TP SPRDR LINK SET FOR DPX250ER	1020	1
625018	FP SPDR LINK SET FOR DPX250ER	1380	1
421011	DPX <sup>3</sup> aux cont & fault signals	1620	1
421012	DPX <sup>3</sup> SHUNT RELEASE-12VAC/DC	3600	1
421013	DPX <sup>3</sup> shu.rel-coil vol.24VAC/DC	3600	1
421014	DPX <sup>3</sup> SHUNT RELEASE-48VAC/DC	3600	1
421015	DPX <sup>3</sup> shunt release 110V-130V AC	3600	1
421016	DPX <sup>3</sup> shunt release 220V-277V AC	3600	1
421017	DPX <sup>3</sup> shunt release 380V-415V AC	3600	1
421018	DPX <sup>3</sup> UNDER VOLT.REL-12VAC/DC	4510	1

■ Price available on request.

\* MRP - Maximum Retail Price Inclusive of all taxes including GST.

Bold Cat.Nos are products normally available with Legrand (India) Stockists. Cat.Nos that are not bold - delivery within 4 - 8 weeks from the date of order. Bold packing quantity is our mandatory packing. Orders to be placed by Legrand (India) Stockist in multiples of the same.

## DPX<sup>3</sup> MCCB

### DPX<sup>3</sup> 250 HP MCCB with New Electronics S10 Protection Unit

Cat.Nos	Description	MRP* ₹ / Unit	Pack
<b>Accessories of DPX<sup>3</sup> 250 HP</b>			
421019	DPX <sup>3</sup> UNDER VOLT.REL-24VAC/DC	4510	1
421020	DPX <sup>3</sup> UNDER VOLT.REL-48VAC/DC	4510	1
421021	DPX <sup>3</sup> UNDER VOLT.REL-110VAC/DC	4460	1
421022	DPX <sup>3</sup> Undervoltage release 200V- 240VAC	4460	1
421023	DPX <sup>3</sup> UNDER VOLT.REL-277AVC/DC	4460	1
421024	DPX <sup>3</sup> Undervoltage release 380V- 415V AC	4460	1
421025	DPX <sup>3</sup> UND.VOL.REL-440-480VAC/DC	4460	1
026190	Time-lag modules - 3 Module	■	1
026191	Time-lag modules-3 Module	■	1
421049	Padlocking for locking in "Open" position for DPX <sup>3</sup> 125/250HP	28420	1
423814	DPX <sup>3</sup> 250HP RH DIRECT STD	1810	1
423815	DPX <sup>3</sup> 250HP RH DIRECT EMERG	1970	1
423816	DPX <sup>3</sup> 250HP RH VARI DEPTH STD	2980	1
423817	DPX <sup>3</sup> 250HP RH VARI DEPTH EMERG	3230	1
423806	AUXILIARY CNT BLOCK 1N/C+1 N/O	2010	1
423850	Plug-in bases for DPX <sup>3</sup> 250 HP - 3P	■	1
423851	Plug-in bases for DPX <sup>3</sup> 250 HP - 4P	■	1
423852	Plug-in Plug-in mobile part kit for DPX <sup>3</sup> 250 HP - 3P	■	1
423853	Plug-in Plug-in mobile part kit for DPX <sup>3</sup> 250 HP - 4P	■	1
423863	Locking support for plug-in version. To be equipped with universal keylocks Cat.No 4 238 80/81/82/83	■	1
423860	Debro-lift mechanism for DPX <sup>3</sup> 250 HP ; Supplied with handle - 3P	■	1
423861	Debro-lift mechanism for DPX <sup>3</sup> 250 HP ; Supplied with handle - 4P	■	1

■ Price available on request.

\* MRP - Maximum Retail Price Inclusive of all taxes including GST.

Cat.Nos	Description	MRP* ₹ / Unit	Pack
<b>Accessories of DPX<sup>3</sup> 250 HP</b>			
423855	Draw-out front cover masks for DPX <sup>3</sup> 250 HP alone	■	1
423856	Draw-out front cover masks for DPX <sup>3</sup> 250 HP with motor-driven handle	■	1
423862	Enable locking of DPX <sup>3</sup> 250 HP in draw-out position. To be equipped with universal keylocks Cat.No 4 238 80/81/82/83	■	1
423864	Enable padlocking of DPX <sup>3</sup> HP in draw-out position	■	1
422230	Automatic auxiliary contact for DPX <sup>3</sup> HP draw-out version (up to 2 contacts by DPX <sup>3</sup> -HP)	■	1
009819	Signalling contact plugged-in / drawn-out	■	1
421048	Signalling Contact For DPX <sup>3</sup> 250 HP plug-in versions	■	1

**Bold Cat.Nos** are products normally available with Legrand (India) Stockists. Cat.Nos that are not bold - delivery within 4 - 8 weeks from the date of order. Bold packing quantity is our mandatory packing. Orders to be placed by Legrand (India) Stockist in multiples of the same.

## DPX<sup>3</sup> MCCB

### DPX<sup>3</sup> MCCB with New Electronics S1 Protection Unit

DPX<sup>3</sup> MCCB with electronic S1 (LSI) protection unit

- Configurable Protections with Enable and Disable possibility
- Range: 320A – 1600A, Ics=100%Icu, Two Optimum Frames
- Protection against Overloads:
  - Ir adjustable from OFF-0.4 to 1 x In
  - tr adjustable- 5s
- Protection against Short Circuits:
  - I<sub>sd</sub> adjustable 1.5 to 10I<sub>r</sub>
  - tsd - 100ms
- Breaking Capacity – 36kA, 50kA, 70kA & 100kA

Category	Type	Rated Current (A)	3P			4P		
			Cat.Nos	MRP*/₹/Unit	Pack	Cat.Nos	MRP*/₹/Unit	Pack

#### Electronic S1 (LSI) Protection Unit

36 KA	DPX <sup>3</sup> 630	320	422499	57520	1	422504	70300	1
		400	422500	57520	1	422505	70300	1
		500	422501	64370	1	422506	86340	1
		630	422502	65720	1	422507	88170	1
	DPX <sup>3</sup> 1600	800	422540	110020	1	422546	131260	1
		1000	422541	164380	1	422547	242590	1
		1250	422542	198080	1	422548	295050	1
		1600	422543	245140	1	422549	329270	1
50 KA	DPX <sup>3</sup> 630	320	422509	65310	1	422514	83310	1
		400	422510	65310	1	422515	83310	1
		500	422511	76320	1	422516	95410	1
		630	422512	76320	1	422517	95410	1
	DPX <sup>3</sup> 1600	800	422552	126500	1	422558	155370	1
		1000	422553	175950	1	422559	245210	1
		1250	422554	213510	1	422560	311220	1
		1600	422555	299020	1	422561	352010	1

■ Price available on request.

\* MRP - Maximum Retail Price Inclusive of all taxes including GST.

Bold Cat.Nos are products normally available with Legrand (India) Stockists. Cat.Nos that are not bold - delivery within 4 - 8 weeks from the date of order. Bold packing quantity is our mandatory packing. Orders to be placed by Legrand (India) Stockist in multiples of the same.

## DPX<sup>3</sup> MCCB

### DPX<sup>3</sup> MCCB with New Electronics S1 Protection Unit

Category	Type	Rated Current (A)	3P			4P		
			Cat.Nos	MRP*/₹/Unit	Pack	Cat.Nos	MRP*/₹/Unit	Pack
<b>Electronic S1 (LSI) Protection Unit with Electronic Earth Leakage Module - Fixed version</b>								
70 KA	DPX <sup>3</sup> 630	320	422519	82810	1	422524	106900	1
		400	422520	82810	1	422525	106900	1
		500	422521	89510	1	422526	120180	1
		630	422522	89510	1	422527	120180	1
	DPX <sup>3</sup> 1600	800	422564	165030	1	422570	208860	1
		1000	422565	231270	1	422571	330060	1
		1250	422566	276950	1	422572	385070	1
		1600	422567	372320	1	422573	458410	1
100 KA	DPX <sup>3</sup> 630	320	422529	■	1	422534	■	1
		400	422530	■	1	422535	■	1
		500	422531	■	1	422536	■	1
		630	422532	■	1	422537	■	1
	DPX <sup>3</sup> 1600	800	422576	■	1	422582	■	1
		1000	422577	■	1	422583	■	1
		1250	422578	■	1	422584	■	1

■ Price available on request.

\* MRP - Maximum Retail Price Inclusive of all taxes including GST.

Bold Cat.Nos are products normally available with Legrand (India) Stockists. Cat.Nos that are not bold - delivery within 4 - 8 weeks from the date of order. Bold packing quantity is our mandatory packing. Orders to be placed by Legrand (India) Stockist in multiples of the same.

## DPX<sup>3</sup> MCCB

### DPX<sup>3</sup> MCCB with New Electronics S10 Protection Unit

DPX<sup>3</sup> MCCB with electronic S10 (LSIg) & energy metering protection unit

- Configurable Protections with Enable and Disable possibility
- Range: 250A – 1600A, Ics=100%Icu, Two Optimum Frames
- Protection against Overloads:
  - Ir adjustable from OFF-0.2 to 1 x In
  - tr adjustable from 3 to 30s
- Protection against Short Circuits:
  - Isd adjustable from OFF-1.5 to 10 x Ir
  - tsd adjustable from 0 to 0.5s
- Inbuilt Instantaneous Protection:
  - li – Fixed and 2 to 15x In through PCS
- Protection against Ground Fault:
  - Ig adjustable from 0.2 to 1 In & OFF
  - tg adjustable from 0.80ms to 1s
- Protection against Neutral Fault:
  - OFF-50% -100% -150% -200%
- Breaking Capacity – 36kA, 50kA, 70kA & 100kA
- Integrated energy metering with accuracy class 1
- Measure for currents, voltage, frequency, power, energy, THD and Individual harmonics
- Internal Battery with battery measure function
- Communication ready
- Logical Selectivity Ready (Zone Selective Interlocking)
- In Built USB Port for Software Diagnosis
- Switchable Thermal Memory
- Suitable for Isolation

Category	Type	Rated Current (A)	3P			4P		
			Cat.Nos	MRP*/₹/Unit	Pack	Cat.Nos	MRP*/₹/Unit	Pack

#### Electronic S10 (LSIg) Protection Unit

36 KA	DPX <sup>3</sup> 630	320	422821	76110	1	422826	82520	1
		400	422822	76110	1	422827	82520	1
		500	422823	79020	1	422828	95080	1
		630	422824	79020	1	422829	95080	1
	DPX <sup>3</sup> 1600	800	422921	160140	1	422926	193040	1
		1000	422922	212790	1	422927	280000	1
		1250	422923	239110	1	422928	320250	1
		1600	422924	248620	1	422929	376070	1
50 KA	DPX <sup>3</sup> 630	320	422831	77040	1	422836	89620	1
		400	422832	77040	1	422837	89620	1
		500	422833	84560	1	422838	106640	1
		630	422834	84560	1	422839	106640	1
	DPX <sup>3</sup> 1600	800	422931	185370	1	422936	210990	1
		1000	422932	230260	1	422937	291870	1
		1250	422933	254420	1	422938	325590	1
		1600	422934	271440	1	422939	386410	1
70 KA	DPX <sup>3</sup> 630	320	422841	90350	1	422846	111480	1
		400	422842	90350	1	422847	111480	1
		500	422843	104040	1	422848	141570	1
		630	422844	104040	1	422849	141570	1
	DPX <sup>3</sup> 1600	800	422941	174500	1	422946	210450	1
		1000	422942	243910	1	422947	377350	1
		1250	422943	339800	1	422948	436840	1
		1600	422944	458830	1	422949	514960	1

■ Price available on request.

\* MRP - Maximum Retail Price Inclusive of all taxes including GST.

Bold Cat.Nos are products normally available with Legrand (India) Stockists. Cat.Nos that are not bold - delivery within 4 - 8 weeks from the date of order. Bold packing quantity is our mandatory packing. Orders to be placed by Legrand (India) Stockist in multiples of the same.

## DPX<sup>3</sup> MCCB

### DPX<sup>3</sup> MCCB with New Electronics S10 Protection Unit

Category	Type	Rated Current (A)	3P			4P		
			Cat.Nos	MRP*/₹/Unit	Pack	Cat.Nos	MRP*/₹/Unit	Pack

#### Electronic S10 (LSIg) Protection Unit

100 KA	DPX <sup>3</sup> 630	320	422851	■	1	422856	■	1
		400	422852	■	1	422857	■	1
		500	422853	■	1	422858	■	1
		630	422854	■	1	422859	■	1
	DPX <sup>3</sup> 1600	800	422951	■	1	422956	■	1
		1000	422952	■	1	422957	■	1
1250		422953	■	1	422958	■	1	

#### Electronic S10 (LSIg) Protection Unit with Measure

36 KA	DPX <sup>3</sup> 630	320	422861	95430	1	422866	108530	1
		400	422862	95430	1	422867	108530	1
		500	422863	101280	1	422868	122920	1
		630	422864	101280	1	422869	122920	1
	DPX <sup>3</sup> 1600	800	422961	184500	1	422966	214950	1
		1000	422962	235660	1	422967	309620	1
		1250	422963	255580	1	422968	345110	1
1600		422964	270760	1	422969	400330	1	
50 KA	DPX <sup>3</sup> 630	320	422871	100240	1	422876	115720	1
		400	422872	100240	1	422877	115720	1
		500	422873	110320	1	422878	134660	1
		630	422874	110320	1	422879	134660	1
	DPX <sup>3</sup> 1600	800	422971	166710	1	422976	201150	1
		1000	422972	199110	1	422977	299760	1
		1250	422973	283980	1	422978	366810	1
		1600	422974	335260	1	422979	426950	1
70 KA	DPX <sup>3</sup> 630	320	422881	113550	1	422886	133940	1
		400	422882	113550	1	422887	133940	1
		500	422883	126830	1	422888	163140	1
		630	422884	126830	1	422889	163140	1
	DPX <sup>3</sup> 1600	800	422981	177080	1	422986	229750	1
		1000	422982	280030	1	422987	371580	1
		1250	422983	322040	1	422988	426420	1
		1600	422984	426560	1	422989	498450	1
100 KA	DPX <sup>3</sup> 630	320	422891	■	1	422896	■	1
		400	422892	■	1	422897	■	1
		500	422893	■	1	422898	■	1
		630	422894	■	1	422899	■	1
	DPX <sup>3</sup> 1600	800	422991	■	1	422996	■	1
		1000	422992	■	1	422997	■	1
		1250	422993	■	1	422998	■	1

■ Price available on request.

\* MRP - Maximum Retail Price Inclusive of all taxes including GST.

Bold Cat.Nos are products normally available with Legrand (India) Stockists. Cat.Nos that are not bold - delivery within 4 - 8 weeks from the date of order. Bold packing quantity is our mandatory packing. Orders to be placed by Legrand (India) Stockist in multiples of the same.

## DPX<sup>3</sup> MCCB

### DPX<sup>3</sup> MCCB with Thermal Magnetic Protection Unit

- Range: 16A – 1250A, Ics=100%Icu, Four Optimum Frames
- Thermal Adjustable – 0.8 to 1In, Magnetic Adjustable\*\* – 5 to 10In
- Breaking Capacity# – 16kA, 25kA, 36kA, 50kA, 70kA & 100kA
- Option for In built or add on module for Earth Leakage Protection##
  - Adjustable sensitivity: 0.03 - 0.3 - 1 - 3 A
  - Adjustable tripping: 0 - 0.3 - 1 - 3s
- Suitable for Isolation

\*\* Fixed at 10In for DPX<sup>3</sup> 160

# Refer Catalogue for frame wise data

## For DPX<sup>3</sup> 160, DPX<sup>3</sup> 250 and DPX<sup>3</sup> 630 Only

Category	Type	Rated Current (A)	3P			4P		
			Cat.Nos	MRP*/₹/Unit	Pack	Cat.Nos	MRP*/₹/Unit	Pack

#### Thermal Magnetic : O/L & S/C Protection

16 KA	DPX <sup>3</sup> 160	16	4200 00	9700	1	4200 10	12920	1
		25	4200 01	9700	1	4200 11	12920	1
		40	4200 02	9700	1	4200 12	12920	1
		63	4200 03	9700	1	4200 13	12920	1
		80	4200 04	9700	1	4200 14	12920	1
		100	4200 05	9700	1	4200 15	12920	1
		125	4200 06	10490	1	4200 16	13010	1
		160	4200 07	13540	1	4200 17	17040	1
25 KA	DPX <sup>3</sup> 160	16	4200 40	11340	1	4200 50	15760	1
		25	4200 41	11340	1	4200 51	15760	1
		40	4200 42	11340	1	4200 52	15760	1
		63	4200 43	11340	1	4200 53	15760	1
		80	4200 44	11340	1	4200 54	15760	1
		100	4200 45	11340	1	4200 55	15760	1
		125	4200 46	16390	1	4200 56	19900	1
		160	4200 47	21310	1	4200 57	25340	1
	DPX <sup>3</sup> 250	200	4202 08	29450	1	4202 18	35580	1
		250	4202 09	34140	1	4202 19	46010	1

■ Price available on request.

\* MRP - Maximum Retail Price Inclusive of all taxes including GST.

Bold Cat.Nos are products normally available with Legrand (India) Stockists. Cat.Nos that are not bold - delivery within 4 - 8 weeks from the date of order. Bold packing quantity is our mandatory packing. Orders to be placed by Legrand (India) Stockist in multiples of the same.

## DPX<sup>3</sup> MCCB

### DPX<sup>3</sup> MCCB with Thermal Magnetic Protection Unit

Category	Type	Rated Current (A)	3P			4P		
			Cat.Nos	MRP*/₹/Unit	Pack	Cat.Nos	MRP*/₹/Unit	Pack

#### Thermal Magnetic : O/L & S/C Protection

36 KA	DPX <sup>3</sup> 160	16	4200 80	14360	1	4200 90	17930	1
		25	4200 81	14360	1	4200 91	17930	1
		40	4200 82	14360	1	4200 92	17930	1
		63	4200 83	14360	1	4200 93	17930	1
		80	4200 84	14360	1	4200 94	17930	1
		100	4200 85	14360	1	4200 95	17930	1
		125	4200 86	16850	1	4200 96	21980	1
		160	4200 87	21700	1	4200 97	25550	1
	DPX <sup>3</sup> 250	200	4202 38	37120	1	4202 48	46930	1
		250	4202 39	41180	1	4202 49	50260	1
	DPX <sup>3</sup> 630	320	4220 01	49730	1	4220 06	56480	1
		400	4220 02	49730	1	4220 07	57720	1
		500	4220 03	59830	1	4220 08	71170	1
		630	4220 04	59830	1	4220 09	73000	1
DPX <sup>3</sup> 1600	800	4222 52	91310	1	4222 57	106190	1	
	1000	4222 53	107570	1	4222 58	150650	1	
	1250	4222 54	166160	1	4222 59	181240	1	

■ Price available on request.

\* MRP - Maximum Retail Price inclusive of all taxes including GST.

Bold Cat.Nos are products normally available with Legrand (India) Stockists. Cat.Nos that are not bold - delivery within 4 - 8 weeks from the date of order. Bold packing quantity is our mandatory packing. Orders to be placed by Legrand (India) Stockist in multiples of the same.

## DPX<sup>3</sup> MCCB

### DPX<sup>3</sup> MCCB with Thermal Magnetic Protection Unit

Category	Type	Rated Current (A)	3P			4P		
			Cat.Nos	MRP*/₹/Unit	Pack	Cat.Nos	MRP*/₹/Unit	Pack
<b>Thermal Magnetic : O/L &amp; S/C Protection</b>								
50 KA	DPX <sup>3</sup> 160	16	4201 20	19130	1	4201 30	24110	1
		25	4201 21	19130	1	4201 31	24110	1
		40	4201 22	19130	1	4201 32	24110	1
		63	4201 23	19130	1	4201 33	24110	1
		80	4201 24	19130	1	4201 34	24110	1
		100	4201 25	19130	1	4201 35	24110	1
		125	4201 26	25080	1	4201 36	28900	1
		160	4201 27	28220	1	4201 37	32830	1
	DPX <sup>3</sup> 250	200	4202 68	44980	1	4202 78	56820	1
		250	4202 69	47470	1	4202 79	59100	1
	DPX <sup>3</sup> 630	320	4220 15	49940	1	4220 20	65810	1
		400	4220 16	55150	1	4220 21	65810	1
		500	4220 17	63150	1	4220 22	86220	1
		630	4220 18	68270	1	4220 23	88400	1
	DPX <sup>3</sup> 1600	800	4222 64	100520	1	4222 69	125410	1
		1000	4222 65	153010	1	4222 70	177010	1
		1250	4222 66	224780	1	4222 71	236020	1
	70 KA	DPX <sup>3</sup> 250	100	4206 05	39400	1	4206 15	43490
160			4206 07	49220	1	4206 17	61200	1
200			4206 08	60610	1	4206 18	74580	1
250			4206 09	64420	1	4206 19	77640	1
DPX <sup>3</sup> 630		320	4220 29	65260	1	4220 34	80820	1
		400	4220 30	65270	1	4220 35	80820	1
		500	4220 31	76200	1	4220 36	98180	1
		630	4220 32	80090	1	4220 37	106140	1
DPX <sup>3</sup> 1600		800	4222 76	148620	1	4222 81	186260	1
		1000	4222 77	222840	1	4222 82	315530	1
		1250	4222 78	228300	1	4222 83	393340	1

\* MRP - Maximum Retail Price Inclusive of all taxes including GST.  
 ■ Price available on request.

Bold Cat.Nos are products normally available with Legrand (India) Stockists. Cat.Nos that are not bold - delivery within 4 - 8 weeks from the date of order. Bold packing quantity is our mandatory packing. Orders to be placed by Legrand (India) Stockist in multiples of the same.

## DPX<sup>3</sup> MCCB

### DPX<sup>3</sup> MCCB with Thermal Magnetic Protection Unit

Category	Type	Rated Current (A)	3P			4P				
			Cat.Nos	MRP*/₹/Unit	Pack	Cat.Nos	MRP*/₹/Unit	Pack		
<b>Thermal Magnetic + Electronic Earth Leakage Module</b>										
16 KA	DPX <sup>3</sup> 160	16	-	-	-	4200 30	41830	1		
		25	-	-	-	4200 31	41830	1		
		40	-	-	-	4200 32	41830	1		
		63	-	-	-	4200 33	41830	1		
		80	-	-	-	4200 34	41830	1		
		100	-	-	-	4200 35	41830	1		
		125	-	-	-	4200 36	44110	1		
		160	-	-	-	4200 37	55970	1		
25 KA	DPX <sup>3</sup> 160	16	-	-	-	4200 70	52950	1		
		25	-	-	-	4200 71	52950	1		
		40	-	-	-	4200 72	52950	1		
		63	-	-	-	4200 73	52950	1		
		80	-	-	-	4200 74	52950	1		
		100	-	-	-	4200 75	52950	1		
		125	-	-	-	4200 76	52970	1		
		160	-	-	-	4200 77	62540	1		
	DPX <sup>3</sup> 250	100	-	-	-	4202 25	63840	1		
		160	-	-	-	4202 27	67100	1		
		200	-	-	-	4202 28	69700	1		
		250	-	-	-	4202 29	74540	1		
		36 KA	DPX <sup>3</sup> 160	16	-	-	-	4201 10	64410	1
				25	-	-	-	4201 11	64410	1
40	-			-	-	4201 12	64410	1		
63	-			-	-	4201 13	64410	1		
80	-			-	-	4201 14	64410	1		
100	-			-	-	4201 15	64410	1		
125	-			-	-	4201 16	64760	1		
160	-			-	-	4201 17	77030	1		
DPX <sup>3</sup> 250	100	-	-	-	4202 55	66640	1			
	160	-	-	-	4202 57	77630	1			
	200	-	-	-	4202 58	81410	1			
	250	-	-	-	4202 59	87060	1			
50 KA	DPX <sup>3</sup> 160	16	-	-	-	4201 50	74590	1		
		25	-	-	-	4201 51	74590	1		
		40	-	-	-	4201 52	74590	1		
		63	-	-	-	4201 53	74590	1		
		80	-	-	-	4201 54	74590	1		
		100	-	-	-	4201 55	74590	1		
		125	-	-	-	4201 56	79470	1		
		160	-	-	-	4201 57	85040	1		
	DPX <sup>3</sup> 250	100	-	-	-	4202 85	79960	1		
		160	-	-	-	4202 87	92560	1		
		200	-	-	-	4202 88	97530	1		
		250	-	-	-	4202 89	103630	1		

■ Price available on request.

\* MRP - Maximum Retail Price Inclusive of all taxes including GST.

Bold Cat.Nos are products normally available with Legrand (India) Stockists. Cat.Nos that are not bold - delivery within 4 - 8 weeks from the date of order. Bold packing quantity is our mandatory packing. Orders to be placed by Legrand (India) Stockist in multiples of the same.

## DPX<sup>3</sup> MCCB

### DPX<sup>3</sup> MCCB with Electronic S2\* (LSI)\* Protection Pnit

- Range: 40A – 1600A, Ics=100%Icu, Three Optimum Frames
- Protection against overloads:
  - Ir adjustable from 0.4 to 1 x In
  - tr adjustable from 3 to 30s#
- Protection against short circuits:
  - Isd adjustable from 1.5 to 10 x Ir
  - tsd adjustable from 0 to 0.5s
- Inbuilt Instantaneous Protection:
  - li# – Fixed
- Option for In built or add on module for Earth Leakage Protection##
  - Adjustable sensitivity: 0.03 - 0.3 - 1 - 3 A
  - Adjustable tripping: 0 - 0.3 - 1 - 3s
- Breaking Capacity# – 25kA, 36kA, 50kA, 70kA & 100kA
- In built Display for Current Metering with accuracy of class 1
- Internal Battery with battery measure function
- Communication Ready via COMM Port
- Logical Selectivity Ready (Zone Selective Interlocking)
- Dynamic Selectivity as per Selectivity Charts
- In Built USB Port for Software Diagnosis
- Suitable for Isolation

Category	Type	Rated Current (A)	3P			4P		
			Cat.Nos	MRP*/₹/Unit	Pack	Cat.Nos	MRP*/₹/Unit	Pack

### Electronic S2

25 KA	DPX <sup>3</sup> 250	40	4203 02	31420	1	4203 12	41260	1
		100	4203 05	31420	1	4203 15	41260	1
		160	4203 07	40700	1	4203 17	48680	1
		250	4203 09	53080	1	4203 19	65810	1
36 KA	DPX <sup>3</sup> 250	40	4203 32	35290	1	4203 42	43500	1
		100	4203 35	35290	1	4203 45	43500	1
		160	4203 37	44230	1	4203 47	59010	1
		250	4203 39	59260	1	4203 49	68190	1
	DPX <sup>3</sup> 630	320	4220 57	■	1	4220 62	■	1
		400	4220 58	■	1	4220 63	■	1
		500	4220 59	■	1	4220 64	■	1
		630	4220 60	■	1	4220 65	■	1
DPX <sup>3</sup> 1600	800	4223 00	■	1	4223 06	■	1	
	1000	4223 01	■	1	4223 07	■	1	
	1250	4223 02	■	1	4223 08	■	1	
	1600	4223 03	■	1	4223 09	■	1	
50 KA	DPX <sup>3</sup> 250	40	4203 62	41960	1	4203 72	55910	1
		100	4203 65	41960	1	4203 75	55910	1
		160	4203 67	50650	1	4203 77	60490	1
		250	4203 69	67590	1	4203 79	81820	1
	DPX <sup>3</sup> 630	320	4220 67	■	1	4220 72	■	1
		400	4220 68	■	1	4220 73	■	1
		500	4220 69	■	1	4220 74	■	1
		630	4220 70	■	1	4220 75	■	1
	DPX <sup>3</sup> 1600	800	4223 12	■	1	4223 18	■	1
		1000	4223 13	■	1	4223 19	■	1
		1250	4223 14	■	1	4223 20	■	1
		1600	4223 15	■	1	4223 21	■	1

\* MRP - Maximum Retail Price Inclusive of all taxes including GST.  
 ■ Price available on request.

Bold Cat.Nos are products normally available with Legrand (India) Stockists. Cat.Nos that are not bold - delivery within 4 - 8 weeks from the date of order. Bold packing quantity is our mandatory packing. Orders to be placed by Legrand (India) Stockist in multiples of the same.

## DPX<sup>3</sup> MCCB

### DPX<sup>3</sup> MCCB with Electronic S2<sup>#</sup> (LSI)<sup>#</sup> Protection Unit

Category	Type	Rated Current (A)	3P			4P		
			Cat.Nos	MRP*/₹/Unit	Pack	Cat.Nos	MRP*/₹/Unit	Pack

#### Electronic S2

70 KA	DPX <sup>3</sup> 250	40	4206 35	51350	1	4206 45	67920	1
		100	4206 37	51860	1	4206 47	67920	1
		160	4206 38	67920	1	4206 48	78020	1
		250	4206 39	77540	1	4206 49	100080	1
	DPX <sup>3</sup> 630	320	4220 77	■	1	4220 82	■	1
		400	4220 78	■	1	4220 83	■	1
		500	4220 79	■	1	4220 84	■	1
		630	4220 80	■	1	4220 85	■	1
	DPX <sup>3</sup> 1600	800	4223 24	■	1	4223 30	■	1
		1000	4223 25	■	1	4223 31	■	1
		1250	4223 26	■	1	4223 32	■	1
		1600	4223 27	■	1	4223 33	■	1

#### Electronic S2 + Electronic Earth Leakage Module

25 kA	DPX <sup>3</sup> 250	40	-	-	■	4203 22	■	1
		100	-	-	■	4203 25	■	1
		160	-	-	■	4203 27	■	1
		250	-	-	■	4203 29	■	1
36 kA	DPX <sup>3</sup> 250	40	-	-	■	4203 52	■	1
		100	-	-	■	4203 55	■	1
		160	-	-	■	4203 57	■	1
		250	-	-	■	4203 59	■	1
50 kA	DPX <sup>3</sup> 250	40	-	-	■	4203 82	■	1
		100	-	-	■	4203 85	■	1
		160	-	-	■	4203 87	■	1
		250	-	-	■	4203 89	■	1
70 kA	DPX <sup>3</sup> 250	40	-	-	■	4206 55	■	1
		100	-	-	■	4206 57	■	1
		160	-	-	■	4206 58	■	1
		250	-	-	■	4206 59	■	1

■ Price available on request.

\* MRP - Maximum Retail Price Inclusive of all taxes including GST.

Bold Cat.Nos are products normally available with Legrand (India) Stockists. Cat.Nos that are not bold - delivery within 4 - 8 weeks from the date of order. Bold packing quantity is our mandatory packing. Orders to be placed by Legrand (India) Stockist in multiples of the same.

## DPX<sup>3</sup> MCCB

### DPX<sup>3</sup> MCCB with Electronic Sg (LSIg) Protection Unit

- Range: 40A – 1600A, Ics=100%Icu, Three Optimum Frames
- Protection against Overloads:
  - Ir adjustable from 0.4 to 1 x In
  - tr adjustable from 3 to 30s#
- Protection against Short Circuits:
  - Isd adjustable from 1.5 to 10 x Ir
  - tsd adjustable from 0 to 0.5s
- Inbuilt Instantaneous Protection:
  - li# – Fixed
- Protection against Ground Fault:
  - Ig adjustable from 0.2 to 1 In & OFF
  - tg adjustable from 0.1 to 1s
- Breaking Capacity#– 25kA, 36kA, 50kA, 70kA & 100kA
- In built Display for Current Metering with high accuracy of class 1
- Internal Battery with battery measure function
- Communication Ready via COMM Port
- Logical Selectivity Ready (Zone Selective Interlocking)
- Dynamic Selectivity as per Selectivity Charts
- In Built USB Port for Software Diagnosis
- Switchable Thermal Memory
- Suitable for Isolation

Category	Type	Rated Current (A)	3P			4P		
			Cat.Nos	MRP*/₹/Unit	Pack	Cat.Nos	MRP*/₹/Unit	Pack

### Electronic Sg

25 KA	DPX <sup>3</sup> 250	40	4205 02	58370	1	4205 12	65350	1
		100	4205 05	58370	1	4205 15	65350	1
		160	4205 07	64950	1	4205 17	72010	1
		250	4205 09	71800	1	4205 19	84020	1
36 KA	DPX <sup>3</sup> 250	40	4205 22	61810	1	4205 32	69650	1
		100	4205 25	61810	1	4205 35	69650	1
		160	4205 27	68260	1	4205 37	72390	1
		250	4205 29	70100	1	4205 39	74240	1
	DPX <sup>3</sup> 630	320	4221 37	■	1	4221 42	■	1
		400	4221 38	■	1	4221 43	■	1
		500	4221 39	■	1	4221 44	■	1
		630	4221 40	■	1	4221 45	■	1
DPX <sup>3</sup> 1600	800	4223 96	■	1	4224 02	■	1	
	1000	4223 97	■	1	4224 03	■	1	
	1250	4223 98	■	1	4224 04	■	1	
	1600	4223 99	■	1	4224 05	■	1	
50 KA	DPX <sup>3</sup> 250	40	4205 42	63660	1	4205 52	70370	1
		100	4205 45	63660	1	4205 55	70370	1
		160	4205 47	70070	1	4205 57	76640	1
		250	4205 49	71900	1	4205 59	89800	1
	DPX <sup>3</sup> 630	320	4221 47	■	1	4221 52	■	1
		400	4221 48	■	1	4221 53	■	1
		500	4221 49	■	1	4221 54	■	1
		630	4221 50	■	1	4221 55	■	1
	DPX <sup>3</sup> 1600	800	4224 08	■	1	4224 14	■	1
		1000	4224 09	■	1	4224 15	■	1
		1250	4224 10	■	1	4224 16	■	1
		1600	4224 11	■	1	4224 17	■	1

\* MRP - Maximum Retail Price Inclusive of all taxes including GST.  
 ■ Price available on request.

Bold Cat.Nos are products normally available with Legrand (India) Stockists.  
 Cat.Nos that are not bold - delivery within 4 - 8 weeks from the date of order.  
 Bold packing quantity is our mandatory packing. Orders to be placed by Legrand (India) Stockist in multiples of the same.

## DPX<sup>3</sup> MCCB

### DPX<sup>3</sup> MCCB with Electronic Sg (LSIg) Protection Unit

Category	Type	Rated Current (A)	3P			4P		
			Cat.Nos	MRP*/₹/Unit	Pack	Cat.Nos	MRP*/₹/Unit	Pack

#### Electronic Sg

70 kA	DPX <sup>3</sup> 250	40	4206 92	66910	1	4207 02	75840	1
		100	4206 95	66910	1	4207 05	75840	1
		160	4206 97	78230	1	4207 07	87460	1
		250	4206 99	80120	1	4207 09	92060	1
	DPX <sup>3</sup> 630	320	4221 57	■	1	4221 62	■	1
		400	4221 58	■	1	4221 63	■	1
		500	4221 59	■	1	4221 64	■	1
		630	4221 60	■	1	4221 65	■	1
	DPX <sup>3</sup> 1600	800	4224 20	■	1	4224 26	■	1
		1000	4224 21	■	1	4224 27	■	1
		1250	4224 22	■	1	4224 28	■	1
		1600	4224 23	■	1	4224 29	■	1

## DPX<sup>3</sup> MCCB

### DPX<sup>3</sup> MCCB with Electronic S2<sup>#</sup> (LSI)<sup>#</sup> & Energy Metering Protection Unit

- Range: 40A – 1600A, Ics=100%Icu, Three Optimum Frames
- Protection against overloads:
  - Ir adjustable from 0.4 to 1 x In
  - tr adjustable from 3 to 30s#
- Protection against short circuits:
  - Isd adjustable from 1.5 to 10 x Ir
  - tsd adjustable from 0 to 0.5s
- Inbuilt Instantaneous Protection:
  - li# – Fixed
- Option for In built or add on module for Earth Leakage Protection##
  - Adjustable sensitivity: 0.03 - 0.3 - 1 - 3 A
  - Adjustable tripping: 0 - 0.3 - 1 - 3s
- Breaking Capacity# – 25kA, 36kA, 50kA, 70kA & 100kA
- Integrated energy metering with accuracy class 2
- Measure for currents, voltage, frequency, power, energy and harmonics
- Internal Battery with battery measure function
- Communication Ready via COMM Port
- Logical Selectivity Ready (Zone Selective Interlocking)
- Dynamic Selectivity as per Selectivity Charts
- In Built USB Port for Software Diagnosis
- Suitable for Isolation

Category	Type	Rated Current (A)	3P			4P		
			Cat.Nos	MRP*/₹/Unit	Pack	Cat.Nos	MRP*/₹/Unit	Pack

#### Electronic S2 + Energy Metering

25 KA	DPX <sup>3</sup> 250	40	4204 02	62990	1	4204 12	72110	1
		100	4204 05	62990	1	4204 15	72130	1
		160	4204 07	68300	1	4204 17	78180	1
		250	4204 09	73950	1	4204 19	84320	1
36 kA	DPX <sup>3</sup> 250	40	4204 32	67370	1	4204 42	73170	1
		100	4204 35	67370	1	4204 45	73170	1
		160	4204 37	73460	1	4204 47	82110	1
		250	4204 39	79370	1	4204 49	92390	1
	DPX <sup>3</sup> 630	320	4220 97	■	1	4221 02	■	1
		400	4220 98	■	1	4221 03	■	1
		500	4220 99	■	1	4221 04	■	1
		630	4221 00	■	1	4221 05	■	1

■ Price available on request.

\* MRP - Maximum Retail Price Inclusive of all taxes including GST.

Bold Cat.Nos are products normally available with Legrand (India) Stockists. Cat.Nos that are not bold - delivery within 4 - 8 weeks from the date of order. Bold packing quantity is our mandatory packing. Orders to be placed by Legrand (India) Stockist in multiples of the same.

**DPX<sup>3</sup> MCCB**  
**DPX<sup>3</sup> MCCB with Electronic S2<sup>#</sup> (LSI)<sup>#</sup> & Energy Metering Protection Unit**

Category	Type	Rated Current (A)	3P			4P		
			Cat.Nos	MRP*/₹/Unit	Pack	Cat.Nos	MRP*/₹/Unit	Pack

**Electronic S2 + Energy Metering**

36 KA	DPX <sup>3</sup> 1600	800	4223 48	■	1	4223 54	■	1
		1000	4223 49	■	1	4223 55	■	1
		1250	4223 50	■	1	4223 56	■	1
		1600	4223 51	■	1	4223 57	■	1
50 KA	DPX <sup>3</sup> 250	40	4204 62	75880	1	4204 72	82150	1
		100	4204 65	75880	1	4204 75	82150	1
		160	4204 67	83350	1	4204 77	90320	1
		250	4204 69	88130	1	4204 79	101770	1
	DPX <sup>3</sup> 630	320	4221 07	■	1	4221 12	■	1
		400	4221 08	■	1	4221 13	■	1
		500	4221 09	■	1	4221 14	■	1
		630	4221 10	■	1	4221 15	■	1
DPX <sup>3</sup> 1600	800	4223 60	■	1	4223 66	■	1	
	1000	4223 61	■	1	4223 67	■	1	
	1250	4223 62	■	1	4223 68	■	1	
	1600	4223 63	■	1	4223 69	■	1	
70 KA	DPX <sup>3</sup> 250	40	4206 65	79690	1	4206 75	88200	1
		100	4206 67	79690	1	4206 77	88200	1
		160	4206 68	95260	1	4206 78	101180	1
		250	4206 69	95430	1	4206 79	138780	1
	DPX <sup>3</sup> 630	320	4221 17	■	1	4221 22	■	1
		400	4221 18	■	1	4221 23	■	1
		500	4221 19	■	1	4221 24	■	1
		630	4221 20	■	1	4221 25	■	1
DPX <sup>3</sup> 1600	800	4223 72	■	1	4223 78	■	1	
	1000	4223 73	■	1	4223 79	■	1	
	1250	4223 74	■	1	4223 80	■	1	
	1600	4223 75	■	1	4223 81	■	1	

**Electronic S2 + Energy Metering + Electronic Earth Leakage Module**

25 KA	DPX <sup>3</sup> 250	40	■	■	■	4204 22	135710	1
		100	■	■	■	4204 25	136360	1
		160	■	■	■	4204 27	144990	1
		250	■	■	■	4204 29	163310	1
36 KA	DPX <sup>3</sup> 250	40	■	■	■	4204 52	137450	1
		100	■	■	■	4204 55	137630	1
		160	■	■	■	4204 57	146160	1
		250	■	■	■	4204 59	163880	1
50 KA	DPX <sup>3</sup> 250	40	■	■	■	4204 82	142840	1
		100	■	■	■	4204 85	144040	1
		160	■	■	■	4204 87	153300	1
		250	■	■	■	4204 89	172410	1
70 KA	DPX <sup>3</sup> 250	40	■	■	■	4206 85	143880	1
		100	■	■	■	4206 87	145190	1
		160	■	■	■	4206 88	153770	1
		250	■	■	■	4206 89	183050	1

\* MRP - Maximum Retail Price Inclusive of all taxes including GST.  
 ■ Price available on request.

Bold Cat.Nos are products normally available with Legrand (India) Stockists. Cat.Nos that are not bold - delivery within 4 - 8 weeks from the date of order. Bold packing quantity is our mandatory packing. Orders to be placed by Legrand (India) Stockist in multiples of the same.

## DPX<sup>3</sup> MCCB

### DPX<sup>3</sup> MCCB with Electronic Sg (LSIg) & Energy Metering Protection Unit

- Range: 250A – 1600A, Ics=100%Icu, Two Optimum Frames
- Protection against Overloads:
  - Ir adjustable from 0.4 to 1 x In
  - tr adjustable from 3 to 30s
- Protection against Short Circuits:
  - Isd adjustable from 1.5 to 10 x Ir
  - tsd adjustable from 0 to 0.5s
- Inbuilt Instantaneous Protection:
  - li – Fixed
- Protection against Ground Fault:
  - Ig adjustable from 0.2 to 1 In & OFF
  - tg adjustable from 0.1 to 1s
- Breaking Capacity – 36kA, 50kA, 70kA & 100kA
- Integrated energy metering with accuracy class 2
- Measure for currents, voltage, frequency, power, energy and harmonics
- Internal Battery with battery measure function
- Communication Ready via COMM Port
- Logical Selectivity Ready (Zone Selective Interlocking)
- Dynamic Selectivity as per Selectivity Charts
- In Built USB Port for Software Diagnosis
- Switchable Thermal Memory
- Suitable for Isolation

Category	Type	Rated Current (A)	3P			4P		
			Cat.Nos	MRP*/₹/Unit	Pack	Cat.Nos	MRP*/₹/Unit	Pack

#### Electronic Sg + Energy Metering

36 KA	DPX <sup>3</sup> 630	320	4221 77	■	1	4221 82	■	1
		400	4221 78	■	1	4221 83	■	1
		500	4221 79	■	1	4221 84	■	1
		630	4221 80	■	1	4221 85	■	1
	DPX <sup>3</sup> 1600	800	4224 44	■	1	4224 50	■	1
		1000	4224 45	■	1	4224 51	■	1
		1250	4224 46	■	1	4224 52	■	1
		1600	4224 47	■	1	4224 53	■	1
50 KA	DPX <sup>3</sup> 630	320	4221 87	■	1	4221 92	■	1
		400	4221 88	■	1	4221 93	■	1
		500	4221 89	■	1	4221 94	■	1
		630	4221 90	■	1	4221 95	■	1
	DPX <sup>3</sup> 1600	800	4224 56	■	1	4224 62	■	1
		1000	4224 57	■	1	4224 63	■	1
		1250	4224 58	■	1	4224 64	■	1
		1600	4224 59	■	1	4224 65	■	1
70 KA	DPX <sup>3</sup> 630	320	4221 97	■	1	4222 02	■	1
		400	4221 98	■	1	4222 03	■	1
		500	4221 99	■	1	4222 04	■	1
		630	4222 00	■	1	4222 05	■	1
	DPX <sup>3</sup> 1600	800	4224 68	■	1	4224 74	■	1
		1000	4224 69	■	1	4224 75	■	1
		1250	4224 70	■	1	4224 76	■	1
		1600	4224 71	■	1	4224 77	■	1

#### Switch Disconnector

DPX <sup>3</sup> 160	160	4201 98	12980	1	4201 99	16310	1
	250	4202 99	25340	1	4203 00	34850	1
DPX <sup>3</sup> 630	400	4222 16	36540	1	4222 18	46700	1
	630	4222 17	42250	1	4222 19	58580	1
DPX <sup>3</sup> 1600	800	4224 91	■	1	4224 95	■	1
	1250	4224 92	■	1	4224 96	■	1
	1600	4224 93	■	1	4224 97	■	1

■ Price available on request.

\* MRP - Maximum Retail Price Inclusive of all taxes including GST.

Bold Cat.Nos are products normally available with Legrand (India) Stockists. Cat.Nos that are not bold - delivery within 4 - 8 weeks from the date of order. Bold packing quantity is our mandatory packing. Orders to be placed by Legrand (India) Stockist in multiples of the same.

## DPX<sup>3</sup> MCCB

Category	Type	Rated Current (A)	3P			4P		
			Cat.Nos	MRP*/₹/Unit	Pack	Cat.Nos	MRP*/₹/Unit	Pack

### Only Magnetic

16 KA	DPX <sup>3</sup> 160	16	4207 10	18800	1	■	■	■
		25	4207 11	18800	1	■	■	■
		50	4207 12	18800	1	■	■	■
		63	4207 13	18800	1	■	■	■
25 KA	DPX <sup>3</sup> 160	16	4207 14	21380	1	■	■	■
		25	4207 15	21380	1	■	■	■
		50	4207 16	21380	1	■	■	■
		63	4207 17	21380	1	■	■	■
36 KA	DPX <sup>3</sup> 250	100	4207 18	37160	1	■	■	■
		160	4207 19	37160	1	■	■	■
		200	4207 20	39300	1	■	■	■
		250	4207 21	41420	1	■	■	■
70 KA	DPX <sup>3</sup> 250	100	4207 22	36320	1	■	■	■
		160	4207 23	36320	1	■	■	■
		200	4207 24	38590	1	■	■	■
		250	4207 25	40860	1	■	■	■

### Accessories

Type	Rotary handle				Shunt release											
	Direct		Vary depth		12 V		24 V		48 V		110 V		230 V		400 V	
	Cat.No	MRP	Cat.No	MRP	Cat.No	MRP	Cat.No	MRP	Cat.No	MRP	Cat.No	MRP	Cat.No	MRP	Cat.No	MRP
DPX <sup>3</sup> 160 DPX <sup>3</sup> 250	4201 60	1850	4201 61	2680	4210 12	3600	4210 13	3600	4210 14	3600	4210 15	3600	4210 16	3600	4210 17	3600
DPX <sup>3</sup> 630	4201 62	2960	4201 63	5090												
DPX <sup>3</sup> 1600	0262 61	6200	0262 83	9520	-	-	4222 39	3830	4222 40	3570	4222 41	3570	4222 42	3830	4222 43	3830

Type	U/V release													
	12 V		24 V		48 V		110 V		230 V		400 V		480 V	
	Cat.No	MRP	Cat.No	MRP	Cat.No	MRP	Cat.No	MRP	Cat.No	MRP	Cat.No	MRP	Cat.No	MRP
DPX <sup>3</sup> 160 DPX <sup>3</sup> 250	4210 18	4510	4210 19	4510	4210 20	4510	4210 21	4460	4210 22	4460	4210 24	4460	4210 25	4460
DPX <sup>3</sup> 630 DPX <sup>3</sup> 1600	-	-	4222 45	5060	4222 46	5060	4222 47	5020	4222 48	5380	4222 49	5380	-	-

Type	Rated Current (A)	Spreaders**				Motor Operator									
		3P (Set of 3)		4P (Set of 4)		24-230V Side		24V		48V		110V		230V	
		Cat.No	MRP	Cat.No	MRP	Cat.No	MRP	Cat.No	MRP	Cat.No	MRP	Cat.No	MRP	Cat.No	MRP
DPX <sup>3</sup> 160		6250 02	1020	6250 06	1380										
DPX <sup>3</sup> 250		6250 14	1020	6250 18	1380	4210 60	50880	4210 61	45700	4210 61	45700	4210 61	45700	4210 61	45700
DPX <sup>3</sup> 630	Upto 400 A	4226 31	2060	4226 32	2750										
	630 A	6250 04	2450	6250 08	3140	-	-	0261 40	78130	0261 41	78130	-	-	0261 44	74410
DPX <sup>3</sup> 1600	Upto 1250 A	4226 24	14710	4226 25	17870	-	-	0261 24	■	0261 25	■	0261 26	79700	0261 23	86160
	1600 A	0262 73	38340	0262 74	40440	-	-	0261 19	■	0261 28	■	0261 29	■	0261 27	81180

\* MRP - Maximum Retail Price Inclusive of all taxes including GST.  
 ■ Price available on request.

Bold Cat.Nos are products normally available with Legrand (India) Stockists.  
 Cat.Nos that are not bold - delivery within 4 - 8 weeks from the date of order.  
 Bold packing quantity is our mandatory packing. Orders to be placed by Legrand (India) Stockist in multiples of the same.

## DPX<sup>3</sup> 160 Equipment & Mounting Accessories

Cat.Nos	Description	MRP* ₹ / Unit	Pack
---------	-------------	------------------	------

### Equipment for Plug-in Version

4210 40	For DPX <sup>3</sup> 160 - 3P	30520	1
4210 41	For DPX <sup>3</sup> 160 - 4P with or without earth leakage module	40910	1
4210 44	Set of connectors for auxiliary contacts	4370	1
4210 45	Key barrel and flat key for Padlocks	27860	1
4210 46	Key barrel and star key for Padlocks	25220	1
4210 47	Padlock accessory	7740	1

### Connection Accessories

4210 26	Set of 3 terminals for High capacity cage terminals	11620	1
4210 27	Set of 4 terminals for High capacity cage terminals	15350	1
4210 70	Set of 3 Insulated Shields/ Phase barriers	250	1
4210 28	Set of 3 terminals Screw terminals for copper bars connection	1320	1
4210 29	Set of 4 terminals Screw terminals for copper bars connection	1370	1
6250 02	Set of 3 spreaders for DPX <sup>3</sup> 160 3P	1020	1
6250 06	Set of 4 spreaders for DPX <sup>3</sup> 160 4P	1380	1

### Connection Accessories

4210 36	Set of 3 rear terminals for DPX <sup>3</sup> 160 3P	6220	1
4210 37	Set of 4 rear terminals for DPX <sup>3</sup> 160 4P	8330	1

### Sealable terminal shields

#### For Front Terminals

4210 54	For DPX <sup>3</sup> 160 3P	6790	1
4210 55	For DPX <sup>3</sup> 160 3P	7150	1

#### For Rear Terminals

4210 50	For DPX <sup>3</sup> 160 3P	4280	1
4210 51	For DPX <sup>3</sup> 160 4P	3800	1

### Fixing Plates

4210 71	For DPX <sup>3</sup> 160 3P / 4P without earth leakage module	620	1
4210 73	For DPX <sup>3</sup> 160 4P with earth leakage module	1540	1
4210 68	For DPX <sup>3</sup> 160 3P / 4P with side mounting motor operator	1570	1

■ Price available on request.

\* MRP - Maximum Retail Price Inclusive of all taxes including GST.



4210 40



4210 36

## DPX<sup>3</sup> 160 and 250 Common Auxiliaries & Accessories

Cat.Nos	Description	MRP* ₹ / Unit	Pack
---------	-------------	------------------	------

### Supply Inverter Type

4210 58	For fixed version	5720	1
4210 59	For plug-in and draw-out version	6100	1

### Rotary Handles

4201 60	Standard handle for thermal magnetic DPX <sup>3</sup>	1850	1
4201 61	Vari-depth standard handles	2680	1
4201 67	Key Lock for VD RH DPX <sup>3</sup> 160 & 250	3260	1
4201 65	Key Lock for DIR RH Type A DPX <sup>3</sup> 160 & 250	3160	1
4201 68	Key Lock for VD RH Type A DPX <sup>3</sup> 160 & 250	3260	1
4201 66	Key Lock for DIR RH Type B DPX <sup>3</sup> 160 & 250	3160	1
4201 69	Key Lock for VD RH Type B DPX <sup>3</sup> 160 & 250	3260	1

### Motor-Driven Handles

4210 60	Side motor operator	50880	1
4210 61	Front motor operator	45700	1
4210 62	Ronis key barrel for front motor operator	10440	1
4210 63	Profalux key barrel for front motor operator	24800	1

## DPX<sup>3</sup> 160 and 250 common Auxiliaries & Accessories

4210 64	Padlock for front motor operator	3540	1
4210 65	Ronis key barrel for side motor operator	27540	1
4210 66	Profalux key barrel for side motor operator	25020	1
4210 67	Padlock for side motor operator	3760	1

### Auxiliary Contacts

4210 10	1 N/C + 1 N/O auxiliary contact for rotary handles	2080	1
4210 11	Auxiliary contact or fault signalling contact	1620	1
4210 48	Signalling contact plugged-in/drawn-out (for DPX <sup>3</sup> plug-in version)	1740	1

### Locking Accessory

4210 49	Padlock for locking in "open" position	28420	1
---------	---	-------	---

### Communication Interface

4210 75	Modbus	23510	1
---------	--------	-------	---



4210 58



4210 10



4210 11

Bold Cat.Nos are products normally available with Legrand (India) Stockists. Cat.Nos that are not bold - delivery within 4 - 8 weeks from the date of order. Bold packing quantity is our mandatory packing. Orders to be placed by Legrand (India) Stockist in multiples of the same.

## DPX<sup>3</sup> 250 Equipment & Mounting Accessories

Cat.Nos	Description	MRP* ₹ / Unit	Pack
---------	-------------	------------------	------

### Equipment for Plug-in Version

4210 42	For DPX <sup>3</sup> 250 - 3P	34180	1
4210 43	For DPX <sup>3</sup> 250 - 4P with or without earth leakage module	41170	1
4210 44	Set of connectors for auxiliary contacts	4370	1
4210 45	Key barrel and flat key N° ABA90GEL6149 for Padlocks	27860	1
4210 46	Key barrel and star key N° HBA90GPS6149 for Padlocks	25220	1
4210 47	Padlock accessory	7740	1

### Connection Accessories

4210 30	Set of 3 cage terminals	4680	1
4210 31	Set of 4 cage terminals	6100	1
4210 70	Set of 3 phase barriers	250	1

### Connection Accessories

6250 14	Set of 3 spreaders for DPX <sup>3</sup> 250 3P	1020	1
6250 18	Set of 4 spreaders for DPX <sup>3</sup> 250 4P	1380	1
4210 38	Set of 3 rear terminals for DPX <sup>3</sup> 250 3P	6280	1
4210 39	Set of 4 rear terminals for DPX <sup>3</sup> 250 4P	8450	1

### Sealable Terminal Shields

#### For Front Terminals

4210 56	For DPX <sup>3</sup> 250 3P	7020	1
4210 57	For DPX <sup>3</sup> 250 4P	7440	1

#### For Rear Terminals

4210 52	For DPX <sup>3</sup> 250 3P	4190	1
4210 53	For DPX <sup>3</sup> 250 4P	4610	1

### Fixing Plates

4210 72	For DPX <sup>3</sup> 250 3P / 4P without earth leakage module	620	1
4210 74	For DPX <sup>3</sup> 250 4P with earth leakage module	2660	1
4210 69	For DPX <sup>3</sup> 250 3P / 4P with side mounting motor operator	1560	1

## DPX<sup>3</sup> 630 Equipment & Accessories

### Plug-in Version

4222 20	Set of incoming and outgoing terminals - 3P (6 terminals for 3P DPX <sup>3</sup> or 8 terminals for 4P DPX <sup>3</sup> )	5570	1
---------	---	------	---

## DPX<sup>3</sup> 630 Equipment & Accessories

Cat.Nos	Description	MRP* ₹ / Unit	Pack
---------	-------------	------------------	------

### Plug-in Version

4222 21	Set of incoming and outgoing terminals - 4P (6 terminals for 3P DPX <sup>3</sup> or 8 terminals for 4P DPX <sup>3</sup> )	6500	1
4222 22	Front terminal mounting base for DPX <sup>3</sup> only - 3P	12980	1
4222 24	Flat rear terminal mounting base for DPX <sup>3</sup> only - 3P	20220	1
4222 23	Front terminal mounting base for DPX <sup>3</sup> only - 4P	16250	1
4222 25	Flat rear terminal mounting base for DPX <sup>3</sup> only - 4P	40120	1
4222 26	Front terminal mounting base for DPX <sup>3</sup> with earth leakage module - 4 P	■	1
4222 27	Flat rear terminal mounting base for DPX <sup>3</sup> with earth leakage module - 4P	■	1
4222 37	For fixing the signalling contact - 4P Cat.No 0265 74 on a DPX <sup>3</sup> plug-in version	4320	1
4222 28	Set of 2 extractor handle	6060	1
4222 29	Set of connectors (24-pin)	3400	1

### Draw-out Version

4222 31	"Debro-lift" mechanism for DPX <sup>3</sup> base only - 3P	39860	1
4222 32	"Debro-lift" mechanism for DPX <sup>3</sup> base only - 4P	41740	1
4222 33	"Debro-lift" mechanism for DPX <sup>3</sup> base with elm - 4P	■	1
0265 76	One key for "Debro-lift" mechanism for DPX <sup>3</sup> only - Flat key	■	1
0265 78	Two keys (one key supplied) for "Debro-lift" mechanism for motorised DPX <sup>3</sup> or with rotary handle - Flat key	■	1
0263 48	One key for "Debro-lift" mechanism for DPX <sup>3</sup> only - Star key	■	1
0265 77	Two keys (one key supplied) for motorised DPX <sup>3</sup> or with rotary handle - Star key	■	1
0265 75	Handle for drawing-out for "Debro-lift" mechanism	6400	1
0265 74	Signalling contact (plugged-in/drawn-out) for "Debro-lift" mechanism	4360	1
4222 36	For fixing the signalling contact Cat.No 0265 74 on a DPX <sup>3</sup> draw-out version	4360	1

■ Price available on request.

\* MRP - Maximum Retail Price inclusive of all taxes including GST.

Bold Cat.Nos are products normally available with Legrand (India) Stockists. Cat.Nos that are not bold - delivery within 4 - 8 weeks from the date of order. Bold packing quantity is our mandatory packing. Orders to be placed by Legrand (India) Stockist in multiples of the same.

## DPX<sup>3</sup> 630

### Equipment & Accessories

Cat.Nos	Description	MRP* ₹ / Unit	Pack
---------	-------------	------------------	------

#### Draw-out Version

4222 30	Block of 6 automatic auxiliary contacts for DPX <sup>3</sup> draw-out version (up to 2 blocks by DPX <sup>3</sup> )	1660	1
---------	---	------	---

#### Supply inverter type

0264 09	Plate for MCCB or trip-free switch fixed version	13930	1
0264 04	Plate for MCCB or trip-free switch plug-in and draw-out version	18800	1

#### Rotary Handles

4201 62	Direct rotary handle	2960	1
4201 63	Vari-depth rotary handle	5090	1
4201 70	Key Lock for VD RH DPX <sup>3</sup> 630	3540	1
4201 71	Key Lock for VD RH Type A DPX <sup>3</sup> 630	3540	1
4201 72	Key Lock for VD RH Type B DPX <sup>3</sup> 630	3540	1

#### Motor-Driven Handles

0261 40	Front operated 24 V~/=	78130	1
0261 41	Front operated 48 V~/=	78130	1
0261 44	Front operated 230 V~	74410	1
422806	Lock and flat key	■	1
0261 58	Lock and star key	19980	1

#### Accessories

0262 30	Set of 3 Insulated Shields/ Phase barriers	310	1
0262 44	Set of 2 sealable terminal shields - 3P	8664	1
0262 45	Set of 2 sealable terminal shields - 4P	2420	1
0262 40	Padlock for locking in "OPEN" position - 4P	3130	1
0262 46	Set of 4 adaptors + Insulated Shields/ Phase barriers for lug - 4P	■	1
0262 47	Set of 4 extended front terminals-4P	8570	1
6250 04	Set of incoming or outgoing spreaders - 3P	2450	1
6250 08	Set of incoming or outgoing spreaders - 4P	3140	1
0263 50	Set of incoming or outgoing swivel rear terminals - 3P	■	1
0263 52	Set of incoming or outgoing flat rear terminals - 3P	27660	1
0263 51	Set of incoming or outgoing swivel terminals - 4P	■	1
0263 53	Set of incoming or outgoing flat terminals - 4P	23490	1
4222 34	Set of 2 IP 20 terminal covers - 3P	1850	1
4222 35	Set of 2 IP 20 terminal covers - 4P	6410	1



0261 40



6250 04



4222 34

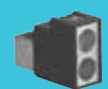

4222 35

■ Price available on request.

\* MRP - Maximum Retail Price inclusive of all taxes including GST.

## DPX<sup>3</sup> 630

### Earth Leakage Module

Type and frame size	Rated Current (A)	Poles	Cat.Nos	MRP* ₹ / Unit	Pack
---------------------	-------------------	-------	---------	------------------	------

#### Earth Leakage Module

##### Standard

DPX <sup>3</sup> 630	400 A	3 Pole	0260 60	50430	1
	630 A	3 Pole	0260 64	94510	1
	400 A	4 Pole	0260 61	89090	1
	630 A	4 Pole	0260 65	93900	1

##### LED Version

DPX <sup>3</sup> 630	400 A	4 Pole	0260 63	■	1
	630 A	4 Pole	0260 67	92000	1

## DPX<sup>3</sup> 1600

### Equipment & Accessories

Cat.Nos	Description	MRP* ₹ / Unit	Pack
---------	-------------	------------------	------

#### Draw-out Version

4225 86	Front terminals - 3P	■	1
4225 88	Rear terminals - 3P	■	1
4225 87	Front terminals - 4P	■	1
4225 89	Rear terminals - 4P	■	1
4225 93	Debro-lift mechanism For DPX <sup>3</sup> 1600 - 3P	■	1
4225 94	Debro-lift mechanism for DPX <sup>3</sup> 1600 - 4P	■	1
4225 95	For fixing the signalling contact Cat.No 0265 74 on a DPX <sup>3</sup> draw-out version	■	1
0265 76	One key for "Debro-lift" mechanism for DPX <sup>3</sup> only - Flat key	■	1
0265 80	Two key (one key supplied) for motorised DPX <sup>3</sup> or with rotary handle	■	1
0263 48	One key for DPX <sup>3</sup> only - Starkey	■	1
0265 79	Two key (one key supplied) for motorised DPX <sup>3</sup> or with rotary handle	■	1
0265 75	Handle for drawing-out for "Debro-lift" mechanism	6400	1
0265 74	Signalling contact (plugged-in/drawn-out)	4360	1
4222 30	Block of 6 automatic auxiliary contacts for DPX <sup>3</sup> draw-out version (up to 2 blocks by DPX <sup>3</sup> )	1660	1



4225 88 + 4225 93

Bold Cat.Nos are products normally available with Legrand (India) Stockists. Cat.Nos that are not bold - delivery within 4 - 8 weeks from the date of order. Bold packing quantity is our mandatory packing. Orders to be placed by Legrand (India) Stockist in multiples of the same.

## DPX<sup>3</sup> 1600

### Equipment & Accessories

Cat.Nos	Description	MRP* ₹ / Unit	Pack
---------	-------------	------------------	------

#### Supply Inverter Type

0264 10	Plate for MCCBs or trip-free switch fixed version	16880	1
0264 05	Plate for MCCBs or trip-free switch plug-in and draw-out version	■	1

#### Rotary Handles

0262 61	Standard (black) direct on DPX <sup>3</sup>	6200	1
0262 83	Standard (black) vari-depth handle IP 55	9520	1
0262 93	Key barrel and flat key	3530	1
0262 94	Key barrel and star key	18200	1

#### Motor-Driven Handles

0261 54	Front operated 230 V±	101280	1
0261 24	Front operated 24 V±/= for In ≤ 1250 A	■	1
0261 25	Front operated 48 V±/= for In ≤ 1250 A	■	1

#### Motor-Driven Handles

0261 26	Front operated 110 V±/= for In ≤ 1250 A	79700	1
0261 23	Front operated 230 V±/= for In ≤ 1250 A	86160	1
0261 19	Front operated 24 V±/= for In = 1600 A	■	1
0261 28	Front operated 48 V±/= for In = 1600 A	■	1
0261 29	Front operated 110 V±/= for In = 1600 A	■	1
0261 27	Front operated 230 V±/= for In = 1600 A	81180	1
4228 06	Mech Support DPX <sup>3</sup> 630/1600 Key lock	10990	1
0261 58	Key and star key	19980	1

#### Accessories

0262 66	Set of 3 Insulated Shields/ Phase barriers	600	1
0262 64	Set of 2 sealable terminal shields - 3P	■	1
0262 65	Set of 2 sealable terminal shields - 4P	3250	1
0262 60	Padlock for locking in "open" position	2810	1
0262 67	Set of 4 extended front short terminals for 630 - 1250 A (2 bars max. per pole)	■	1



0262 60

■ Price available on request.

\* MRP - Maximum Retail Price Inclusive of all taxes including GST.

## DPX<sup>3</sup> 630 and 1600

### Common Auxiliaries

Cat.Nos	Description	MRP* ₹ / Unit	Pack
---------	-------------	------------------	------

#### Accessories

0262 68	Set of 4 extended front Long terminals for 1600 A (3 bars max. per pole)	27690	1
4226 24	Set of incoming or outgoing spreaders for 800 A & 1000 A - 3P	14710	1
4226 25	Set of incoming or outgoing spreaders for 800 A & 1000 A - 4P	17870	1
0262 73	Set of incoming or outgoing spreaders for 1250 A & 1600 A - 3P	38340	1
0262 74	Set of incoming or outgoing spreaders for 1250 A & 1600 A - 4P	40440	1
0263 80	Short rear terminals - 3P	■	1
0263 81	Long rear terminals - 3P	■	1
0263 82	Short rear terminals - 4P	■	1
0263 83	Long rear terminals - 4P	■	1
4225 90	Set of 2 IP 20 terminal covers - 3P	2050	1
4225 91	Set of 2 IP 20 terminal covers - 4P	3330	1
4225 92	External neutral - 4P	21750	1



0262 67 + 0262 68

#### Common Auxiliaries

4210 11	For signalling the state of the contacts or opening of the MCCB on a fault For DPX <sup>3</sup> /DPX <sup>3</sup> -I Changeover switch 3 A - 240 V±	1620	1
---------	---	------	---

#### Releases

Allow remote tripping of a DPX<sup>3</sup>

#### Time-lag undervoltage releases (800 ms)

Prevent false tripping in the event of power supply microbreaks.

Require a time-lag module connected to the undervoltage release Cat.No 4226 23

0261 90	Time-lag module 230 VA 3 module	■	1
---------	---------------------------------	---	---

Bold Cat.Nos are products normally available with Legrand (India) Stockists. Cat.Nos that are not bold - delivery within 4 - 8 weeks from the date of order. Bold packing quantity is our mandatory packing. Orders to be placed by Legrand (India) Stockist in multiples of the same.

## DPX<sup>3</sup> 630 and 1600

### Common Auxiliaries

Cat.Nos	Description	MRP* ₹ / Unit	Pack
---------	-------------	---------------------	------

#### Releases

0261 91	Time-lag module 400 VA	■	1
4226 23	Undervoltage release for DPX <sup>3</sup> 630 and 1600	■	1

#### Auto Transfer Controller

4226 81	Standard unit	45720	1
4226 82	Advanced unit	53350	1
4226 89	Communication module	14300	1



4226 82



0260 88

#### Residual Current Relay

0260 88	Residual current relay to clip on module 2 rail	31960	1
---------	--	-------	---

#### Current Transformer

0260 92	Coil Ø35 mm	17450	1
0260 93	Coil Ø80 mm	25460	1
0260 94	Coil Ø110 mm	39250	1
0260 95	Coil Ø140 mm	41300	1
0260 96	Coil Ø210 mm	70450	1
0260 97	Coil Ø150 mm - open	■	1
0260 98	Coil Ø300 mm - open	■	1



0260 93  
coil for use  
with relay



0260 98

#### Metal One Way Enclosures for MCCB

Cat.Nos	Description	No. of modules	MRP* ₹ / Unit	Pack
---------	-------------	-------------------	---------------------	------

5078 01	DPX <sup>3</sup> 160 MCCB enclosure	3&4	6242	1
5078 02	DPX <sup>3</sup> 250 MCCB enclosure	3&4	10976	1
5078 04	DPX <sup>3</sup> 630 MCCB enclosure	3&4	17050	1

■ Price available on request.

\* MRP - Maximum Retail Price Inclusive of all taxes including GST.

# DRX

## MCCB RANGE

### Powerful Protection, Compact Design Engineered for Enduring Safety



The DRX MCCB range delivers dependable circuit protection with a robust design and a wide range of accessories. Engineered for efficiency and affordability, it offers adjustable protection settings and advanced safety features to safeguard electrical installations across industrial and commercial applications up to 630A.

### Features

- Accurate performance at higher temperatures with no deration up to 50°C
- Adjustable protection settings with overload and pre-alarm indication
- Integrated contact module for status indication and monitoring
- In-built neutral protection available in 4-pole configuration

### Benefits

- Ensures reliable circuit protection even in demanding environments
- Enables flexible configuration for different electrical protection needs
- Improves monitoring and operational visibility of electrical systems
- Provides enhanced safety and protection for electrical installations



## A COMPREHENSIVE RANGE

The robust design of DRX MCCB offer adjustable protection, different accessories for connection and remote tripping. They are the ideal choice in terms of efficiency and affordability for protection of your electrical installations of up to 630A.



QCO Certified

Scan to know more about the product.



## DRX MCCB

### DRX MCCB with Thermal Magnetic Protection Unit

Range – 16A to 630A

Ics = 100% Icu

Thermal Adjustable – 0.8 to 1 In

Magnetic Setting – 10 In for DRX125HP

Magnetic Setting – Adjustable 5 to 10 In for DRX250HP and DRX630

Suitable for Isolation

Category	Type	Rated Current (A)	3P			4P		
			Cat.Nos	MRP*/₹/Unit	Pack	Cat.Nos	MRP*/₹/Unit	Pack

#### Thermal Magnetic : O/L & S/C Protection

25 KA	DRX 125 <sup>HP</sup>	16	6697 00	10260	1	6697 10	14270	1
		20	6697 01	10260	1	6697 11	14270	1
		25	6697 02	10260	1	6697 12	14270	1
		32	6697 03	10260	1	6697 13	14270	1
		40	6697 04	10260	1	6697 14	14270	1
		50	6697 05	10260	1	6697 15	14270	1
		63	6697 06	10260	1	6697 16	14270	1
		80	6697 07	10260	1	6697 17	14270	1
		100	6697 08	10260	1	6697 18	14270	1
		125	6697 09	15200	1	6697 19	18030	1
36 KA	DRX 125 <sup>HP</sup>	16	6697 20	13360	1	6697 30	16660	1
		20	6697 21	13360	1	6697 31	16660	1
		25	6697 22	13360	1	6697 32	16660	1
		32	6697 23	13360	1	6697 33	16660	1
		40	6697 24	13360	1	6697 34	16660	1
		50	6697 25	13360	1	6697 35	16660	1
		63	6697 26	13360	1	6697 36	16660	1
		80	6697 27	13360	1	6697 37	16660	1
		100	6697 28	13360	1	6697 38	16660	1
		125	6697 29	15380	1	6697 39	19400	1
50 KA	DRX 125 <sup>HP</sup>	16	6697 40	17080	1	6697 50	21520	1
		20	6697 41	17080	1	6697 51	21520	1
		25	6697 42	17080	1	6697 52	21520	1
		32	6697 43	17080	1	6697 53	21520	1
		40	6697 44	17080	1	6697 54	21520	1
		50	6697 45	17080	1	6697 55	21520	1
		63	6697 46	17080	1	6697 56	21520	1
		80	6697 47	17080	1	6697 57	21520	1
		100	6697 48	17080	1	6697 58	21520	1
		125	6697 49	22380	1	6697 59	25780	1

\* MRP - Maximum Retail Price Inclusive of all taxes including GST.

Bold Cat.Nos are products normally available with Legrand (India) Stockists. Cat.Nos that are not bold - delivery within 4 - 8 weeks from the date of order. Bold packing quantity is our mandatory packing. Orders to be placed by Legrand (India) Stockist in multiples of the same.

## DRX MCCB

### DRX MCCB with Thermal Magnetic Protection Unit

Category	Type	Rated Current (A)	3P			4P		
			Cat.Nos	MRP*/₹/Unit	Pack	Cat.Nos	MRP*/₹/Unit	Pack

#### Thermal Magnetic : O/L & S/C Protection

25 KA	DRX 250 <sup>HP</sup>	16	6690 00	■	1	6690 20	■	1
		20	6690 01	■	1	6690 21	■	1
		25	6690 02	■	1	6690 22	■	1
		32	6690 03	■	1	6690 23	■	1
		40	6690 04	15500	1	6690 24	18890	1
		50	6690 05	15500	1	6690 25	18890	1
		63	6690 06	15500	1	6690 26	18890	1
		80	6690 07	15500	1	6690 27	18890	1
		100	6690 08	16320	1	6690 28	19830	1
		125	6690 09	17230	1	6690 29	21310	1
		160	6690 10	21750	1	6690 30	25230	1
		200	6690 11	24760	1	6690 31	30350	1
250	6690 12	28800	1	6690 32	34450	1		
36 KA	DRX 250 <sup>HP</sup>	16	6690 40	■	1	6690 60	■	1
		20	6690 41	■	1	6690 61	■	1
		25	6690 42	■	1	6690 62	■	1
		32	6690 43	■	1	6690 63	■	1
		40	6690 44	15970	1	6690 64	19680	1
		50	6690 45	15970	1	6690 65	19680	1
		63	6690 46	15970	1	6690 66	19680	1
		80	6690 47	15970	1	6690 67	19680	1
		100	6690 48	16770	1	6690 68	20640	1
		125	6690 49	18830	1	6690 69	22090	1
		160	6690 50	21980	1	6690 70	25560	1
		200	6690 51	27200	1	6690 71	35130	1
	250	6690 52	31140	1	6690 72	37520	1	
	DRX 630	320	6676 50	38380	1	6676 54	46740	1
		400	6676 51	38380	1	6676 55	47610	1
		500	6676 52	49470	1	6676 56	62260	1
630		6676 53	49470	1	6676 57	65230	1	



6676 51

■ Price available on request.

\* MRP - Maximum Retail Price Inclusive of all taxes including GST.

Bold Cat.Nos are products normally available with Legrand (India) Stockists. Cat.Nos that are not bold - delivery within 4 - 8 weeks from the date of order. Bold packing quantity is our mandatory packing. Orders to be placed by Legrand (India) Stockist in multiples of the same.

## DRX MCCB

### DRX MCCB with Thermal Magnetic Protection Unit

Category	Type	Rated Current (A)	3P			4P		
			Cat.Nos	MRP*/₹/Unit	Pack	Cat.Nos	MRP*/₹/Unit	Pack

#### Thermal Magnetic : O/L & S/C Protection

50 KA	DRX 250 <sup>HP</sup>	16	6690 80	■	1	6691 00	■	1
		20	6690 81	■	1	6691 01	■	1
		25	6690 82	■	1	6691 02	■	1
		32	6690 83	■	1	6691 03	■	1
		40	6690 84	22540	1	6691 04	27090	1
		50	6690 85	22540	1	6691 05	27120	1
		63	6690 86	22540	1	6691 06	27120	1
		80	6690 87	22540	1	6691 07	27120	1
		100	6690 88	23670	1	6691 08	28470	1
		125	6690 89	24550	1	6691 09	29560	1
		160	6690 90	27430	1	6691 10	31950	1
		200	6690 91	33170	1	6691 11	41270	1
		250	6690 92	35660	1	6691 12	43920	1
		DRX 630	320	6676 58	42250	1	6676 62	53140
400	6676 59		42250	1	6676 63	53140	1	
500	6676 60		59850	1	6676 64	74770	1	
630	6676 61		59850	1	6676 65	74770	1	



6690 92



6676 61

## DRX MCCB

### DRX MCCB with Electronic S2 (LSI) Protection Unit

- Range: 40A – 630A, Ics=100%Icu, Two Optimum Frames
- Protection against overloads:
  - Ir adjustable from 0.4 to 1 x In
  - tr adjustable from 3 to 30s#
- Protection against short circuits:
  - Isd adjustable from 1.5 to 10 x Ir
  - tsd adjustable from 0 to 0.5s
- Inbuilt Instantaneous Protection:
  - li# – Fixed
- Overload Alarm Indication - I > 1.05 Ir
- Pre-Overload Alarm Indication - I > 0.9 Ir
- Over temperature Alarm Indication - T > 90 °C
- Integrated Contact Module (On/Off/ Trip ) for DRX 250HP Electronic MCCBs
- Suitable for Isolation

Category	Type	Rated Current (A)	3P			4P		
			Cat.Nos	MRP*/₹/Unit	Pack	Cat.Nos	MRP*/₹/Unit	Pack

#### Electronic S2

36 KA	DRX 250 <sup>HP</sup>	40	6691 70	23550	1	6691 80	29930	1
		100	6691 71	23550	1	6691 81	29930	1
		160	6691 72	30140	1	6691 82	42160	1
		250	6691 73	41370	1	6691 83	56450	1
	DRX 630	320	6699 01	53390	1	6699 06	65760	1
		400	6699 02	53390	1	6699 07	65760	1
		630	6699 04	59960	1	6699 09	78530	1

\* MRP - Maximum Retail Price Inclusive of all taxes including GST.  
 ■ Price available on request.

Bold Cat.Nos are products normally available with Legrand (India) Stockists. Cat.Nos that are not bold - delivery within 4 - 8 weeks from the date of order. Bold packing quantity is our mandatory packing. Orders to be placed by Legrand (India) Stockist in multiples of the same.

## DRX MCCB

### DRX MCCB with Electronic S2 (LSI) Protection Unit Electronic S2

50 KA	DRX 250 <sup>HP</sup>	40	6691 90	28380	1	6692 00	39190	1
		100	6691 91	28380	1	6692 01	39190	1
		160	6691 92	36870	1	6692 02	48320	1
		250	6691 93	47060	1	6692 03	60280	1
	DRX 630	320	6699 11	58410	1	6699 16	74470	1
		400	6699 12	58410	1	6699 17	74470	1
		630	6699 14	64800	1	6699 19	82970	1

## DRX MCCB

### DRX MCCB with Electronic Sg (LSIg) Protection Unit

- Range: 40A – 630A, Ics=100%Icu, Two Optimum Frames
- Protection against overloads:
  - Ir adjustable from 0.4 to 1 x In
  - tr adjustable from 3 to 30s#
- Protection against short circuits:
  - I<sub>sd</sub> adjustable from 1.5 to 10 x Ir
  - t<sub>sd</sub> adjustable from 0 to 0.5s
- Inbuilt Instantaneous Protection:
  - Ii# – Fixed
- Protection against Ground Fault:
  - Ig adjustable from 0.2 to 1 In & OFF
  - tg adjustable from 0.1 to 1s
- Overload Alarm Indication - I > 1.05 Ir
- Pre-Overload Alarm Indication - I > 0.9 Ir
- Over temperature Alarm Indication - T > 90 °C
- Integrated Contact Module (On/Off/ Trip ) for DRX 250HP Electronic MCCBs
- Suitable for Isolation

Category	Type	Rated Current (A)	3P			4P		
			Cat.Nos	MRP*/₹/Unit	Pack	Cat.Nos	MRP*/₹/Unit	Pack

### Electronic Sg

36 KA	DRX 250 <sup>HP</sup>	40	6691 75	42600	1	6691 85	49520	1
		100	6691 76	42600	1	6691 86	49520	1
		160	6691 77	48530	1	6691 87	59420	1
		250	6691 78	57450	1	6691 88	71300	1
	DRX 630	320	6699 21	72500	1	6699 26	83420	1
		400	6699 22	72500	1	6699 27	83420	1
		630	6699 24	78450	1	6699 29	97040	1
50 KA	DRX 250 <sup>HP</sup>	40	6691 95	46550	1	6692 05	55200	1
		100	6691 96	46550	1	6692 06	55200	1
		160	6691 97	55460	1	6692 07	65860	1
		250	6691 98	62400	1	6692 08	73610	1
	DRX 630	320	6699 31	75030	1	6699 36	90540	1
		400	6699 32	75030	1	6699 37	90540	1
		630	6699 34	80980	1	6699 39	101000	1



6691 98

\* MRP - Maximum Retail Price Inclusive of all taxes including GST.

Bold Cat.Nos are products normally available with Legrand (India) Stockists. Cat.Nos that are not bold - delivery within 4 - 8 weeks from the date of order. Bold packing quantity is our mandatory packing. Orders to be placed by Legrand (India) Stockist in multiples of the same.

### Accessories

Type	Rotary handle					
	Direct			Vary depth		
	Cat.No	MRP	Pack	Cat.No	MRP	Pack
DRX 125HP	6687 70	1530	1	6687 71	2330	1
DRX 250HP	6687 72	1550	1	6687 73	2420	1
DRX 630	6687 80	2750	1	6687 81	4530	1



0271 54



4222 42

Type	Shunt release					
	240V AC			415V AC		
	Cat.No	MRP	Pack	Cat.No	MRP	Pack
DRX 125HP	0271 54	2880	1	0271 55	2880	1
DRX 250HP						
DRX 630	4222 42	■	1	4222 43	■	1



0271 65

Type	Undervoltage					
	240V AC			415V AC		
	Cat.No	MRP	Pack	Cat.No	MRP	Pack
DRX 125HP	0271 64	3990	1	0271 65	3990	1
DRX 250HP						
DRX 630	4222 48	■	1	4222 49	■	1

Type	Rated Current (A)	Spreaders					
		3P One Side			4P One Side		
		Cat.No	MRP	Pack	Cat.No	MRP	Pack
DRX 125HP	125A	6250 10	330	1	6250 11	480	1
DRX 250HP	250A	6250 14	1020	1	6250 18	1380	1
DRX 630	400A	4226 31	2060	1	4226 32	2750	1
	630A	6250 04	2450	1	6250 08	3140	1

Type	Rated Current (A)	Phase Barriers					
		3P One Side			4P One Side		
		Cat.No	MRP	Pack	Cat.No	MRP	Pack
DRX 125HP	125A	6693 00	210	1	6693 01	260	1
DRX 250HP	250A						
DRX 630	400A	0262 30	310	1	0262 30	310	1
	630A						

\* MRP - Maximum Retail Price Inclusive of all taxes including GST.  
 ■ Price available on request.

Bold Cat.Nos are products normally available with Legrand (India) Stockists.  
 Cat.Nos that are not bold - delivery within 4 - 8 weeks from the date of order.  
 Bold packing quantity is our mandatory packing. Orders to be placed by Legrand (India) Stockist in multiples of the same.

### Accessories



0271 80

Type	Rated Current (A)	Padlocks		
		3P One Side		
		Cat.No	MRP	Pack
DRX 125HP	125A	0271 80	2080	1
DRX 250HP	250A			
DRX 630	400A	0262 40	3130	1
	630A			

#### Key Locks

Type		Cat.No	MRP	Pack
For DRX 125HP/250HP for Direct Handle	Random	6687 74	3220	1
	A	6687 75	3220	1
	B	6687 76	3220	1

#### Key Locks

Type		Cat.No	MRP	Pack
For DRX 125HP/250HP for Vary Depth Handle	Random	6687 77	3170	1
	A	6687 78	3170	1
	B	6687 79	3170	1

#### Key Locks

Type		Cat.No	MRP	Pack
For DRX 630 for Vary Depth Handle	Random	6687 82	3170	1
	A	6687 83	3170	1
	B	6687 84	3170	1

#### Auxiliary Contact

	Cat.No	MRP	Pack
DRX 125HP DRX 250HP	0271 40	1330	1
DRX 630	4210 11	■	1

#### Trip Alarm Contact

DRX 125HP DRX 250HP	0271 41	1330	1
DRX 630	4210 11	■	1

#### Trip Alarm Contact

DRX 125HP DRX 250HP	0271 42	2320	1
------------------------	---------	------	---

\* MRP - Maximum Retail Price Inclusive of all taxes including GST.  
■ Price available on request.

### DRX™ MCCB

Type and frame size	Rated Current (A)	Poles	Cat.Nos	MRP* ₹ / Unit	Pack
---------------------	-------------------	-------	---------	---------------	------

#### DRX MCCBs

DRX 100 Icu = 10 kA	63 A	3 Pole	0270 39	4450	1/12
	75 A	3 Pole	0270 07	4450	1/12
	100 A	3 Pole	0270 08	4450	1/12
	125 A	3 Pole	0270 09	5840	1/12
	63 A	4 Pole	0270 29	6410	1/12
	75 A	4 Pole	0270 17	6410	1/12
	100 A	4 Pole	0270 18	6410	1/12
	125 A	4 Pole	0270 19	6890	1/12



0270 08

Description	Cat.Nos	MRP* ₹ / Unit	Pack
-------------	---------	---------------	------

#### Din Rail Adaptor

DRX 100	0271 87	610	1
---------	---------	-----	---

#### Rotary Handles - Direct

DRX 100	6687 70	1530	1
---------	---------	------	---

#### Rotary Handles - Vary-Depth

DRX 100	6687 71	2330	1
---------	---------	------	---

#### Padlocking Support For Operating Handle

DRX 100	0271 80	2080	1
---------	---------	------	---

#### Connection Accessories

Set of 2 shields for 3 pole	0271 81	150	1
-----------------------------	---------	-----	---

#### Sealable Terminal Shields (Moulded Shrouds)

For DRX 100 - 3 pole	0271 83	1990	1
For DRX 100 - 4 pole	0271 84	1860	1



0271 83

#### Cage Terminals

For DRX 100 - 3 pole	0271 71	400	1
For DRX 100 - 4 pole	0271 73	380	1

#### Electrical Accessories

Block with 1 auxiliary (1 AUX)	0271 40	1330	1
Block with 1 alarm (1 AL)	0271 41	1330	1
Block with 1 auxiliary + 1 alarm (1 AUX + 1 AL)	0271 42	2320	1



0271 40

#### Current Shunt Coils

200/277 V~ and =	0271 54	2880	1
380/480 V~ and =	0271 55	2880	1

#### Undervoltage Release Coils

200/240 V~	0271 64	3990	1
380/415 V~	0271 65	3990	1

#### DRX Spreader Links

3 Links set for TP	6250 10	330	1
4 Links set for FP	6250 11	480	1

#### Metal One Way Enclosures For MCCB

Cat.Nos	Description	No. of modules	MRP* ₹ / Unit	Pack
5078 05	DRX 100 MCCB enclosure-TP	3	■	1
5078 06	DRX 100 MCCB enclosure-FP	3	3176	1

\* MRP - Maximum Retail Price Inclusive of all taxes including GST.  
Bold Cat.Nos are products normally available with Legrand (India) Stockists.  
Cat.Nos that are not bold - delivery within 4 - 8 weeks from the date of order.  
Bold packing quantity is our mandatory packing. Orders to be placed by Legrand (India) Stockist in multiples of the same.



0271 40

# CAST RESIN

## Transformers

### High-Efficiency Power Distribution for Critical Installations



Green T.HE cast resin transformers are designed for efficient and reliable power distribution in indoor environments such as data centres, commercial buildings, and critical infrastructure. Engineered to reduce electrical losses and improve operational performance, they support energy-efficient installations while helping lower CO<sub>2</sub> emissions.

#### Features

- Power ratings from 100 kVA to 3150 kVA
- 10% reduced No load losses
- Copper or aluminium windings for flexible performance and cost optimisation
- Designed in compliance with IEC 60076-11 & EN 50708
- E2-C2-F1 Certified

#### Benefits

- High reliability for critical power distribution applications
- Reduced energy losses and operating costs
- Lower maintenance with dry-type transformer construction
- Environmentally responsible solution with reduced lifecycle impact

Scan to know more about the product.



# XL<sup>3</sup> DO

## Smart Switchboard complying IEC61439 1&2

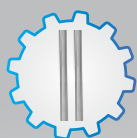

**MECHANICAL STRENGTH**  
 • 5-Fold Uprights  
 • 2mm Load Bearing Member



**DMC Busbar Support**  
 to handle 960° C



**EXTENDABLE PANEL DESIGN**  
 • Complete Bolted design



**Design Ambient**  
 • Designed for 50°C to withstand the harsh Indian conditions



**3-WAY CORNER BLOCK**  
 • Zero welding corners  
 • Higher Life



**Special Hinge design**  
 • Spacious compartment  
 • Easy maintenance



**IP54 /  
IP43**



**Mechanical Impact**  
 • Tested for 1K10



### APPLICATION



Commercial Building



Airports



Data Center



Hospital



Marine & MES



Chemical Industry

# LBPLUS DATA

## High-Efficiency Lighting and Power Distribution



The LB PLUS range is a modular busbar system engineered for high-performance energy distribution in commercial and industrial ceilings. Designed as a plug-and-play alternative to traditional cable trays, it enables scalable power distribution for standard LED lighting as well as advanced smart lighting management.

### Features

- Dual-profile design for standard and long-span installations
- IP55 and IK07 protection for demanding environments
- DATA version supporting DALI and 1–10V lighting control
- Rapid-connect tap-off plugs in 10A, 16A, and 25A options

### Benefits

- Enables flexible power distribution with quick addition or relocation of power points
- Reduces installation time with modular plug-and-play assembly
- Supports energy-efficient lighting through intelligent control systems
- Ensures dependable performance with certified safety and compliance standards

Scan to know more about  
the product.



# RCP IP68

## Resin Cast Busbar

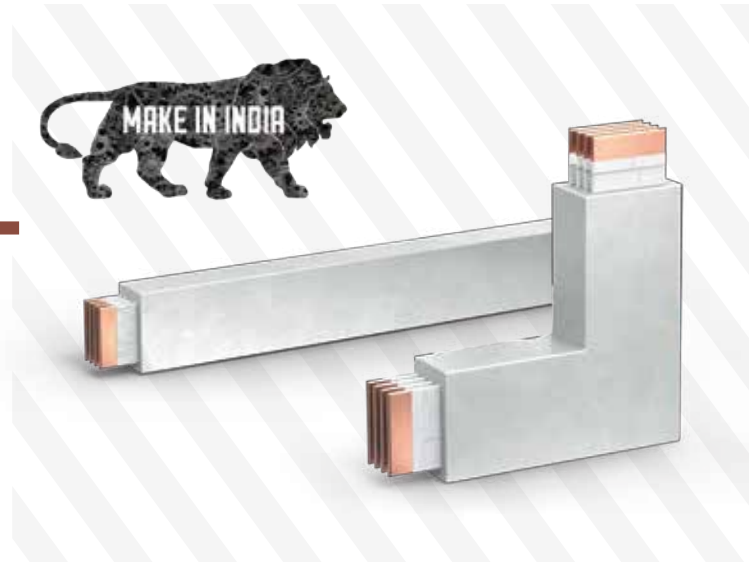

## Reliable High-Power Energy Distribution

The RCP IP68 Resin Busbar Trunking System is engineered for high-power distribution in demanding industrial environments. Its sealed construction ensures reliable operation in areas exposed to moisture, corrosion, or temporary immersion while complying with IEC 61439-6 Busbar Trunking Systems standards.

### Features

- IP68 protection against dust and water immersion
- Current ratings from 630 A to 6300 A for high-power distribution
- Fully encapsulated with Epoxy Resin
- Conductors insulated in polyester film
- Maintenance Free
- Mechanical Impact : IK10

### Benefits

- Ensures reliable power distribution in harsh corrosive environments
- Reduced maintenance due to sealed, durable design
- Optimized for continuous high-current power distribution
- Long service life with robust insulation and mechanical strength

Scan to know more about the product.



# DSX

## Switch Disconnecter & Changeovers

### Safety, Strength & Easy DIN-Rail Installation



DSX DIN Frame 2 is a range of switch disconnectors and transfer switches designed for modern power switching applications. With visible contact separation, pop-up ON/OFF indication, and robust AC23A performance, it ensures safe isolation and dependable operation.

#### Features

- Visible contact separation with pop-up status indication
- Compact DIN-rail or plate mounting design with ratings up to 320 A
- AC23A rated switching performance
- IEC 60947-3 compliant with accessory compatibility

#### Benefits

- Enhances operator safety with clear switching visibility
- Saves panel space with a compact installation footprint
- Ensures reliable switching for demanding load conditions
- Enables flexible installation with Legrand's MCCB and MCB systems



## Range



SD DIN LINE



TSE DIN LINE



SD POWER LINE



TSE POWER LINE

Scan to know more about  
the product.



# DSX

NEW RANGE FOR POWER SWITCHING NEEDS OF MODERN INSTALLATIONS

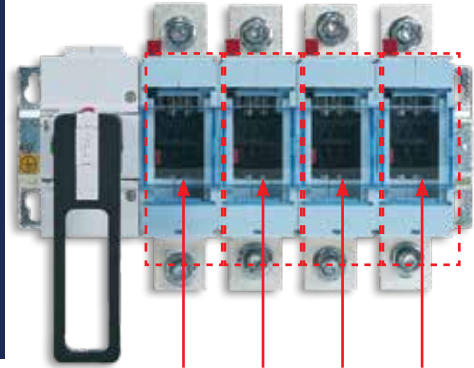

The physical separation of the main contacts is visible through a transparent cover.



Pop up indicators

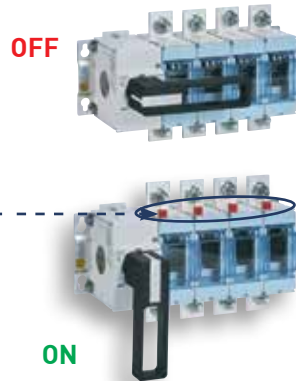

Innovative Design



Safe



Ease of Installation



Robust

## DSX SD/TSE

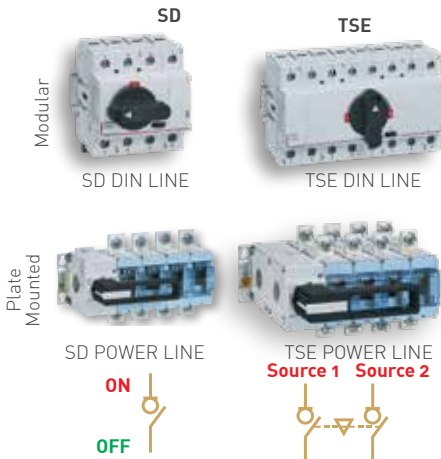

Frame -->	DIN LINE 1	DIN LINE 2	POWER LINE 1	POWER LINE 2
Ratings	32A, 40A, 63A	100A, 125A, 160A	63A, 100A, 125A, 160A	200A, 250A, 320A
Rated Operational Voltage, Ue	690V AC 250V DC	500V AC 250V DC	690V AC 250V DC	690V AC 250V DC
Rated Insulation Voltage, Ui	690V AC	690V AC	1000V AC	
Rated Impulse Voltage, Uimp	8KV	8KV	8KV	12KV
Mechanical Life	10000	7000	10000	10000
Electrical Life	2000	1000	2500	2000
Icw for 1 Sec	1.5KA	2.5KA	8KA	12.5KA

@12000 for DIN LINE 1 SD/ 10000 for DIN LINE 1 TSE

Type	Rated Current (A)	Switch Disconnecter			TSE (Changeover Switch)			TSE (Changeover Switch) with Enclosure		
		Cat.Nos	MRP*/₹/Unit	Pack	Cat.Nos	MRP*/₹/Unit	Pack	Cat.Nos	MRP*/₹/Unit	Pack
DIN Line Frame 1 (3P + N)	32A	4240 06	4040	1	4241 06	7220	1			
	40A	4240 07	4240	1	4241 07	7540	1			
	63A	4240 08	5040	1	4241 08	8800	1			
DIN Line Frame 2 (3P)	100A	4240 03	8260	1	4241 03	■	1			
	125A	4240 04	8500	1	4241 04	■	1			
	160A	4240 05	10620	1	4241 05	■	1			
DIN Line Frame 2 (4P)	100A	4240 09	8730	1	4241 09	17700	1			
	125A	4240 46	9090	1	4241 46	18880	1			
	160A	4240 47	14750	1	4241 47	25960	1			
POWER Line Frame 1 (4P)	63A	4240 82	6020	1	4241 82	10600	1	424192	15790	1
	100A	4240 83	11120	1	4241 83	13310	1	424193	19200	1
	125A	4240 84	13640	1	4241 84	18150	1	424194	22040	1
	160A	4240 85	18410	1	4241 85	20660	1	424195	28400	1
POWER Line Frame 2 (4P)	200A	4240 86	20000	1	4241 86	27620	1	424196	33890	1
	250A	4240 87	23380	1	4241 87	38140	1	424197	45680	1
	320A	4240 88	25820	1	4241 88	39070	1	424198	47870	1

## Accessories

	DIN LINE 1		
	Cat.Nos	MRP*/₹/Unit	Pack
Shorting Links for TSE (set of 4)	4242 01	1120	1
Terminal Shield IP20 - 3P#	4242 02	460	1
Terminal Shield IP20 - 1P#	4242 03	370	1
Auxiliary contact (1 NO + 1 NC)	4242 08	590	1
Vary Depth Handle	4242 09	1650	1
	DIN LINE 2		
	Cat.Nos	MRP*/₹/Unit	Pack
DSX Shorting links ECO Frame 2 (160A) 4P - DIN	4242 12	2360	1
DSX DIN Shorting links 160A 3P	4242 11	2120	1

	POWER LINE 1			POWER LINE 2		
	Cat.Nos	MRP*/₹/Unit	Pack	Cat.Nos	MRP*/₹/Unit	Pack
Auxiliary contact 4 NO + 4NC	4242 45	1650	1	4242 45	1650	1
Aux Contact (1NO+1NC) Early Make/Break	4242 44	1950	1	4242 44	1950	1
Spreaders Terminals (One Side i.e. Set of 4)	4242 54	1300	1	4242 38	2580	1
Terminal Shield IP20 - 4P	4242 47	1320	1	4242 36	1520	1
Phase Barriers	4242 51	260	1	4242 43	330	1
Inter Source Barrier	4242 52	330	1	4242 39	530	1
Shorting Links for TSE (Set of 4)	4242 49	3170	1	4242 41	4770	1
Direct Handle	4242 30	1390	1	4242 30	1390	1
Vary Depth Handle	4242 31	1980	1	4242 31	1980	1
Direct Key Lock	4242 34	1390	1	4242 34	1390	1

# To be Ordered together as 1 set for 4P SD and 2 sets for 4P TSE.

SD POWER LINE --> Packaging Includes SD, Phase Barriers, Vary Depth Handle.

TSE POWER LINE --> Packaging Includes TSE, Phase Barriers, Inter Source Barrier, Vary Depth Handle, Shorting Links.

■ Price available on request.

# EMDX<sup>3</sup>

## Smart Electricity Meters

### Sustainable Energy Savings for your Installations



The EMDX<sup>3</sup> range of smart multifunction meters enables precise energy monitoring for single-phase and three-phase electrical networks. Designed for commercial and industrial applications, the meters support direct or CT connections and integrate with supervision systems

### Features

- Single-phase, three-phase, and CT-based metering options
- MID-certified models with bi-directional energy measurement
- Advanced electrical and power quality monitoring
- Modbus RS-485 and pulse output connectivity

### Benefits

- Improves energy efficiency through accurate consumption monitoring
- Supports sustainable energy management and reporting
- Enables reliable sub-metering for billing and cost allocation
- Enhances network reliability with continuous power quality monitoring



A meter should be selected according to the network (single-phase or three-phase) and its maximum current, required displayed values and communication type allowing it to be run by a supervision system.

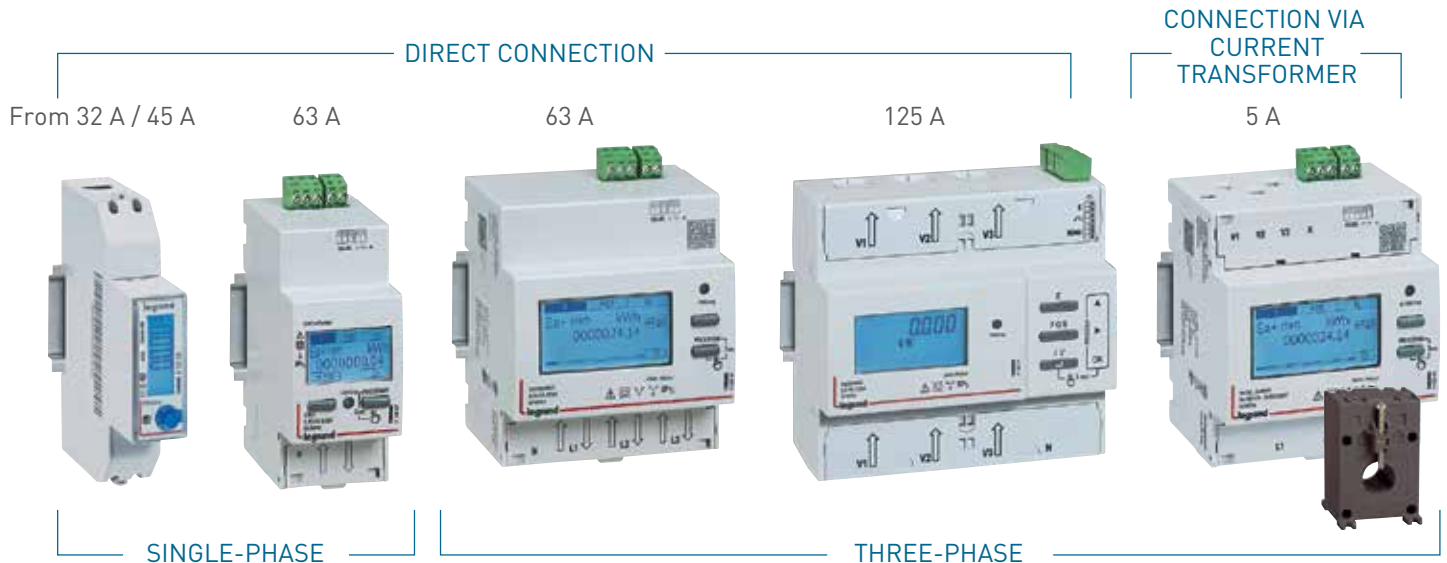

Conforming to standards IEC 61557-12, IEC 62053-21/23, IEC 62052-11, IEC 62052-31, EN 50470-1/3 (for the MID version)

Scan to know more about the product.



**EMDX<sup>3</sup>**  
**Multi-Function Meters for Smart Distribution Board**

**Din Rail Mounting**

Din Rail Meters for Smart Distribution Board.  
 LCD meter with bright graphical back lit display.  
 1P / 3P Direct connection or connection with CT. Measures kWh as well as other values like current, voltage, active energy, power etc.

Confirms to Standards: IEC 61557-12; IEC 62053-21/23; IEC 62052-11 and IEC 62052-31

MID\* compliance ensures accuracy for billing

**Dual Tariff meters**

WAGES Enabled (1 Pulse input to connect water meter, gas meter etc.)

\*MID - Measuring Instruments Directive. The meters comply to MID, ensures the highest levels of reliability and transparency, and in order to provide complete metrological assurance, applications that necessitate the installation of meters dedicated to invoicing purposes.

**Direct Connection**

**Single Phase**

Cat. Nos	Current Rating (A)	Description	No. of Modules	MRP* ₹ / Unit	Pack
0046 70	32	32A 1P Energy Meter with Pulse Output	1	■	1
4120 68	45	45A 1P Multi Function Meter with RS-485	1	■	1
4120 69	45	45A 1P Multi Function Meter with Pulse Output - MID	1	■	1
4120 80	63	63A 1P Multi Function Meter with WAGES & Pulse Output	2	■	1
4120 82	63	63A 1P Multi Function Meter with WAGES & Pulse Output - MID	2	■	1
4120 81	63	63A 1P Multi Function Meter with Dual Tariff / WAGES & RS-485	2	■	1
4120 83	63	63A 1P Multi Function Meter with Dual Tariff / WAGES & RS-485 - MID	2	■	1



4120 80

\* MRP - Maximum Retail Price Inclusive of all taxes including GST.  
 ■ Price available on request.

**EMDX<sup>3</sup>**  
**Multi-Function Meters for Smart Distribution Board**

Cat. Nos	Current Rating (A)	Description	No. of Modules	MRP* ₹ / Unit	Pack
----------	--------------------	-------------	----------------	---------------	------

**Direct Connection**

**Three Phase**

4120 90	63	63A 3P Multi Function Meter with WAGES & Pulse Output	4	■	1
4120 92	63	63A 3P Multi Function Meter with WAGES & Pulse Output - MID	4	■	1
4120 91	63	63A 3P Multi Function Meter with Dual Tariff / WAGES & RS-485	4	■	1
4120 93	63	63A 3P Multi Function Meter with Dual Tariff / WAGES & RS-485 - MID	4	■	1
4120 74	125	125A 3P Multi Function Meter with Dual Tariff / WAGES, RS-485 & Pulse Output	6	■	1
4120 75	125	125A 3P Multi Function Meter with Dual Tariff / WAGES, RS-485 & Pulse Output - MID	6	■	1



4120 91

**Connection with CT**

4120 40	5	3P with CT Multi Function Meter with WAGES & Pulse Output	4	■	1
4120 42	5	3P with CT Multi Function Meter with WAGES & Pulse Output - MID	4	■	1
4120 41	5	3P with CT Multi Function Meter with Dual Tariff / WAGES & RS-485	4	■	1
4120 43	5	3P with CT Multi Function Meter with Dual Tariff / WAGES & RS-485 - MID	4	■	1

Bold Cat.Nos are products normally available with Legrand (India) Stockists. Cat.Nos that are not bold - delivery within 4 - 8 weeks from the date of order. Bold packing quantity is our mandatory packing. Orders to be placed by Legrand (India) Stockist in multiples of the same.

### EMDX<sup>3</sup> Digital Panel Meter

Cat. Nos	Description	MRP* ₹ / Unit	Pack
----------	-------------	------------------	------

#### Modular Multi Function Meter

LCD meter with bright graphical back lit display.  
 4 Dedicated Keys (V / I / P Q S / E P F F)  
 Precision class 1 / 0.5  
 Connection with current transformers (CT)  
 Measurement of currents, voltages, frequency, active, reactive and apparent power, power factor, active and reactive energy  
 4 tariff metering  
 THD voltages, currents and harmonic analysis up to order 25th (available on Modbus COM port)  
 Programmable alarms on all functions  
 RS 485 and pulse output  
 Phase sequence correction diagnostic  
 Customized display page

Cat. Nos	Current Rating (A)	Description	No. of Modules	MRP* ₹ / Unit	Pack
4120 45	5	Modular Multi Function Meter with THD - RS-485 & Pulse Output CI 1	4	■	1
4120 51	5	4 Tariff Modular Multi Function Meter with Individual THD, Programmable alarms - RS-485 & Pulse Output CI 0.5	4	■	1



4120 51

#### Pulse Concentrator

For collecting and transmitting measurements taken by 12 universal pulse electricity meters. Collects pulses from other meters (gas meters, water meters, etc.) RS-485 output

Cat. Nos	Description	No. of Modules	MRP* ₹ / Unit	Pack
4120 65	Pulse Concentrator	4	■	1



4120 65

\* MRP - Maximum Retail Price Inclusive of all taxes including GST.  
 ■ Price available on request.

### EMDX<sup>3</sup> Digital Panel Meter

Cat. Nos	Description	MRP* ₹ / Unit	Pack
----------	-------------	------------------	------

#### Communication Interface

For mounting on door or solid faceplate  
 Dimensions: 96 x 96 x 62 mm  
 LCD meter with bright graphical back lit display.  
 4 Dedicated Keys (V / I / P Q S / E P F F)  
 Measurement of currents, voltages, active, reactive and apparent power and power factor

#### Metering:

- Active energy consumed or produced
- Reactive energy consumed or produced
- Operating time
- Pulses
- THD voltages, currents, and individual harmonic up to order 25(1)
- RS 485 communication and Pulse output
- Phase sequence correction diagnostic
- Optorelays with potential-free SPST-NO contact
- Customized display page

Cat. Nos	Description	MRP* ₹ / Unit	Pack
----------	-------------	------------------	------

4120 47	Multi Function Meter with THD - RS-485 & Pulse Output CI 1	■	1
4120 52	Advance Multi Function Meter with Individual THD - RS-485 & Pulse Output CI 0.5	■	1



4120 52

#### Power Quality & Network Analyzer with Data Logger

**Dimensions:** 96 x 96 x 62 mm  
 LCD meter with bright graphical back lit display.  
 Customized display page  
 4 Dedicated Keys (V / I / P Q S / E P F F)  
 Precision class: 0.5  
 Measurement of currents, voltages, active, reactive

Bold Cat.Nos are products normally available with Legrand (India) Stockists. Cat.Nos that are not bold - delivery within 4 - 8 weeks from the date of order. Bold packing quantity is our mandatory packing. Orders to be placed by Legrand (India) Stockist in multiples of the same.

**EMDX<sup>3</sup>**  
**Power Quality & Network Analyzer with Data Logger**

Cat. Nos	Description	MRP* ₹ / Unit	Pack
----------	-------------	------------------	------

and apparent power, internal temperature and power factor

Metering:

- active energy consumed or produced
- Reactive energy consumed or produced
- Operating time
- THD
- Programmable alarms on all functions
- Power quality functions: harmonics (U & I) to 50th, dips, swells, interruption, rapid voltage change and flickers
- Memory embedded (8 Mb)
- RTC (real time clock)
- Can take 4 EMDX3 optional modules

Cat. Nos	Description	MRP* ₹ / Unit	Pack
----------	-------------	------------------	------

4120 53	Power Quality & Network Analyzer with Data Logger	■	1
4120 55	R485 communication module with Modbus link	■	1
4120 59	2 Pulse output module for energy count	■	1
4120 57	2 inputs / 2 outputs module	■	1
4120 60	2 analog outputs module	■	1
4120 58	Temperature module	■	1

\* MRP - Maximum Retail Price Inclusive of all taxes including GST.  
 ■ Price available on request.



0046 89

**EMDX<sup>3</sup>**  
**Energy Management Multi-Support Web Servers**

Cat. Nos	Description	MRP* ₹ / Unit	Pack
----------	-------------	------------------	------

**RS485 / Ethernet**

0046 89	IP converter For RS 485/Ethernet conversion for connecting electricity meters and measurement control units to an IP network	■	1
---------	---	---	---

**Energy Management Multi-Support Web Servers**

Allow remote configuration, test, control and visualization, via a web browser on PCs, smartphones, web viewers, tablet computers, of data

**Features**

- In-built IP converter
- Power supply: 9 to 28 V= with the help of a single-phase switching mode power supply Cat.No 1 467 21 to be ordered separately
- With the Legrand Power supervision system, circuit breakers are integrated in a supervision system
- You can therefore check the status of the circuit breakers, measure the electrical values and control the circuit breakers remotely
- MODBUS protocol

Cat. Nos	Description	MRP* ₹ / Unit	Pack
----------	-------------	------------------	------

4149 47	For 10 Modbus addresses or 10 pulse modules	■	1
4149 48	For 32 Modbus addresses or 32 pulse modules	■	1
4149 49	For 255 Modbus addresses or 255 pulse modules Supplied with external power supply and fixing" brackets	■	1



4149 48

Bold Cat.Nos are products normally available with Legrand (India) Stockists. Cat.Nos that are not bold - delivery within 4 - 8 weeks from the date of order. Bold packing quantity is our mandatory packing. Orders to be placed by Legrand (India) Stockist in multiples of the same.

# PMX

## DIGITAL PANEL METERS

### Precise Monitoring for Smarter Energy Management



The PMX series of digital panel meters provides a comprehensive metering solution for low-voltage installations, ranging from basic volt and amp meters to advanced multifunction meters and power quality analyzers. These meters help monitor, analyse, and optimise electrical loads across panels, generators, and industrial equipment.

#### Features

- Wide range from basic meters to advanced multifunction models
- True RMS measurements with high accuracy
- Universal power supply with flexible CT/PT configurations
- Communication-ready with Modbus and pulse outputs

#### Benefits

- Improves visibility of electrical parameters for better load management
- Enables accurate energy monitoring and cost allocation
- Enhances reliability through power quality and demand tracking
- Simplifies panel design by replacing multiple analog meters with a compact digital solution



Scan to know more about the product.



## PMX Digital Panel Meters

Cat.Nos	Model Series	Description	MRP* ₹ / Unit	Pack
---------	--------------	-------------	------------------	------

### PMX 1000 Precise Single Function Meters

#### Features

- **RoHS Compliance**
- True RMS measurement
- High accuracy with class 1 as per IEC 62053-21
- Volts & Amps:  $\pm 1.0\%$  of Rated Current.
- **Bright 7 Segment LED display with four digit resolution and 14mm Height**
- Auto and Manual scrolling
- **Site selectable CT/PT ratios**
- Site selectable CT Secondary 1 A/5 A
- **Site selectable 3Phase 4Wire, 3Phase 3Wire & 1Ph configuration**
- Suitable for 50/60 Hz
- Wide range of control power supply 80 - 300 V AC, 40-70 Hz
- Low burden  $< 0.2$  VA per phase Volts & Amps
- Average & Phase wise measurements
- Password protection



4149 77



4149 78

4149 75	PMX 1100	1Ph Ammeter CI 1	1652	1
4149 76	PMX 1200	1Ph Voltmeter CI 1	1652	1
4149 77	PMX 1103	3 Ph Ammeter CI 1	2392	1
4149 78	PMX 1203	3Ph Voltmeter CI 1 + Hz	2392	1

### PMX 4000 True VAF + PF Meter

#### Features

- **RoHS Compliance**
- **Displays Current, line to neutral & line to line Voltages, frequency & Power Factor. (VA & PF - Phase Wise & Average)**
- **Display on Hours**
- True RMS measurement with simulations sampling of Current & Voltage
- High accuracy with class 1 as per IEC 62053-21 Volts & Amps:  $\pm 1.0\%$  of Rated Current.
- **3 Row Display with LED status for different parameter selection.**
- Auto and Manual scrolling
- Site selectable CT/PT ratios
- Site selectable CT Secondary 1 A/5 A
- Site selectable 3Phase 4Wire, 3Phase 3Wire & 1Ph configuration
- Suitable for 50/60 Hz
- Universal control power supply 80 - 300 V AC/DC, 40-70 Hz
- Low burden  $< 0.2$  VA per phase Volts & Amps
- Average & Phase wise measurements
- **Password protection**
- **Seamless integration with EMS/SCADA system with RS485 serial channel communication,**



4149 82

## PMX Digital Panel Meters

Cat.Nos	Model Series	Description	MRP* ₹ / Unit	Pack
---------	--------------	-------------	------------------	------

### Industry standard Modbus RTU protocol.

4149 79	PMX 4000	3 Ph VAF + PF meter CI 1	4050	1
4149 80	PMX 4000	3 Ph VAF + PF meter CI 1 with RS485	4830	1



4149 80

### PMX 5000 Smart Energy Meters For Smart Energy Billing

#### Features

- **RoHS Compliance**
- kWh/kVA
- **Old Energy register for back up of last cleared energy values**
- Bright LED with parameter name and value
- Auto scaling capability in adjustment of Kilo, Mega, Giga.
- kWh / kVA / PF / W - any one programmable
- **Positive energy accumulation even with CT polarity reversal with reverse lock program**
- High Accuracy with class 1 as per IEC 62053-21
- Site selectable CT/PT ratios
- Site selectable CT Secondary 1 A/5 A
- Universal control power supply 80 - 300 V AC/DC, 40-70 Hz
- Password protection for tamper proofing
- **Seamless integration with EMS/SCADA system with RS485 serial channel communication, Industry standard Modbus RTU protocol.**
- **Pulse output for integration into a process through PLC/DCS for online energy management**
- Provision for Tamper proofing with meter casing\* \*optional strip for tamper proofing.

4149 81	PMX 5000	kWh LED meter CI 1	4642	1
4149 82	PMX 5000	kWh LED meter CI 1 with RS485	5332	1
4149 83	PMX 5000	kWh LED meter CI 1 with Pulse Output	6480	1

### PMX 6000 Multi Dual Source Meter

#### Features

- **RoHS Compliance**
- **Bright LED display for showing parameters for both EB & DG**
- **Displays full range of parameters**  
Basic : VLL, VLN, A (Avg. & Phase wise), F  
Power: W, PF (Avg. & Phase wise)  
Energy: Wh
- **Load Hours, Run Hours, Old Wh, Old Load Hours for both EB & DG.**
- **DG Sensing input - 230 VAC**
- Auto scaling capability in adjustment of Kilo, Mega, Giga.
- Positive energy accumulation even with CT polarity reversal with reverse lock program.
- High Accuracy with class 1 as per IEC 62053-21 & class 0.5 as per IEC 62053-22

Bold Cat.Nos are products normally available with Legrand (India) Stockists. Cat.Nos that are not bold - delivery within 4 - 8 weeks from the date of order. Bold packing quantity is our mandatory packing. Orders to be placed by Legrand (India) Stockist in multiples of the same.

\* MRP - Maximum Retail Price Inclusive of all taxes including GST.

## PMX Digital Panel Meters

Cat.Nos	Model Series	Description	MRP* ₹ / Unit	Pack
---------	--------------	-------------	------------------	------

- Site selectable CT/PT ratios
- Site selectable CT Secondary 1 A/5 A
- Universal control power supply 80 – 300 V AC/DC, 40-70 Hz
- Password protection for tamper proofing
- **Seamless integration with EMS/SCADA system with RS485 serial channel communication, Industry standard Modbus RTU protocol.**
- Provision for Tamper proofing with meter casing\*  
\*optional strip for tamper proofing



4149 85

4149 84	PMX 6000	Dual Source LED meter CI 1 with RS485	8280	1
4149 85	PMX 6000	Dual Source LED meter CI 0.5 with RS485	9860	1

### PMX 7000 Multifunction Meter

Features

- **RoHS Compliance**
- **Bright LED display to view more than 25 parameters.**
- Displays full range of parameters  
Basic : VLL, VLN, A (Avg. & Phase Wise), F  
Power: W, PF, VA (Avg. & Phase Wise)  
Energy: Wh,
- **Load Hours, Run Hours, Old Wh, Old Load Hours**
- Auto scaling capability in adjustment of Kilo, Mega, Giga.
- **Positive energy accumulation even with CT polarity reversal with reverse lock programmable**
- High Accuracy with class 1 as per IEC 62053-21
- Site selectable CT/PT ratios
- Site selectable CT Secondary 1 A/5 A
- Universal control power supply 80 – 300 V AC/DC, 40-70 Hz
- Password protection for tamper proofing
- **Seamless integration with EMS/SCADA system with RS485 serial channel communication, Industry standard Modbus RTU protocol**
- Provision for Tamper proofing with meter casing\*  
\*optional strip for tamper proofing



4149 90



4149 91

4149 90	PMX 7000	MFM (VAF + W/VA/PF/Wh) LED meter CI 1 with RS485 <sup>^</sup>	8230	1
4149 91	PMX 7300	MFM LED meter CI 1	9950	1
4149 92	PMX 7300	MFM LED meter CI 1 with RS485	11880	1

\* MRP - Maximum Retail Price Inclusive of all taxes including GST.

## PMX Digital Panel Meters

Cat.Nos	Model Series	Description	MRP* ₹ / Unit	Pack
---------	--------------	-------------	------------------	------

### PMX 7400

#### Advance Multifunction Meter / Load Manager / Demand Monitor

Features

- **RoHS Compliance**
- **Advance multifunction meter with High/Low recording of VLL, VLN, A, Hz, PF, Var with time stamp.**
- **Voltage & Current THD (Total Harmonics Distortion) with Individual harmonics up to 31st order.**
- **K-factor V & A to keep check on the losses due to harmonic load currents & their effects on transformer heating.**
- Load manager with demand monitoring
- **RTC based Demand management**
- **Import/Export/Net monitoring of Wh, VAh, VARh Inductive/Capacitive, Load hours**
- Auto scaling capability in adjustment of Kilo, Mega, Giga.
- **Positive energy accumulation even with CT polarity reversal with reverse lock programmable**
- High Accuracy with class 1 as per IEC 62053-21 & class 0.5s as per IEC 62053-22
- Site selectable CT/PT ratios
- Site selectable CT Secondary 1 A/5 A
- Universal control power supply 80-300 V AC/DC, 40-70 Hz
- Password protection for tamper proofing
- **Seamless integration with EMS/SCADA system with RS485 serial channel communication, Industry standard Modbus RTU protocol.**
- Byte order option – Field Programmable Float/ Little Endian/ Big Endian data formats



4149 96

4149 93	PMX 7400	MFM + THD LED meter CI 1 with RS485	15900	1
4149 94	PMX 7400	MFM + THD LED meter CI 0.5 with RS485	19500	1
4149 95	PMX 7410	MFM + THD + Demand monitoring LED meter CI 1 with RS485	23090	1
4149 96	PMX 7420	MFM + THD with Individual + Harmonics + Demand + Import/Export LED meter CI 1 with RS485	23930	1

Bold Cat.Nos are products normally available with Legrand (India) Stockists. Cat.Nos that are not bold - delivery within 4 - 8 weeks from the date of order. Bold packing quantity is our mandatory packing. Orders to be placed by Legrand (India) Stockist in multiples of the same.

## PMX Digital Panel Meters

Cat.Nos	Model Series	Description	MRP* ₹ / Unit	Pack
4149 97	PMX 7420	MFM + THD with Individual + Harmonics + Demand + Import/Export LED meter CI 0.5s with RS485	27680	1

### PMX 8000 Advance Demand Controller

#### Features

- RoHS Compliance
- Demand controller with 4 relay output
- High memory Data Logger (8MB) for storing multiple parameters.
- Predictive demand with date & time stamping
- Voltage & Current THD (Total Harmonics Distortion) with Individual harmonics up to 31st order.
- K-factor V & A to keep check on the losses due to harmonic load currents & their effects on transformer heating.
- Advance multifunction meter with High/Low recording of VLL, VLN, A, Hz, PF, Var with time stamp.
- RTC based Demand management
- Import/Export/Net monitoring of Wh, VAH, VARh Inductive/Capacitive, Load hours
- Auto scaling capability in adjustment of Kilo, Mega, Giga.
- Positive energy accumulation even with CT polarity reversal with reverse lock programmable
- High Accuracy with class 1 as per IEC 62053-21
- Site selectable CT/PT ratios
- Site selectable CT Secondary 1 A/5 A
- Universal control power supply 80 - 300 V AC/DC, 40-70 Hz
- Password protection for tamper proofing
- Seamless integration with EMS/SCADA system with RS485 serial channel communication, Industry standard Modbus RTU protocol.
- Byte order option - Field Programmable Float/ Little Endian/ Big Endian data formats



4149 98

4149 98	PMX 8000	Demand Controller CI 1 with data logger + Bi directional + THD with Individual Harmonics	53650	1
---------	-------------	--	-------	---

\* MRP - Maximum Retail Price Inclusive of all taxes including GST.

# CTX<sup>3</sup> MINI Contactors

Ultra-Compact Contactor  
for Motor, Lighting & Heating  
Control (Up to 16 A)



CTX<sup>3</sup> MINI contactors are compact switching devices designed for reliable control of motors, lighting, and heating circuits up to 16 A. With a space-saving design, flexible mounting options, and integrated auxiliary contacts, they provide an efficient solution for modern distribution boards and control panels where space and reliability are essential.

### Features

- Ultra-compact 3-pole design up to 16 A
- DIN-rail or plate mounting options
- IP2X protected screw terminals
- Integrated auxiliary contact for control signalling

### Benefits

- Enables space-efficient installation in electrical panels
- Simplifies and speeds up installation and retrofits
- Enhances safety with touch-proof terminal protection
- Ensures reliable switching for motor, lighting, and heating applications



Scan to know more about  
the product.

# CTX<sup>3</sup> RTX<sup>3</sup> MPX<sup>3</sup>

Motor Control Range

## Uncompromising Performance for Motor Protection and Control



The CTX<sup>3</sup> contactors, RTX<sup>3</sup> thermal relays and MPX<sup>3</sup> motor protection circuit breakers form a complete and coordinated range for reliable motor protection and control. Designed for commercial and industrial applications, the range combines compact dimensions with robust performance.

### Features

- CTX<sup>3</sup> contactors and RTX<sup>3</sup> thermal relays up to 800 A
- MPX<sup>3</sup> motor protection circuit breakers up to 100 A
- High endurance with reliable overload and short-circuit protection
- Compact design with flexible mounting and accessories

### Benefits

- Enables simpler motor control architecture with an integrated solution
- Optimises panel layout with reduced wiring complexity
- Enhances system reliability with robust motor protection
- Supports flexible installations across diverse motor applications



Scan to know more about the product.



## Mini Contactors CTX<sup>3</sup> 6 to 16 A Industrial Contactors

Cat.Nos	Max. opt. current AC 3	Max. opt. current AC 1	Control voltage	MRP* ₹ / Unit	Pack
---------	------------------------	------------------------	-----------------	---------------	------

An Ultra Compact Solution Upto 16A (AC3 ) 3P & 4P

For Switching Motors, Lighting and Heating Circuits  
Ultra High Reliability  
Ultra High Endurance  
Ultra Low Wattloss

### Features

Conforms to IEC/EN 60947-4-1  
CE & UL Certified  
Range From 6A to 16A AC3  
Available in 3P & 4P  
Click fit accessories  
Ultra Compact design  
Front and side add on auxiliary contact  
Mechanical Interlock unit  
mini Thermal Overload Relay

### Spare Coils available

RoHS Compliant

### 3 Pole Mini Contactors

With integrated auxiliary contact  
Power terminals: screw terminals

#### 6 A - Integrated auxiliary contact 1 NO

4170 00	6 A	20 A	24 V~	1810	1
4170 01	6 A	20 A	24 V=	2470	1
4170 04	6 A	20 A	110 V~	1810	1
4170 06	6 A	20 A	230 V~	1810	1
4170 09	6 A	20 A	415 V~	1810	1

#### 6 A - Integrated auxiliary contact 1 NC

4170 10	6 A	20 A	24 V~	1810	1
4170 11	6 A	20 A	24 V=	2470	1
4170 14	6 A	20 A	110 V~	1810	1
4170 16	6 A	20 A	230 V~	1810	1
4170 19	6 A	20 A	415 V~	1810	1

#### 9 A - Integrated auxiliary contact 1 NO

4170 20	9 A	20 A	24 V~	1980	1
4170 21	9 A	20 A	24 V=	2630	1
4170 24	9 A	20 A	110 V~	1980	1
4170 26	9 A	20 A	230 V~	1980	1
4170 29	9 A	20 A	415 V~	1980	1

#### 9 A - Integrated auxiliary contact 1 NC

4170 30	9 A	20 A	24 V~	1980	1
4170 31	9 A	20 A	24 V=	2630	1
4170 34	9 A	20 A	110 V~	1980	1
4170 36	9 A	20 A	230 V~	1980	1
4170 39	9 A	20 A	415 V~	1980	1

#### 12 A - Integrated auxiliary contact 1 NO

4170 40	12 A	20 A	24 V~	2150	1
4170 41	12 A	20 A	24 V=	3210	1
4170 44	12 A	20 A	110 V~	2150	1
4170 46	12 A	20 A	230 V~	2150	1
4170 49	12 A	20 A	415 V~	2150	1

#### 12 A - Integrated auxiliary contact 1 NC

4170 50	12 A	20 A	24 V~	2150	1
4170 51	12 A	20 A	24 V=	3210	1
4170 54	12 A	20 A	110 V~	2150	1
4170 56	12 A	20 A	230 V~	2150	1
4170 59	12 A	20 A	415 V~	2150	1

\* MRP - Maximum Retail Price Inclusive of all taxes including GST.  
■ Price available on request.

## Mini Contactors CTX<sup>3</sup> 6 to 16 A Industrial Contactors

Cat.Nos	Max. opt. current AC 3	Max. opt. current AC 1	Control voltage	MRP* ₹ / Unit	Pack
---------	------------------------	------------------------	-----------------	---------------	------

#### 16 A - Integrated auxiliary contact 1 NO

4170 60	16 A	20 A	24 V~	2580	1
4170 61	16 A	20 A	24 V=	3720	1
4170 64	16 A	20 A	110 V~	2580	1
4170 66	16 A	20 A	230 V~	2580	1
4170 69	16 A	20 A	415 V~	2580	1

#### 16 A - Integrated auxiliary contact 1 NC

4170 70	16 A	20 A	24 V~	2580	1
4170 71	16 A	20 A	24 V=	3720	1
4170 74	16 A	20 A	110 V~	2580	1
4170 76	16 A	20 A	230 V~	2580	1
4170 79	16 A	20 A	415 V~	2580	1

### 4-Pole Mini Contactors

Without integrated auxiliary contact  
Power terminals: screw terminals

Cat.Nos	Max. opt. current AC 1	Max. opt. current AC 3	Control voltage	MRP* ₹ / Unit	Pack
---------	------------------------	------------------------	-----------------	---------------	------

#### 20 A

4171 40	20 A	16 A	24 V~	2340	1
4171 41	20 A	16 A	24 V=	2960	1
4171 44	20 A	16 A	110 V~	2340	1
4171 46	20 A	16 A	230 V~	2340	1
4171 49	20 A	16 A	415 V~	2340	1

## Mini Thermal Overload Relays RTX<sup>3</sup> mini

### For Mini Contactors

Cat.Nos	Setting Range	MRP* ₹ / Unit	Pack
---------	---------------	---------------	------

### Features

Conforms to IEC/EN 60947-4-1  
CE & UL Certified  
Thermal protection of circuits against overload, long starting times, and phase failure  
Trip Class 10A  
Trip Indication  
Manual/Automatic Reset  
**Integrated auxiliary contacts 1 NO & 1 NC**

### Thermal Overload Relays For 3 Pole Mini Contactors

#### Class 10 A - Integrated auxiliary contacts 1 NO + 1 NC

4170 80	0.1~0.16 A	2090	1
4170 81	0.16~0.25 A	2090	1
4170 82	0.25~0.4 A	2090	1
4170 83	0.4~0.63 A	2090	1
4170 84	0.63~1 A	2090	1
4170 85	1~1.6 A	2090	1
4170 86	1.6~2.5 A	2090	1
4170 87	2.5~4 A	2090	1
4170 88	4~6 A	2090	1
4170 89	5~8 A	2090	1
4170 90	6~9 A	2090	1
4170 91	7~10 A	2090	1
4170 92	9~13 A	2090	1
4170 93	12~16 A	2090	1



4170 88

**Bold Cat.Nos** are products normally available with Legrand (India) Stockists.  
Cat.Nos that are not bold - delivery within 4 - 8 weeks from the date of order.  
Bold packing quantity is our mandatory packing. Orders to be placed by Legrand (India) Stockist in multiples of the same.

## Mini Thermal Overload Relays

### RTX<sup>3</sup> mini

#### Accessories for Mini Contactors CTX<sup>3</sup>

Cat.Nos	Setting Range	MRP* ₹ / Unit	Pack
---------	---------------	------------------	------

#### Add on Auxiliary Blocks for Mini Contactors

High Thermal current - 10 A  
lth: 10 A

#### Front Mounting

4171 50	1 NO + 1 NC	610	10
4171 51	2 NO	610	10
4171 52	2 NC	610	10
4171 53	4 NO	940	10
4171 54	3 NO + 1 NC	940	10
4171 55	2 NO + 2 NC	940	10
4171 56	1 NO + 3 NC	940	10
4171 57	4 NC	940	10

#### Side Mounting

4171 58	1 NO	610	10
4171 59	1 NC	610	10

#### Interlock Unit

4171 60	Mechanical interlock for mini contactors	980	5
---------	--	-----	---

#### Spare Coils

4171 70	24 V~	1090	5
4171 71	24 V=	1480	5
4171 74	110 V~	1090	5
4171 76	230 V~	1090	5
4171 79	415 V~	1090	5

## Power Contactors CTX<sup>3</sup>

### Uncompromising Performance For Motor

### Protection & Control

Range from 9A to 800A (AC3) Contactors

#### Features

Conforms to IEC/EN 60947-4-1

CE & UL Certified

Extra Mechanical life upto 15 Million

Extra Electrical life upto 2.5 Million

Extra Low Consumption

Compact size

integrated auxiliary contacts

**Front safety Cover to prevent dust entry**

Direct Clipping on Din Rail

**Both Sides Terminal connection**

Click fit accessories

Interlocking kits

Spare Coils

RoHS Complaint

### 3 Pole Contactors CTX<sup>3</sup>

#### 9 A To 100 A Industrial Contactors

Cat.Nos	Max. opt. current AC 3	Max. opt. current AC 1	Control voltage	MRP* ₹ / Unit	Pack
---------	------------------------	------------------------	-----------------	------------------	------

#### CTX<sup>3</sup> 22

With integrated auxiliary contacts

Power terminals: screw terminals

**9 A - Integrated auxiliary contacts 1 NO + 1 NC**

4160 80	9 A	25 A	24 V~	1940	1
4160 81	9 A	25 A	24 V=	3190	1
4160 82	9 A	25 A	48 V~	1940	1
4160 83	9 A	25 A	48 V=	3190	1
4160 84	9 A	25 A	110 V~	1940	1
4160 86	9 A	25 A	230 V~	1940	1
4160 88	9 A	25 A	380 V~	1940	1
4160 89	9 A	25 A	415 V~	1940	1

\* MRP - Maximum Retail Price Inclusive of all taxes including GST.

## 3 Pole Contactors CTX<sup>3</sup>

### 9 A to 100 A Industrial Contactors

Cat.Nos	Max. opt. current AC 3	Max. opt. current AC 1	Control voltage	MRP* ₹ / Unit	Pack
---------	------------------------	------------------------	-----------------	------------------	------

**12 A - Integrated auxiliary contacts 1 NO + 1 NC**

4160 90	12 A	25 A	24 V~	2190	1
4160 91	12 A	25 A	24 V=	3450	1
4160 92	12 A	25 A	48 V~	2190	1
4160 93	12 A	25 A	48 V=	3450	1
4160 94	12 A	25 A	110 V~	2190	1
4160 96	12 A	25 A	230 V~	2190	1
4160 98	12 A	25 A	380 V~	2190	1
4160 99	12 A	25 A	415 V~	2190	1

**18 A - Integrated auxiliary contacts 1 NO + 1 NC**

4161 00	18 A	40 A	24 V~	2580	1
4161 01	18 A	40 A	24 V=	4200	1
4161 02	18 A	40 A	48 V~	2580	1
4161 03	18 A	40 A	48 V=	4200	1
4161 04	18 A	40 A	110 V~	2580	1
4161 06	18 A	40 A	230 V~	2580	1
4161 08	18 A	40 A	380 V~	2580	1
4161 09	18 A	40 A	415 V~	2580	1

**22 A - Integrated auxiliary contacts 1 NO + 1 NC**

4161 10	22 A	40 A	24 V~	3190	1
4161 11	22 A	40 A	24 V=	5400	1
4161 12	22 A	40 A	48 V~	3190	1
4161 13	22 A	40 A	48 V=	5400	1
4161 14	22 A	40 A	110 V~	3190	1
4161 16	22 A	40 A	230 V~	3190	1
4161 18	22 A	40 A	380 V~	3190	1
4161 19	22 A	40 A	415 V~	3190	1

#### CTX<sup>3</sup> 40

With integrated auxiliary contacts

Power terminals: screw terminals

**32 A - Integrated auxiliary contacts 2 NO + 2 NC**

4161 20	32 A	50 A	24 V~	6670	1
4161 21	32 A	50 A	24 V=	11540	1
4161 22	32 A	50 A	48 V~	6670	1
4161 23	32 A	50 A	48 V=	11540	1
4161 24	32 A	50 A	110 V~	6670	1
4161 26	32 A	50 A	230 V~	6670	1
4161 28	32 A	50 A	380 V~	6670	1
4161 29	32 A	50 A	415 V~	6670	1

**40 A - Integrated auxiliary contacts 2 NO + 2 NC**

4161 30	40 A	60 A	24 V~	9880	1
4161 31	40 A	60 A	24 V=	14460	1
4161 32	40 A	60 A	48 V~	9880	1
4161 33	40 A	60 A	48 V=	14460	1
4161 34	40 A	60 A	110 V~	9880	1
4161 36	40 A	60 A	230 V~	9880	1
4161 38	40 A	60 A	380 V~	9880	1
4161 39	40 A	60 A	415 V~	9880	1

#### CTX<sup>3</sup> 65

With integrated auxiliary contacts

**50 A - Integrated auxiliary contacts 2 NO + 2 NC**

Screw terminals

4161 40	50 A	70 A	24 V~	12080	1
4161 41	50 A	70 A	24 V=	16640	1
4161 42	50 A	70 A	48 V~	12080	1
4161 43	50 A	70 A	48 V=	16640	1
4161 44	50 A	70 A	110 V~	12080	1
4161 46	50 A	70 A	230 V~	12080	1
4161 48	50 A	70 A	380 V~	12080	1
4161 49	50 A	70 A	415 V~	12080	1

**Bold Cat.Nos** are products normally available with Legrand (India) Stockists. Cat.Nos that are not bold - delivery within 4 - 8 weeks from the date of order. Bold packing quantity is our mandatory packing. Orders to be placed by Legrand (India) Stockist in multiples of the same.



4171 55



4160 96



4161 26



4161 46

### 3 pole contactors CTX<sup>3</sup> 9 A To 100 A Industrial Contactors

Cat.Nos	Max. opt. current AC 3	Max. opt. current AC 1	Control voltage	MRP* ₹ / Unit	Pack
---------	------------------------	------------------------	-----------------	---------------	------

**65 A** - Integrated auxiliary contacts 2 NO + 2 NC  
Screw terminals

4161 60	65 A	100 A	24 V~	16060	1
4161 61	65 A	100 A	24 V=	18700	1
4161 62	65 A	100 A	48 V~	16060	1
4161 63	65 A	100 A	48 V=	18700	1
4161 64	65 A	100 A	110 V~	16060	1
4161 66	65 A	100 A	230 V~	16060	1
4161 68	65 A	100 A	380 V~	16060	1
4161 69	65 A	100 A	415 V~	16060	1

#### CTX<sup>3</sup> 100

With integrated auxiliary contacts

**75 A** - Integrated auxiliary contacts 2 NO + 2 NC  
Screw terminals

4161 80	75 A	110 A	24 V~	19940	1
4161 81	75 A	110 A	24 V=	22370	1
4161 82	75 A	110 A	48 V~	19940	1
4161 83	75 A	110 A	48 V=	22370	1
4161 84	75 A	110 A	110 V~	19940	1
4161 86	75 A	110 A	230 V~	19940	1
4161 88	75 A	110 A	380 V~	19940	1
4161 89	75 A	110 A	415 V~	19940	1

**85 A** - Integrated auxiliary contacts 2 NO + 2 NC  
Screw terminals

4162 00	85 A	135 A	24 V~	20640	1
4162 01	85 A	135 A	24 V=	23660	1
4162 02	85 A	135 A	48 V~	20640	1
4162 03	85 A	135 A	48 V=	23660	1
4162 04	85 A	135 A	110 V~	20640	1
4162 06	85 A	135 A	230 V~	20640	1
4162 08	85 A	135 A	380 V~	20640	1
4162 09	85 A	135 A	415 V~	20640	1

**100 A** - Integrated auxiliary contacts 2 NO + 2 NC  
Screw terminals

4162 20	100 A	160 A	24 V~	25720	1
4162 21	100 A	160 A	24 V=	28920	1
4162 22	100 A	160 A	48 V~	25720	1
4162 23	100 A	160 A	48 V=	28920	1
4162 24	100 A	160 A	110 V~	25720	1
4162 26	100 A	160 A	230 V~	25720	1
4162 28	100 A	160 A	380 V~	25720	1
4162 29	100 A	160 A	415 V~	25720	1

### 3 Pole Contactors CTX<sup>3</sup> 130 A To 800 A Industrial Contactors

#### CTX 150

With integrated auxiliary contacts

**130 A** - Integrated auxiliary contacts 2 NO + 2 NC  
Screw terminals

4162 40	130 A	160 A	24 V~	38240	1
4162 41	130 A	160 A	24 V=	42020	1
4162 42	130 A	160 A	48 V~	38240	1
4162 43	130 A	160 A	48 V=	42020	1
4162 46	130 A	160 A	100-240 V~/=	38240	1
4162 49	130 A	160 A	400-440 V~	38240	1

**150 A** - Integrated auxiliary contacts 2 NO + 2 NC  
Screw terminals

4162 60	150 A	210 A	24 V~	38760	1
4162 61	150 A	210 A	24 V=	41470	1
4162 62	150 A	210 A	48 V~	38760	1
4162 63	150 A	210 A	48 V=	41470	1

\* MRP - Maximum Retail Price Inclusive of all taxes including GST.

### 3 Pole Contactors CTX<sup>3</sup> 130 A To 800 A Industrial Contactors

Cat.Nos	Max. opt. current AC 3	Max. opt. current AC 1	Control voltage	MRP* ₹ / Unit	Pack
---------	------------------------	------------------------	-----------------	---------------	------

**150 A** - Integrated auxiliary contacts 2 NO + 2 NC  
Screw terminals

4162 66	150 A	210 A	100-240 V~/=	38760	1
4162 69	150 A	210 A	400-440 ~A	38760	1

#### CTX<sup>3</sup> 225

With integrated auxiliary contacts - Screw terminals

**185 A** - Integrated auxiliary contacts 2 NO + 2 NC

4162 80	185 A	230 A	24 V~/=	48930	1
4162 82	185 A	230 A	48 V~/=	48930	1
4162 86	185 A	230 A	100-240 V~/=	44120	1
4162 89	185 A	230 A	380-450 V~	44120	1

**225 A** - Integrated auxiliary contacts 2 NO + 2 NC

4162 90	225 A	275 A	24 V~/=	50500	1
4162 92	225 A	275 A	48 V~/=	50500	1
4162 96	225 A	275 A	100-240 V~/=	44650	1
4162 99	225 A	275 A	380-450 V~	44650	1

#### CTX<sup>3</sup> 400

With integrated auxiliary contacts - Screw terminals

**265 A** - Integrated auxiliary contacts 2 NO + 2 NC

4163 06	265 A	300 A	100-240 V~/=	58550	1
4163 09	265 A	300 A	380-450 V~	58550	1

**330 A** - Integrated auxiliary contacts 2 NO + 2 NC

4163 16	330 A	350 A	100-240 V~/=	68290	1
4163 19	330 A	350 A	380-450 V~	68290	1

**400 A** - Integrated auxiliary contacts 2 NO + 2 NC

4163 26	400 A	450 A	100-240 V~/=	83530	1
4163 29	400 A	450 A	380-450 V~	83530	1

#### CTX<sup>3</sup> 800

With integrated auxiliary contacts - Screw terminals

**500 A** - Integrated auxiliary contacts 2 NO + 2 NC

4163 36	500 A	580 A	200-240 V~/=	125520	1
4163 39	500 A	580 A	380-450 V~	125520	1

**630 A** - Integrated auxiliary contacts 2 NO + 2 NC

4163 46	630 A	660 A	200-240 V~/=	178730	1
4163 49	630 A	660 A	380-450 V~	178730	1

**800 A** - Integrated auxiliary contacts 2 NO + 2 NC

4163 56	800A	900 A	200-240 V~/=	266540	1
4163 59	800 A	900 A	380-450 V~	266540	1

Bold Cat.Nos are products normally available with Legrand (India) Stockists. Cat.Nos that are not bold - delivery within 4 - 8 weeks from the date of order. Bold packing quantity is our mandatory packing. Orders to be placed by Legrand (India) Stockist in multiples of the same.



4161 86



4162 96



4162 46



4163 56

## Thermal Relays RTX<sup>3</sup> For CTX<sup>3</sup> 3 Pole Industrial Contactors

Cat.Nos	I min. (A)	I max. (A)	MRP* ₹ / Unit	Pack
---------	---------------	---------------	---------------------	------

### Features

Conforms to IEC/EN 60947-4-1

CE & UL Certified

Thermal protection of circuits against overload, long starting times, and phase failure

Trip Class 10A

Trip Indication

Manual/Automatic Reset

### Integrated Auxiliary Contacts 1 NO & 1 NC

Standard type:

- Overload detecting bimetal is used all for three phases

Differential type:

- Standard type characteristics + phase failure protection

### Thermal Overload Relays

Class 10A - Integrated auxiliary contacts 1 NO + 1 NC

### RTX<sup>3</sup> 40 - for CTX<sup>3</sup> 22 and 40

Standard type with screw terminals

Cat.Nos	I min. (A)	I max. (A)	MRP* ₹ / Unit	Pack
4166 40	0.1	0.16	2600	1
4166 41	0.16	0.25	2600	1
4166 42	0.25	0.4	2600	1
4166 43	0.4	0.63	2600	1
4166 44	0.63	1	2600	1
4166 45	1	1.6	2600	1
4166 46	1.6	2.5	2600	1
4166 47	2.5	4	2600	1
4166 48	4	6	2600	1
4166 49	5	8	2600	1

### RTX<sup>3</sup> 40 - for CTX<sup>3</sup> 22 and 40

Standard type with screw terminals

Cat.Nos	I min. (A)	I max. (A)	MRP* ₹ / Unit	Pack
4166 50	6	9	2600	1
4166 51	7	10	2600	1
4166 52	9	13	2600	1
4166 53	12	18	2600	1
4166 54	16	22	2710	1
4166 55	18	25	2750	1
4166 56	22	32	3120	1
4166 57	28	40	3360	1



4167 31



4167 65

## Thermal Relays RTX<sup>3</sup> For CTX<sup>3</sup> 3 Pole Industrial Contactors

Cat.Nos	I min. (A)	I max. (A)	MRP* ₹ / Unit	Pack
---------	---------------	---------------	---------------------	------

### RTX<sup>3</sup> 40 - for CTX<sup>3</sup> 22 and 40

Differential type with screw terminals

Cat.Nos	I min. (A)	I max. (A)	MRP* ₹ / Unit	Pack
4166 60	0.1	0.16	3170	1
4166 61	0.16	0.25	3170	1
4166 62	0.25	0.4	3170	1
4166 63	0.4	0.63	3210	1
4166 64	0.63	1	3210	1
4166 65	1	1.6	3210	1
4166 66	1.6	2.5	3210	1
4166 67	2.5	4	3210	1
4166 68	4	6	3220	1
4166 69	5	8	3220	1
4166 70	6	9	3220	1
4166 71	7	10	3220	1
4166 72	9	13	3220	1
4166 73	12	18	3370	1
4166 74	16	22	3370	1
4166 75	18	25	3370	1
4166 76	22	32	4110	1
4166 77	28	40	4110	1

### RTX<sup>3</sup> 65 - for CTX<sup>3</sup> 65

Standard type with screw terminals

Cat.Nos	I min. (A)	I max. (A)	MRP* ₹ / Unit	Pack
4166 83	9	13	5230	1
4166 84	12	18	5230	1
4166 85	16	22	5230	1
4166 86	18	25	5230	1
4166 87	24	36	5230	1
4166 88	28	40	5230	1
4166 89	34	50	5230	1
4166 90	45	65	5230	1

### RTX<sup>3</sup> 100 - for CTX<sup>3</sup> 100

Standard type with screw terminals

Cat.Nos	I min. (A)	I max. (A)	MRP* ₹ / Unit	Pack
4167 23	18	25	8460	1
4167 24	24	36	8460	1
4167 25	28	40	8460	1
4167 26	34	50	8460	1
4167 27	45	65	8460	1
4167 28	54	75	8460	1
4167 29	63	85	8460	1
4167 30	70	95	8460	1
4167 31	80	100	8460	1

### RTX<sup>3</sup> 150 - for CTX<sup>3</sup> 150

Standard type with screw terminals

Cat.Nos	I min. (A)	I max. (A)	MRP* ₹ / Unit	Pack
4167 60	45	65	12450	1
4167 61	54	75	12450	1
4167 62	63	85	12450	1
4167 63	80	105	12450	1
4167 64	95	130	12450	1
4167 65	110	150	12450	1

\* MRP - Maximum Retail Price Inclusive of all taxes including GST.

**Bold Cat.Nos** are products normally available with Legrand (India) Stockists. Cat.Nos that are not bold - delivery within 4 - 8 weeks from the date of order. Bold packing quantity is our mandatory packing. Orders to be placed by Legrand (India) Stockist in multiples of the same.

## Thermal Relays RTX<sup>3</sup> For CTX<sup>3</sup> 3 Pole Industrial Contactors

Cat.Nos	Description	MRP* ₹ / Unit	Pack
---------	-------------	------------------	------

### Separate Mounting Units

To mount the relays separately from contactors, on DIN rail or panel by fixing screws

4165 91	For RTX <sup>3</sup> 40 up to 32 A	970	1
4165 92	For RTX <sup>3</sup> 40 40 A	970	1
4165 93	For RTX <sup>3</sup> 65 with screw terminals	1200	1
4165 94	For RTX <sup>3</sup> 65 with cage terminals	1200	1
4165 95	For RTX <sup>3</sup> 100 with screw terminals	1520	1
4165 96	For RTX <sup>3</sup> 100 with cage terminals	1520	1
4165 97	For RTX <sup>3</sup> 150 with screw terminals	2410	1
4165 98	For RTX <sup>3</sup> 150 with cage terminals	2410	1

### Thermal Overload Relays

Class 10 A - Integrated auxiliary contacts 1 NO + 1 NC

Cat.Nos	I min. (A)	I max. (A)	MRP* ₹ / Unit	Pack
---------	------------	------------	------------------	------

### RTX<sup>3</sup> 225 - for CTX<sup>3</sup> 225

Differential type with screw terminals

4167 80	65	100	16920	1
4167 81	85	125	16920	1
4167 82	100	160	18760	1
4167 83	120	185	18760	1
4167 84	160	240	19480	1



4167 84

### RTX<sup>3</sup> 400 - for CTX<sup>3</sup> 400

Differential type with screw terminals

4167 86	85	125	24840	1
4167 87	100	160	24840	1
4167 88	120	185	24840	1
4167 89	160	240	24840	1
4167 90	200	330	24840	1
4167 91	260	400	24840	1

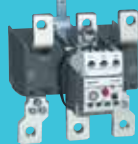

4167 91

### RTX<sup>3</sup> 800 - for CTX<sup>3</sup> 800

Differential type with screw terminals

4167 92	200	300	38630	1
4167 93	260	400	38630	1
4167 94	400	630	38630	1
4167 95	520	800	38630	1



4164 36

## 4-pole contactors CTX<sup>3</sup> 40 A to 900 A Industrial Contactors and Spare Coils

Cat.Nos	Max. opt. current AC 1	Max. opt. current AC 3	Control voltage	MRP* ₹ / Unit	Pack
---------	------------------------	------------------------	-----------------	------------------	------

### Contactors CTX<sup>3</sup>

Power terminals: screw terminals

Without integrated auxiliary contact

4164 26	40 A	22 A	230 V~	4190	1
4164 36	60 A	40 A	230 V~	10420	1
4164 46	100 A	65 A	230 V~	17890	1
4164 56	135 A	85 A	230 V~	22010	1



4164 56

\* MRP - Maximum Retail Price Inclusive of all taxes including GST.

## 4-Pole Contactors CTX<sup>3</sup> 40 A to 900 A Industrial Contactors and Spare Coils

Cat.Nos	Max. opt. current AC 1	Max. opt. current AC 3	Control voltage	MRP* ₹ / Unit	Pack
---------	------------------------	------------------------	-----------------	------------------	------

### With Integrated Auxiliary Contacts

Auxiliary contacts: 2 NO + 2 NC

4164 66	165 A	130 A	100-240 V~/=	36470	1
4164 76	250 A	150 A	100-240 V~/=	49010	1
4164 86	330 A	225 A	100-240 V~/=	54530	1
4164 96	420 A	330 A	100-240 V~/=	100830	1
4165 06	500 A	400 A	100-240 V~/=	110330	1
4165 16	750 A	630 A	200-240 V~/=	221780	1
4165 26	900 A	800 A	200-240 V~/=	268130	1



4164 86

### Spare Coils for CTX<sup>3</sup> 4P Contactors

Cat.Nos	Description	MRP* ₹ / Unit	Pack
---------	-------------	------------------	------

### Control voltage 230 V~

4165 46	For CTX <sup>3</sup> 40 A to 60 A (AC-1)	2050	1
4165 56	For CTX <sup>3</sup> 100 A to 135 A (AC-1)	2440	1
4165 66	For CTX <sup>3</sup> 165 A to 330 A (AC-1)	12810	1
4165 76	For CTX <sup>3</sup> 420 A to 500 A (AC-1)	23930	1
4165 86	For CTX <sup>3</sup> 750 A to 900 A (AC-1)	35900	1

### CTX<sup>3</sup> Add-On Auxiliary Contact Blocks

#### Front Mounting

For CTX<sup>3</sup> 3P form 9 A to 150 A (AC-3) and CTX<sup>3</sup> 4P from 40 A to 135 A (AC-1) - 2 and 4 pole - lth: 16 A

4168 50	1 NO + 1 NC	650	10
4168 51	2 NO	650	10
4168 52	2 NC	650	10
4168 53	4 NO	1030	10
4168 54	3 NO + 1 NC	1030	10
4168 55	2 NO + 2 NC	1030	10
4168 56	1 NO + 3 NC	1030	10
4168 57	4 NC	1030	10



4168 50



4168 55

#### Side Mounting

2 pole - Mounting on both sides

4168 58	For CTX <sup>3</sup> 3P Form 9 A to 150 A (AC-3) 1 NO + 1 NC - lth: 16 A	1120	10
4168 59	For CTX <sup>3</sup> 3P Form 185 A to 800 A (AC-3) and CTX <sup>3</sup> 4P from 165 A to 900 A (AC-1) 1 NO + 1 NC - lth: 16 A	1120	10
4168 49	For CTX <sup>3</sup> 4P From 40 A to 135 A (AC-1) 1 NO + 1 NC - lth: 16 A	1120	10

Bold Cat.Nos are products normally available with Legrand (India) Stockists. Cat.Nos that are not bold - delivery within 4 - 8 weeks from the date of order. Bold packing quantity is our mandatory packing. Orders to be placed by Legrand (India) Stockist in multiples of the same.

## 4-Pole Contactors CTX<sup>3</sup>

### 40 A to 900 A Industrial Contactors and Spare Coils



Cat.Nos	Description	MRP* ₹ / Unit	Pack
---------	-------------	------------------	------

#### CTX<sup>3</sup> Time Delay Blocks

For CTX<sup>3</sup> 3P from 9 A to 150 A (AC-3)

Time delay: 1 to 30 s

Front mounting

#### On Delay

4168 70	24-48 V~/=	3000	1
4168 71	110-230 V~	3000	1

#### Off Delay

4168 72	24-48 V~/=	4110	1
4168 73	110-230 V~	3920	1

## CTX<sup>3</sup>

**capacitor Switching Units Cat.Nos 4168 74/75/76/77**  
Capacitor Unit Is Connected To The Terminals Of The Contactor To Reduce The High Inrush Current.

IEC 60947-4-1 AC 6b

Type	Contactor		Maximum operating power (kVAr)			Max. Peak current (A)
			220 - 240 V	400 - 480 V	500 - 550 V	
4168 74	CTX <sup>3</sup> 22	9 A	5	9.7	14	560
	CTX <sup>3</sup> 22	12 A	6.7	12.5	18	560
	CTX <sup>3</sup> 22	18 A	8.5	16.7	24	850
	CTX <sup>3</sup> 22	22 A	10	18	26	1250
	CTX <sup>3</sup> 40	32 A	15	25	36	1900
	CTX <sup>3</sup> 40	40 A	20	33.3	48	2160
4168 75/76	CTX <sup>3</sup> 65	50 A	20	40	58	2160
	CTX <sup>3</sup> 65	65 A	25	45.7	66	3040
4168 77	CTX <sup>3</sup> 100	75 A	29.7	54	78	3040
	CTX <sup>3</sup> 100	85 A	35	60	92	3040
	CTX <sup>3</sup> 100	100 A	37	62	94	3040
Without Capacitor Switching Unit as per IEC 60947-4-1 AC 6b	CTX <sup>3</sup> 150	150 A		70		3300
	CTX <sup>3</sup> 225	185 A		84	120	3500
	CTX <sup>3</sup> 225	225 A		115	130	4000
	CTX <sup>3</sup> 400	265 A		125	140	5000
	CTX <sup>3</sup> 400	330 A		139	185	6500
	CTX <sup>3</sup> 400	400 A		185	195	8000
	CTX <sup>3</sup> 800	500 A		220	330	10000
	CTX <sup>3</sup> 800	630 A		291	340	12000
	CTX <sup>3</sup> 800	800 A		369	370	14200

#### Note:

- When the switch is closed capacitor must be discharged before recharged. (Maximum residual voltage at terminals ≤ 50 V)
- To prevent short current, gG type fuse must be 1.5 - 2 times than rated current

\* MRP - Maximum Retail Price Inclusive of all taxes including GST.

## CTX<sup>3</sup> Accessories

Cat.Nos	Description	MRP* ₹ / Unit	Pack
---------	-------------	------------------	------

#### CTX<sup>3</sup> Capacitor Switching Units

AC-6b

Operating power from 9.7 kVAr to 62 kVAr (400/440 V)

4168 74	For contactors CTX <sup>3</sup> 3P from 9 to 40 A, upto 33.3 kVAr at 440 V / 48 kVAr at 525 V	2840	1
4168 75	For contactors CTX <sup>3</sup> 3P 50 and 65 A with screw terminals upto 45.7 kVAr at 440 V / 66 kVAr at 525 V	3870	1
4168 76	For contactors CTX <sup>3</sup> 3P 50 and 65 A with cage terminals upto 45.7 kVAr at 440 V / 66 kVAr at 525 V	4190	1
4168 77	For contactors CTX <sup>3</sup> 3P 75 to 100 A with screw terminals upto 62 kVAr at 440 V / 94 kVAr at 525 V	4190	1

#### CTX<sup>3</sup> Interlocking

Component parts for assembling by customer  
Horizontal mounting

#### Interlock Units

4168 79	Mechanical interlocks for CTX <sup>3</sup> 4P from 40 to 135 A (AC-1)	1700	5
---------	---	------	---

#### Interlock Units

4168 80	Mechanical interlocks for CTX <sup>3</sup> 3P from 9 to 150 A Provides 2 NC contacts for use in electrical interlocking	3450	1
4168 87	Mechanical interlocks for CTX <sup>3</sup> 3P from 185 to 400 A and CTX <sup>3</sup> 4P from 165 to 500 A	5980	1

#### Interlock Units

4168 88	Mechanical interlocks for CTX <sup>3</sup> 3P from 500 to 800 A	8000	1
4168 89	Mechanical interlocks for CTX <sup>3</sup> 4P from 750 to 900 A	8460	1

#### Wire Kits

Used for making reversing between two 3P contactors

4168 82	For CTX <sup>3</sup> 22	1750	5
4168 83	For CTX <sup>3</sup> 40	2360	5
4168 84	For CTX <sup>3</sup> 65	2900	5
4168 85	For CTX <sup>3</sup> 100	4860	5

**Bold Cat.Nos** are products normally available with Legrand (India) Stockists. Cat.Nos that are not bold - delivery within 4 - 8 weeks from the date of order. **Bold packing quantity** is our mandatory packing. Orders to be placed by Legrand (India) Stockist in multiples of the same.

## CTX<sup>3</sup> Accessories



4168 91



4168 97



4168 40

Cat.Nos	Description	MRP* ₹ / Unit	Pack
---------	-------------	------------------	------

### Boxes for Motor Starter

For CTX<sup>3</sup> 22 equipped with RTX<sup>3</sup> 40 (0.1 - 22 A)

4168 90	Without pushbuttons	4440	1
4168 91	With pushbuttons	5440	1

### CTX<sup>3</sup> Transient Voltage Suppressor Blocks

Absorbs the surge arisen out of the coil of the contactor

4168 95	24-48 V~/=	860	10
4168 96	100-125 V~/=	860	10
4168 97	200-240 V~/=	860	10
4168 98	380-400 V~	860	10

### CTX<sup>3</sup> Terminals Covers

4168 42	For CTX <sup>3</sup> 3P from 185 to 225 A (AC-3)	780	5
4168 43	For CTX <sup>3</sup> 3P from 265 to 400 A (AC-3)	1160	5
4168 44	For CTX <sup>3</sup> 3P from 500 to 900 A (AC-3)	1760	5
4168 45	For CTX <sup>3</sup> 4P from 165 to 330 A (AC-1)	970	5
4168 46	For CTX <sup>3</sup> 4P from 420 to 500 A (AC-1)	1480	5
4168 47	For CTX <sup>3</sup> 4P from 750 to 900 A (AC-1)	2500	5

### CTX<sup>3</sup> Safety Front Cover

4168 40	For CTX <sup>3</sup> 3P from 9 to 150 A (AC-3) and CTX <sup>3</sup> 4P from 40 to 135 A (AC-1)	50	50
4168 41	For CTX <sup>3</sup> 3P from 85 to 800 A (AC-3) and CTX 4P from 165 to 900 A (AC-1)	200	50

### Distant Reset Flexible Cables for Thermal Relays

4168 92	400 mm	1460	1
4168 93	500 mm	1590	1
4168 94	600 mm	1620	1

## CTX<sup>3</sup> spare coils

### Spare Coils for CTX<sup>3</sup> 3P Contactors

For CTX<sup>3</sup> 22

4169 00	24 V~	1100	5
4169 02	48 V~	1100	5
4169 04	110 V~	1100	5
4169 06	230 V~	1100	5
4169 08	380 V~	1100	5
4169 09	415 V~	1100	5

\* MRP - Maximum Retail Price Inclusive of all taxes including GST.  
 ■ Price available on request.

## CTX<sup>3</sup> Accessories

Cat.Nos	Description	MRP* ₹ / Unit	Pack
---------	-------------	------------------	------

### For CTX<sup>3</sup> 40

4169 20	24 V~	1100	5
4169 21	24 V=	1100	5
4169 22	48 V~	1100	5
4169 23	48 V=	1100	5
4169 24	110 V~	1100	5
4169 26	230 V~	1100	5
4169 28	380 V~	1100	5
4169 29	415 V~	1100	5

### For CTX<sup>3</sup> 65

4169 30	24 V~	1690	5
4169 31	24 V=	1690	5
4169 32	48 V~	1690	5
4169 33	48 V=	1690	5
4169 34	110 V~	1690	5
4169 36	230 V~	1690	5
4169 38	380 V~	1690	5
4169 39	415 V~	1690	5

### For CTX<sup>3</sup> 100

4169 40	24 V~	2070	3
4169 41	24 V=	2070	3
4169 42	48 V~	2070	3
4169 43	48 V=	2070	3
4169 44	110 V~	2070	3
4169 46	230 V~	2070	3
4169 48	380 V~	2070	3
4169 49	415 V~	2070	3

### For CTX<sup>3</sup> 150

4169 50	24 V~	7820	1
4169 51	24 V=	7820	1
4169 52	48 V~	7820	1
4169 53	48 V=	7820	1
4169 56	100-240 V~/=	7820	1
4169 59	400-440 V~	7820	1

Bold Cat.Nos are products normally available with Legrand (India) Stockists. Cat.Nos that are not bold - delivery within 4 - 8 weeks from the date of order. Bold packing quantity is our mandatory packing. Orders to be placed by Legrand (India) Stockist in multiples of the same.

## Auxillary Contactor / Control Relays CTX<sup>3</sup>



4169 66

Cat.Nos	Description	MRP* ₹ / Unit	Pack
---------	-------------	------------------	------

### For CTX<sup>3</sup> 225

4169 60	24 V~/=	11320	1
4169 62	48 V~/=	11320	1
4169 66	100-240 V~/=	11320	1
4169 69	400-440 V~	11320	1

### For CTX<sup>3</sup> 400

4169 76	100-240 V~/=	17020	1
4169 79	380-450 V~	17020	1

### For CTX<sup>3</sup> 800

4169 86	200-240 V~/=	37050	1
4169 89	380-450 V~	37050	1

## Auxillary Contactor / Control Relays CTX<sup>3</sup>

4 pole

Conform to IEC 60 947-1, IEC 60 947-4-1 and IEC 60 947-5-1 for the auxiliary contacts

**CE & UL Certified**

**Ultra High Ith = 10 A**

Ultra Low consumption coil

Click fit accessories

**Spare Coils available**

RoHS Complaint

**CTX<sup>3</sup> Control Relays**

**4 NO**

4168 00	24 V~	2220	1
4168 01	24 V=	3370	1
4168 02	48 V~	2220	1
4168 03	48 V=	3370	1
4168 04	110 V~	2220	1
4168 06	230 V~	2220	1
4168 09	415 V~	2220	1

### 3 NO + 1 NC

4168 10	24 V~	2220	1
4168 11	24 V=	3370	1
4168 12	48 V~	2220	1
4168 13	48 V=	3370	1
4168 14	110 V~	2220	1
4168 16	230 V~	2220	1
4168 19	415 V~	2220	1



4168 10

\* MRP - Maximum Retail Price Inclusive of all taxes including GST.

## Accessories for Auxiliary Contactor / Control Relays

Cat.Nos	Description	MRP* ₹ / Unit	Pack
---------	-------------	------------------	------

### 2 NO + 2 NC

4168 20	24 V~	2220	1
4168 21	24 V=	3400	1
4168 22	48 V~	2220	1
4168 23	48 V=	3370	1
4168 24	110 V~	2220	1
4168 26	230 V~	2220	1
4168 29	415 V~	2220	1

### High Thermal Current - 10 A

Ith : 10 A

#### Front Mounting

4171 50	1 NO + 1 NC	610	10
4171 51	2 NO	610	10
4171 52	2 NC	610	10
4171 53	4 NO	940	10
4171 54	3 NO + 1 NC	940	10
4171 55	2 NO + 2 NC	940	10
4171 56	1 NO + 3 NC	940	10
4171 57	4 NC	940	10

#### Side Mounting

4171 58	1 NO	610	10
4171 59	1 NC	610	10

#### Interlock Unit

4171 60	Mechanical Interlock	980	5
---------	----------------------	-----	---

#### Spare Coils

4171 70	24 V~	1090	5
4171 71	24 V=	1480	5
4171 74	110 V~	1090	5
4171 76	230 V~	1090	5
4171 79	415 V~	1090	5

**Bold Cat.Nos** are products normally available with Legrand (India) Stockists. Cat.Nos that are not bold - delivery within 4 - 8 weeks from the date of order. **Bold packing quantity** is our mandatory packing. Orders to be placed by Legrand (India) Stockist in multiples of the same.

# CX<sup>3</sup>

## EMS (Energy Management System)

### Smart Energy Management, Simplified



CX<sup>3</sup> EMS is a compact modular system for local or remote monitoring and control of electrical installations.

#### Features

- Energy measurement for single & three-phase networks
- Modbus RS-485 & Ethernet communication

#### Benefits

- Better energy visibility and cost control
- Improved operational reliability with real-time alerts



Scan to know more about the product.

### CX<sup>3</sup> Contactors

Cat.Nos	Description	MRP* ₹ / Unit	Pack
---------	-------------	------------------	------

#### Power Contactors CX<sup>3</sup>

Conform to IEC/EN 61095  
Space for power supply busbar on top (up to 25 A)

4125 44	25 A 2 NO contactor	3260	1
4125 45	40 A 2 NO contactor	5560	1
4125 47	63 A 2 NO contactor	6470	1
4125 48	63 A 2 NC contactor	6470	1
4125 49	40 A 3 NO contactor	9300	1
<b>4125 50</b>	63 A 3 NO contactor	10500	1
<b>4125 51</b>	25 A 4 NO contactor	3840	1
<b>4125 53</b>	40 A 4 NO contactor	9810	1
<b>4125 56</b>	63 A 4 NO contactor	11610	1
<b>4125 57</b>	63 A 4 NC contactor	11720	1

#### Signalling Auxiliaries For Contactors Auxiliary Changeover Switch

4124 29	For 1 module contactors 16 A to 25 A	4770	1
4124 30	For 2 module contactors 25 A	4790	1

\* MRP - Maximum Retail Price Inclusive of all taxes including GST.



4173 08

### MPCBs MPX<sup>3</sup>

Cat.Nos	Rated 3Ph Motor	Magnetic release operating current (A)	MRP* ₹ / Unit	Pack
---------	-----------------	--	------------------	------

#### Motor Protection Circuit Breakers From 0.16 A To 100 A Upto 45 KW

##### Maximum Efficiency In A Compact Unit

Conform to IEC 60947-1, IEC 60947-2, IEC 60947-4

Adjustable thermal release

##### Magnetic Release 13 le max

High breaking capacity

toggle handle

Fixing on rail or by screw

##### Wide Range Of Accessories

##### Undervoltage Release

##### Shunt Release

Auxiliary Contacts

##### IP 65 Enclosure

##### Thermal Magnetic MPCBs

Adjustable thermal release Magnetic release 13 le max.

##### MPX<sup>3</sup> 32S - 3P

Standard breaking capacity with toggle handle

Fixing on rail □

415 V breaking capacity Icu (kA) - 100

Cat.Nos	Rated 3Ph Motor (KW)	Thermal release adj. range (A)	Magnetic release operating current (A)	MRP* ₹ / Unit	Pack
4173 00	0.02	0.1 to 0.16	2.1	5120	1
4173 01	0.06	0.16 to 0.25	3.3	5120	1
4173 02	0.09	0.25 to 0.4	5.2	5120	1
4173 03	0.12	0.4 to 0.63	8.2	5960	1
4173 04	0.18 / 0.25	0.63 to 1	13	5960	1
4173 05	0.37 / 0.55	1 to 1.6	20.8	5990	1
4173 06	0.75	1.6 to 2.5	32.5	6110	1
4173 07	1.5	2.5 to 4	52	6210	1
4173 08	2.2	4 to 6	78	6240	1
4173 09	3	5 to 8	104	6240	1

415 V breaking capacity Icu (kA) - 50

4173 10	4	6 to 10	130	6240	1
4173 11	5.5	9 to 13	169	6300	1

415 V breaking capacity Icu (kA) - 20

4173 12	7.5	11 to 17	221	7410	1
---------	-----	----------	-----	------	---

415 V breaking capacity Icu (kA) - 15

4173 13	7.5	14 to 22	286	7870	1
4173 14	11	18 to 26	338	8460	1
4173 15	15	22 to 32	416	14050	1

**Bold Cat.Nos** are products normally available with Legrand (India) Stockists. Cat.Nos that are not bold - delivery within 4 - 8 weeks from the date of order. **Bold packing quantity** is our mandatory packing. Orders to be placed by Legrand (India) Stockist in multiples of the same.

## MPCBs MPX<sup>3</sup>

Cat.Nos	Description	MRP* ₹ / Unit	Pack
---------	-------------	---------------------	------

### MPX<sup>3</sup> 32H - 3P

High breaking capacity with rotary handle  
415 V breaking capacity Icu (kA) - 100

4173 20	0.02	0.1 to 0.16	2.1	6320	1
4173 21	0.06	0.16 to 0.25	3.3	6320	1
4173 22	0.09	0.25 to 0.4	5.2	6320	1
4173 23	0.12	0.4 to 0.63	8.2	6950	1
4173 24	0.18 / 0.25	0.63 to 1	13	6950	1
4173 25	0.37/ 0.55	1 to 1.6	20.8	6950	1
4173 26	0.75	1.6 to 2.5	32.5	6950	1
4173 27	1.5	2.5 to 4	52	7160	1
4173 28	2.2	4 to 6	78	7190	1
4173 29	3	5 to 8	104	7760	1
4173 30	4	6 to 10	130	7840	1
4173 31	5.5	9 to 13	169	8610	1

415 V breaking capacity Icu (kA) - 50

4173 32	7.5	11 to 17	221	9220	1
4173 33	7.5	14 to 22	286	10790	1
4173 34	11	18 to 26	338	10880	1
4173 35	15	22 to 32	416	16900	1

### MPX<sup>3</sup> 63H - 3P

High breaking capacity with rotary handle  
Fixing on rail or by screw  
415 V breaking capacity Icu (kA) - 100

4173 60	4	6 to 10	130	16400	1
4173 61	5.5	9 to 13	169	16400	1

415 V breaking capacity Icu (kA) - 50

4173 62	7.5	11 to 17	221	16400	1
4173 63	7.5	14 to 22	286	18590	1
4173 64	11	18 to 26	338	18590	1
4173 65	15	22 to 32	416	18590	1
4173 66	18.5	28 to 40	520	20770	1
4173 67	22	34 to 50	650	25510	1
4173 68	30	45 to 63	819	27220	1

### MPX<sup>3</sup> 100H - 3P

High breaking capacity with rotary handle  
Fixing on rail or by screw  
415 V breaking capacity Icu (kA) - 100

4173 70	7.5	11 to 17	221	22670	1
4173 71	7.5	14 to 22	286	22670	1
4173 72	11	18 to 26	338	26940	1



4173 68

## MPCBs MPX<sup>3</sup>

Cat.Nos	Description	MRP* ₹ / Unit	Pack
---------	-------------	---------------------	------

Used to connect MPX<sup>3</sup> directly with the contactor

4173 73	15	22 to 32	416	22670	1
4173 74	18.5	28 to 40	520	22670	1
4173 75	22	34 to 50	650	26940	1
4173 76	30	45 to 63	819	28250	1

415 V breaking capacity Icu (kA) - 75

4173 77	37	55 to 75	975	30360	1
4173 78	45	70 to 90	1170	30360	1
4173 79	45	80 to 100	1300	30360	1



4173 79

### Magnetic only MPCBs

Without thermal release  
Magnetic release 13 x Ie max.

### MPX<sup>3</sup> 32MA - 3P

High breaking capacity with rotary handle  
Fixing on rail   
415 V breaking capacity Icu (kA) - 100

4173 40	0.02	2.1	5790	1
4173 41	0.06	3.3	5790	1
4173 42	0.09	5.2	5790	1
4173 43	0.12	8.2	6450	1
4173 44	0.18 / 0.25	13	6450	1
4173 45	0.37 / 0.55	20.8	6450	1
4173 46	0.75	32.5	6450	1
4173 47	1.5	52	6540	1
4173 48	2.2	78	6540	1
4173 49	3	104	6540	1
4173 50	4	130	6890	1
4173 51	5.5	169	7330	1

415 V breaking capacity Icu (kA) - 50

4173 52	7.5	221	9430	1
4173 53	7.5	286	9430	1
4173 54	11	338	9430	1
4173 55	15	416	15590	1



4173 48

## MPCBs MPX<sup>3</sup> Accessories

Cat.Nos	Description	MRP* ₹ / Unit	Pack
---------	-------------	---------------------	------

### Auxiliary Contacts

2 pole

### Side Mounting

Mounting on the left side of MPCBs  
Two auxiliary contacts per MPCB

4174 00	1 NO + 1 NC	1240	5
4174 01	2 NO	1240	5
4174 02	2 NC	1240	5



4174 00

### Front mounting

One auxiliary contact per MPCB

4174 03	1 NO + 1 NC	1270	5
4174 04	2 NO	1270	5
4174 05	2 NC	1270	5

\* MRP - Maximum Retail Price Inclusive of all taxes including GST.

Bold Cat.Nos are products normally available with Legrand (India) Stockists.  
Cat.Nos that are not bold - delivery within 4 - 8 weeks from the date of order.  
Bold packing quantity is our mandatory packing. Orders to be placed by Legrand (India) Stockist in multiples of the same.

## MPCBs MPX<sup>3</sup> Accessories

Cat.Nos	Description	MRP* ₹ / Unit	Pack
---------	-------------	---------------------	------

### Alarm Contacts

1 NO + 1 NC

#### Any Trip Alarm Contact

Operates in case of trip

Mounting on the left side of MPCBs

Set alarm contact first in case of using auxiliary contact together (MPX<sup>3</sup> 63H can not accept auxiliary contact and alarm contact together)

4174 06	For MPX <sup>3</sup> 32	2010	1
4174 08	For MPX <sup>3</sup> 63 and 100	2010	1

#### Magnetic Trip Alarm Contact

Operates in case of instantaneous trip

Mounting on the left side of MPCBs

Set alarm contact first in case of using auxiliary contact together

4174 07	1 NO + 1 NC	2010	1
---------	-------------	------	---

### Shunt Release

Mounting On The Right Side Of MPCBs

One release per MPCB

4174 10	24 V~ 50 Hz / 28 V~ 60 Hz	3190	1
4174 11	110 V~ 50 Hz / 120 V~ 60 Hz	3190	1
4174 12	220-230 V~ 50 Hz / 240-260 V~ 60 Hz	3190	1
4174 13	380-400 V~ 50 Hz / 440-460 V~ 60 Hz	3190	1



4174 12

### Undervoltage Release

Mounting On The Right Side Of MPCBs

One release per MPCB

#### Without Auxiliary Contact

4174 20	24 V~ 50 Hz / 28 V~ 60 Hz	3190	1
4174 21	110 V~ 50 Hz / 120 V~ 60 Hz	3190	1
4174 22	220-230 V~ 50 Hz / 240-260 V~ 60 Hz	3190	1
4174 23	380-400 V~ 50 Hz / 440-460 V~ 60 Hz	3190	1



4174 22

\* MRP - Maximum Retail Price Inclusive of all taxes including GST.

## MPCBs MPX<sup>3</sup> Accessories

Cat.Nos	Description	MRP* ₹ / Unit	Pack
---------	-------------	---------------------	------

### With 2 NO Auxiliary Contacts

Can not attach to MPX<sup>3</sup> 32S

4174 30	24 V~ 50 Hz / 28 V~ 60 Hz	4250	1
4174 31	110 V~ 50 Hz / 120 V~ 60 Hz	4250	1
4174 32	220-230 V~ 50 Hz / 240-260 V~ 60 Hz	4250	1
4174 33	380-400 V~ 50 Hz / 440-460 V~ 60 Hz	4250	1

### Dial Cover

Sealable cover to protect the set value from the operation that is not intended

#### Without Auxiliary Contact

4174 79	For all types of MPX <sup>3</sup>	140	50
---------	-----------------------------------	-----	----

### Direct Adaptor and Mounting unit

For mounting CTX<sup>3</sup> contactors under MPX<sup>3</sup> MPCBs

#### Direct Adaptors

Used to connect MPX<sup>3</sup> directly with the contactor

4174 40	For MPX <sup>3</sup> 32S with CTX <sup>3</sup> mini AC	740	2
4174 41	For MPX <sup>3</sup> 32S with CTX <sup>3</sup> mini DC	740	2
4174 42	For MPX <sup>3</sup> 32H/32MA with CTX <sup>3</sup> mini AC	740	2
4174 43	For MPX <sup>3</sup> 32H/32MA with CTX <sup>3</sup> mini DC	740	2
4174 48	For MPX <sup>3</sup> 32S with CTX <sup>3</sup> 22 AC	890	2
4174 49	For MPX <sup>3</sup> 32S with CTX <sup>3</sup> 22 DC	890	2
4174 50	For MPX <sup>3</sup> 32H/32MA with CTX <sup>3</sup> 22 AC	890	2

**Bold Cat.Nos** are products normally available with Legrand (India) Stockists. Cat.Nos that are not bold - delivery within 4 - 8 weeks from the date of order. **Bold packing quantity** is our mandatory packing. Orders to be placed by Legrand (India) Stockist in multiples of the same.

## MPCBs MPX<sup>3</sup> Accessories

Cat.Nos	Description	MRP* ₹ / Unit	Pack
---------	-------------	---------------------	------

### Direct Adaptators

Used To Connect MPX<sup>3</sup> Directly with the Contactor

4174 51	For MPX <sup>3</sup> 32H/32MA with CTX <sup>3</sup> 22 DC	890	2
4174 52	For MPX <sup>3</sup> 32S with CTX <sup>3</sup> 40 AC	1090	2
4174 53	For MPX <sup>3</sup> 32S with CTX <sup>3</sup> 40 DC	1090	2
4174 54	For MPX <sup>3</sup> 32H/32MA with CTX <sup>3</sup> 40 AC	1090	2
4174 55	For MPX <sup>3</sup> 32H/32MA with CTX <sup>3</sup> 40 DC	1090	2
4174 56	For MPX <sup>3</sup> 63H with CTX <sup>3</sup> 65 AC with cage type terminals	1300	2
4174 57	For MPX <sup>3</sup> 63H with CTX <sup>3</sup> 65 DC with cage type terminals	1300	2
4174 58	For MPX <sup>3</sup> 100H with CTX <sup>3</sup> 100 AC with cage type terminals	1300	1
4174 59	For MPX <sup>3</sup> 100H with CTX <sup>3</sup> 100 DC with cage type terminals	1300	1

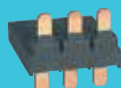

4174 56



4174 61

### Mounting Unit

This device is used for joining together MPX<sup>3</sup> MCPBs and CTX<sup>3</sup> contactors

4174 60	For MPX <sup>3</sup> 32S/32H/32MA	1010	2
4174 61	For MPX <sup>3</sup> 63H	1850	1
4174 62	For MPX <sup>3</sup> 100H	2230	1

## MPCBs MPX<sup>3</sup> Accessories

Cat.Nos	Description	MRP* ₹ / Unit	Pack
---------	-------------	---------------------	------

### Rotary Handle

Mounting On Panel's Door To Control The MPX<sup>3</sup>

4174 63	For MPX <sup>3</sup> 32H and 32 MA	2630	1
4174 64	For MPX <sup>3</sup> 63H	2630	1
4174 65	For MPX <sup>3</sup> 100H	3330	1



4174 63

### Phase Busbar

For Parallel Connection of MPX<sup>3</sup>

**For MPX<sup>3</sup> 32S, 32H and 32MA**

Rated Current 63 A

4174 71	2 devices	1040	5
4174 73	3 devices	2600	5
4174 75	4 devices	2600	5
4174 76	5 devices	2600	5
4174 77	Feeder for phase busbar 32 A	720	5



4174 73

### For MPX<sup>3</sup> 63H

Rated Current 108 A

4174 72	2 devices	1850	5
4174 74	3 devices	2780	5

### Enclosures for MPX<sup>3</sup> 32H and 32MA

IP 65 enclosure to use in dusty areas as well as in presence of corrosive gas or liquid

4174 80	Yellow/red with rotary handle	2150	5
4174 81	With black rotary handle	2780	5



4174 81

\* MRP - Maximum Retail Price Inclusive of all taxes including GST.

**Bold Cat.Nos** are products normally available with Legrand (India) Stockists. Cat.Nos that are not bold - delivery within 4 - 8 weeks from the date of order. Bold packing quantity is our mandatory packing. Orders to be placed by Legrand (India) Stockist in multiples of the same.

# Alpx<sup>3</sup>

## Capacitors

### Reliable and Efficient Power Factor Correction with Alpx<sup>3</sup>



Alpx<sup>3</sup> is a premium range of power capacitors designed for reliable reactive power compensation in modern electrical installations. With robust construction, compact design, and high-quality components, they ensure efficient performance and long service life even in networks with demanding harmonic conditions.

#### Features

- Self-healing capacitor technology
- Suitable for networks with harmonic distortion
- Compact design for easy panel integration
- Low-loss construction for improved efficiency

#### Benefits

- Reduces electricity costs by improving power factor
- Increases system capacity by freeing transformer and cable kVA
- Improves voltage stability for better equipment performance
- Enhances overall system efficiency and reliability



Scan to know more about  
the product.



## Alpx<sup>3</sup> Resin Filled Capacitors

Cat.Nos	Description	MRP* ₹ / Unit	Pack
---------	-------------	---------------------	------

Confirms to IS13340-1&2 , IEC60831-1&2  
ISI Mark  
Compact Design  
Self healing metallized polypropylene film  
Over pressure device for disconnection  
Low energy losses  
Resistance to high temperature  
Resin filled

Can be used in system with <= 10% THDi

### Standard Duty Can-Type 440 V

5150 00	1 kVAr Resin std duty 440 V	410	1
5150 01	2 kVAr Resin std duty 440 V	860	1
5150 02	3 kVAr Resin std duty 440 V	1230	1
5150 03	4 kVAr Resin std duty 440 V	1720	1
5150 04	5 kVAr Resin std duty 440 V	2010	1
5150 05	7.5 kVAr Resin std duty 440 V	2960	1
5150 06	10 kVAr Resin std duty 440 V	3950	1
5150 07	12.5 kVAr Resin std duty 440 V	4940	1
5150 08	15 kVAr Resin std duty 440 V	5920	1
5150 09	20 kVAr Resin std duty 440 V	7750	1
5150 10	25 kVAr Resin std duty 440 V	9780	1
5150 11	30 kVAr Resin std duty 440 V	11790	1



5150 04



5150 06

### Standard Duty Can-Type 480 V

5150 24	4.2 kVAr Resin 480 V	3030	1
5150 25	6.9 kVAr Resin 480 V	4880	1
5150 26	8.7 kVAr Resin 480 V	6180	1
5150 27	10.4 kVAr Resin 480 V	7430	1
5150 28	14 kVAr Resin 480 V	9900	1
5150 29	17.4 kVAr Resin 480 V	11720	1
5150 30	20.8 kVAr Resin 480 V	13930	1

## Alpx<sup>3</sup> Resin Filled Capacitors

Cat.Nos	Description	MRP* ₹ / Unit	Pack
---------	-------------	---------------------	------

### Standard Duty Can-Type 525 V

5150 31	5 kVAr Resin 525 V	3600	1
5150 32	8.3 kVAr Resin 525 V	6180	1
5150 33	10.4 kVAr Resin 525 V	7440	1
5150 34	12.5 kVAr Resin 525 V	9140	1
5150 35	16.7 kVAr Resin 525 V	11540	1
5150 36	20.8 kVAr Resin 525 V	14760	1
5150 37	25 kVAr Resin 525 V	17280	1

### Standard Duty Box-Type 440 V

5150 40	1 kVAr Std box Capacitor 440 V	550	1
5150 41	2 kVAr Std box Capacitor 440 V	1100	1
5150 42	3 kVAr Std box Capacitor 440 V	1660	1
5150 43	4 kVAr Std box Capacitor 440 V	2210	1
5150 44	5 kVAr Std box Capacitor 440 V	2720	1
5150 45	7.5 kVAr Std box Capacitor 440 V	4010	1
5150 46	8.33 kVAr Std box Capacitor 440 V	4520	1
5150 47	10 kVAr Std box Capacitor 440 V	5350	1
5150 48	12.5 kVAr Std box Capacitor 440 V	6690	1
5150 49	15 kVAr Std box Capacitor 440 V	8020	1
5150 50	20 kVAr Std box Capacitor 440 V	10500	1
5150 51	25 kVAr Std box Capacitor 440 V	13120	1
5150 52	50 kVAr Std box Capacitor 440 V	27250	1



5150 47

\* MRP - Maximum Retail Price Inclusive of all taxes including GST.

**Bold Cat.Nos** are products normally available with Legrand (India) Stockists. **Cat.Nos that are not bold** - delivery within 4 - 8 weeks from the date of order. **Bold packing quantity** is our mandatory packing. Orders to be placed by Legrand (India) Stockist in multiples of the same.

## Reactors

Cat.Nos	Description	MRP* ₹ / Unit	Pack
---------	-------------	------------------	------

Can be used in system with <= 15% THDi

### Heavy Duty Can-Type 440 V

5150 12	1 kVAr Resin heavy duty 440 V	780	1
5150 13	2 kVAr Resin heavy duty 440 V	1630	1
5150 14	3 kVAr Resin heavy duty 440 V	2340	1
5150 15	4 kVAr Resin heavy duty 440 V	3250	1
5150 16	5 kVAr Resin heavy duty 440 V	3510	1
5150 17	7.5 kVAr Resin heavy duty 440	5270	1
5150 18	10 kVAr Resin heavy duty 440	6890	1
5150 19	12.5 kVAr Resin heavy duty 44	8620	1
5150 20	15 kVAr Resin heavy duty 440	10350	1
5150 21	20 kVAr Resin heavy duty 440	13280	1
5150 22	25 kVAr Resin heavy duty 440	16600	1
5150 23	30 kVAr Resin heavy duty 440	20010	1



5150 23

## Reactors

Cat.Nos	Description	MRP* ₹ / Unit	Pack
---------	-------------	------------------	------

### Heavy Duty Box-Type 440 V

5150 53	5 kVAr HD box 440 V	4300	1
5150 54	7.5 kVAr HD box 440 V	6280	1
5150 55	8.33 kVAr HD box 440 V	6950	1
5150 56	10 kVAr HD box 440 V	8370	1
5150 57	12.5 kVAr HD box 440 V	10470	1
5150 58	15 kVAr HD box 440 V	12560	1
5150 59	20 kVAr HD box 440 V	15940	1
5150 60	25 kVAr HD box 440 V	19930	1
5150 61	50 kVAr HD box 440 V	39850	1



5150 61



4151 50

### Reactors 7 % Duty

4151 48	Reactor 10 kVAr	22350	1
4151 49	Reactor 12.5 kVAr	29270	1
4151 50	Reactor 25 kVAr	37260	1
4151 51	Reactor 50 kVAr	60610	1
4151 52	Reactor 100 kVAr	121400	1

### Reactors 14 % Duty

4151 53	Reactor 12.5 kVAr	39500	1
4151 54	Reactor 25 kVAr	65830	1
4151 55	Reactor 50 kVAr	87040	1

### Power Factor Controller Eco

4151 95	4 step controller	26310	1
4151 96	6 step controller	23860	1
4151 97	8 step controller	26760	1
4151 98	12 step controller	31820	1

\* MRP - Maximum Retail Price Inclusive of all taxes including GST.

## Warranty

- The Company, at its discretion, will replace products if they have any manufacturing defect within 1 years for capacitor, Reactor & APFC controller.
- The above guarantee is applicable when the products are selected taken into consideration all the technical characteristics of the product published in our catalogue.
- The guarantee is only applicable when the products are installed as per the Company's instructions and not tampered in any manner.
- The guarantee states the Company's entire liability. It does not extend to cover consequential loss or damage or installation costs arising from defective products.

## Alpx<sup>3</sup> range of capacitor - Selection Chart

### DETERMINING THE CAPACITOR BANK TYPE ACCORDING TO THE LEVEL OF HARMONICS

For supplies with a high level of harmonic pollution, Legrand recommends capacitor banks with detuned reactors.

The detuned reactor performs a threefold role:



- Increasing the capacitor impedance in relation to the harmonic currents
- Shifting the parallel resonance frequency (Fr.p) of the source and capacitor to below the main frequencies of the harmonic currents that are causing interference.

Tuning frequency (Hz)	Blocking factor (P%)	Tuning number (n)
189	7	3.78
135	14	2.7

- Helping to reduce harmonic levels in the supply.

The table opposite can be used to select the capacitor bank type according to the degree of harmonic pollution, by measuring the percentage of THDi and THDu or by estimating the percentage total power of SH/ST non-linear loads.

Measurements		Estimates	Type of capacitor to be used	Reactor to be used
THDU %	THDI %	SH/ST %		
≤ 3	≤ 10	≤ 15	Standard Duty	-
≤ 4	≤ 15	≤ 25	Heavy Duty	-
≤ 6	≤ 30	≤ 35	Standard Duty	7% Reactor *14% Reactor if high level of 3rd order harmonics
≤ 8	≤ 40	≤ 50	Heavy Duty	7% Reactor

SH (kVA) is the weighted total power of the harmonic generators present at the transformer secondary.

ST (kVA) is the power rating of the HV/LV transformer.

THDi = Total Harmonic Distortion (THD) is the ratio of the rms value of the harmonic currents In of the order n to the rms value of the fundamental.

THDu = Voltage Distortion (THDu) is caused mainly by the high level of Current Distortion (THDi) and the level of THDu is dependent on the source impedance.

\* for example if -

- Ih5 > 0.2x145
- Ih3 : 3rd order harmonic currents
- Ih5 : 5th order harmonic currents

Note: These statements are based on our knowledge of typical application. We clearly point out that these statements cannot be regarded as binding statements about the suitability of our products for a particular customer application. It is necessary that the customer should check and decide whether the product is suitable for use in a particular application.

# DX<sup>3</sup>

## Modular Protection Devices

### Complete Protection for Residential, Commercial & Industrial Applications



DX<sup>3</sup> protective devices deliver a comprehensive circuit protection solution built for modern electrical systems. Designed to support efficient panel building and consistent performance, they provide a dependable foundation for safe and streamlined electrical distribution across diverse applications.

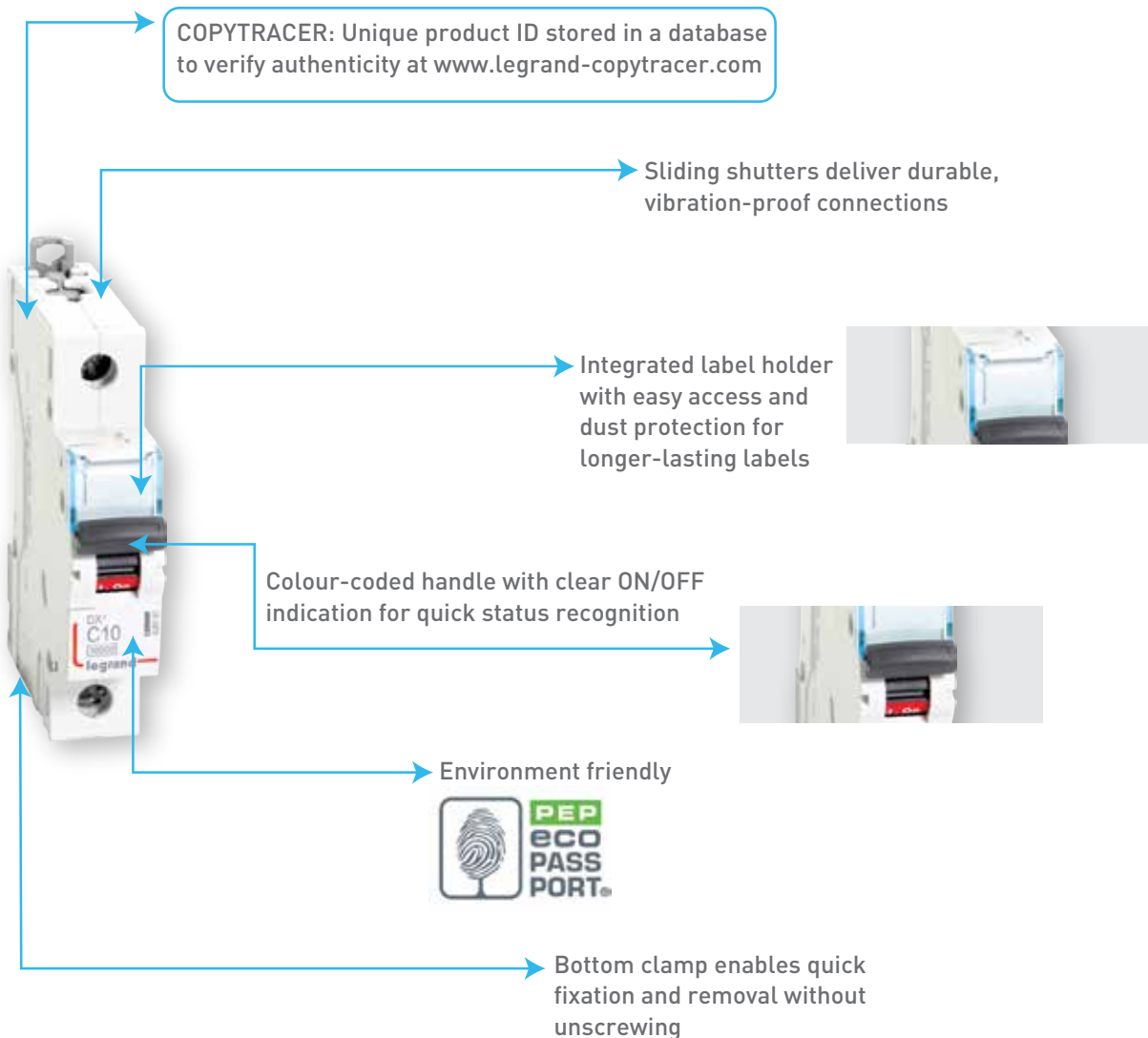

## Range

The DX<sup>3</sup> range has a selection of electrical auxiliaries for monitoring and controlling circuits remotely

Auxiliary contacts and fault signal contacts, shunt trips, undervoltage releases, motorised controls and automatic reclosers.

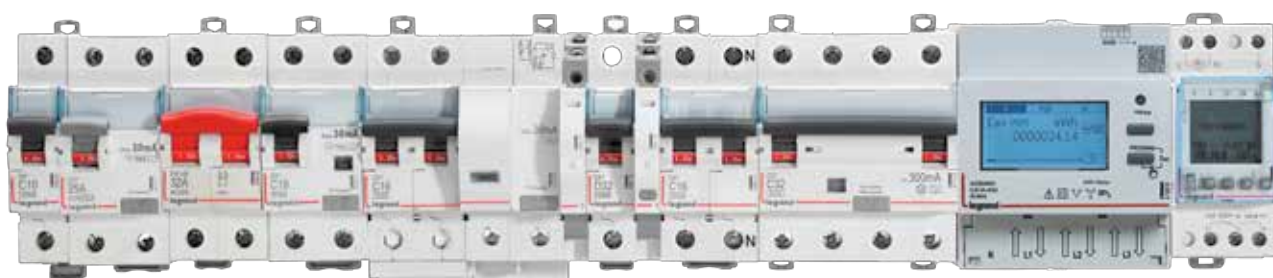

Scan to know more about the product.



## DX<sup>3</sup> AC MCBs

Cat.Nos	Nominal Rating	Number of 17.5 mm modules	MRP* ₹ / Unit	Pack
---------	----------------	---------------------------	---------------	------

### MCBs for AC Applications till 63A

10 kA ISI marked as per IS/IEC 60898-1 2002  
 Integrated label holder  
 Sliding bottom clamp  
 Efficient air channels  
 Color coded On/Off indication on dolly  
 Biconnect lower terminals  
 IP 20 protected terminals  
 Sliding shutters  
 Compatible with signal and control Auxiliaries

### DC-80 V per pole - 1 kA

#### C Curve

#### Single Pole 240/410V

4085 80	0.5	1	736	1/10/120
4085 81	1	1	736	1/10/120
4085 83	2	1	729	1/10/120
4085 84	3	1	729	1/10/120
4085 85	4	1	729	1/10/120
4085 87	6	1	449	1/10/120
4085 90	10	1	449	1/10/120
4085 92	16	1	449	1/10/120
4085 93	20	1	449	1/10/120
4085 94	25	1	449	1/10/120
4085 95	32	1	449	1/10/120
4085 96	40	1	1026	1/10/120
4085 97	50	1	1026	1/10/120
4085 98	63	1	1026	1/10/120



4085 90

#### Single Pole + Neutral 240V

4086 02	0.5	2	1925	1/5/60
4086 03	1	2	1925	1/5/60
4086 05	2	2	1925	1/5/60
4086 06	3	2	1925	1/5/60
4086 07	4	2	1925	1/5/60
4086 09	6	2	1362	1/5/60
4086 12	10	2	1362	1/5/60
4086 14	16	2	1362	1/5/60
4086 15	20	2	1362	1/5/60
4086 16	25	2	1362	1/5/60
4086 17	32	2	1362	1/5/60
4086 18	40	2	2203	1/5/60
4086 19	50	2	2203	1/5/60
4086 20	63	2	2203	1/5/60



4086 14

## DX<sup>3</sup> AC MCBs

Cat.Nos	Nominal Rating	Number of 17.5 mm modules	MRP* ₹ / Unit	Pack
---------	----------------	---------------------------	---------------	------

### Double Pole 415V

4086 21	0.5	2	1999	1/40
4086 22	1	2	1999	1/40
4086 24	2	2	1999	1/40
4086 25	3	2	1999	1/40
4086 26	4	2	1999	1/40
4086 28	6	2	1472	1/40
4086 31	10	2	1472	1/40
4086 33	16	2	1472	1/40
4086 34	20	2	1472	1/40
4086 35	25	2	1472	1/40
4086 36	32	2	1472	1/40
4086 37	40	2	2316	1/40
4086 38	50	2	2316	1/40
4086 39	63	2	2316	1/40



4086 37

### Triple Pole 415V

4086 43	0.5	3	2944	1/32
4086 44	1	3	2944	1/32
4086 46	2	3	2944	1/32
4086 47	3	3	2944	1/32
4086 48	4	3	2944	1/32
4086 50	6	3	2387	1/32
4086 53	10	3	2387	1/32
4086 55	16	3	2387	1/32
4086 56	20	3	2387	1/32
4086 57	25	3	2387	1/32
4086 58	32	3	2387	1/32
4086 59	40	3	3623	1/32
4086 60	50	3	3623	1/32
4086 61	63	3	3623	1/32



4086 55

### Triple Pole + Neutral 415V

4086 65	0.5	4	3735	1/32
4086 66	1	4	3735	1/32
4086 68	2	4	3735	1/32
4086 69	3	4	3735	1/32
4086 70	4	4	3735	1/32
4086 72	6	4	3112	1/32
4086 75	10	4	3112	1/32
4086 77	16	4	3112	1/32
4086 78	20	4	3112	1/32
4086 79	25	4	3112	1/32
4086 80	32	4	3112	1/32
4086 81	40	4	4451	1/32
4086 82	50	4	4451	1/32
4086 83	63	4	4451	1/32



4086 77

\* MRP - Maximum Retail Price Inclusive of all taxes including GST.

Bold Cat.Nos are products normally available with Legrand (India) Stockists. Cat.Nos that are not bold - delivery within 4 - 8 weeks from the date of order. Bold packing quantity is our mandatory packing. Orders to be placed by Legrand (India) Stockist in multiples of the same.

## DX<sup>3</sup> AC MCBs

Cat.Nos	Nominal Rating	Number of 17.5 mm modules	MRP* ₹ / Unit	Pack
---------	----------------	---------------------------	------------------	------

### Four Pole 415V

4086 84	0.5	4	3687	1/32
4086 85	1	4	3687	1/32
4086 87	2	4	3687	1/32
4086 88	3	4	3687	1/32
4086 89	4	4	3687	1/32
4086 91	6	4	3243	1/32
4086 94	10	4	3243	1/32
4086 96	16	4	3243	1/32
4086 97	20	4	3243	1/32
4086 98	25	4	3243	1/32
4086 99	32	4	3243	1/32
4087 00	40	4	4614	1/32
4087 01	50	4	4614	1/32
4087 02	63	4	4614	1/32



4086 94

## D Curve

### Single Pole 240/415V

4087 06	0.5	1	741	1/10/120
4087 07	1	1	741	1/10/120
4087 09	2	1	741	1/10/120
4087 10	3	1	741	1/10/120
4087 11	4	1	741	1/10/120
4087 12	6	1	616	1/10/120
4087 14	10	1	616	1/10/120
4087 16	16	1	616	1/10/120
4087 17	20	1	616	1/10/120
4087 18	25	1	616	1/10/120
4087 19	32	1	616	1/10/120
4087 20	40	1	■	1/10/120
4087 21	50	1	■	1/10/120
4087 22	63	1	■	1/10/120



4087 19

### Single Pole + Neutral 240V

4087 26	0.5	2	1925	1/5/60
4087 27	1	2	1925	1/5/60
4087 29	2	2	1925	1/5/60
4087 30	3	2	1925	1/5/60
4087 31	4	2	1925	1/5/60

### Double Pole 415V

4087 32	0.5	2	2017	1/40
4087 33	1	2	2017	1/40
4087 35	2	2	2017	1/40
4087 36	3	2	2017	1/40
4087 37	4	2	2017	1/40
4087 38	6	2	1525	1/40
4087 40	10	2	1525	1/40
4087 42	16	2	1525	1/40
4087 43	20	2	1525	1/40
4087 44	25	2	1525	1/40
4087 45	32	2	1525	1/40
4087 46	40	2	■	1/40
4087 47	50	2	■	1/40
4087 48	63	2	■	1/40



4087 46

\* MRP - Maximum Retail Price Inclusive of all taxes including GST.  
 ■ Price available on request.

## D Curve

Cat.Nos	Nominal Rating	Number of 17.5 mm modules	MRP* ₹ / Unit	Pack
---------	----------------	---------------------------	------------------	------

### Triple Pole 415V

4087 52	0.5	3	3004	1/32
4087 53	1	3	3004	1/32
4087 55	2	3	3004	1/32
4087 56	3	3	3004	1/32
4087 57	4	3	3004	1/32
4087 58	6	3	2461	1/32
4087 60	10	3	2461	1/32
4087 62	16	3	2461	1/32
4087 63	20	3	2461	1/32
4087 64	25	3	2461	1/32
4087 65	32	3	2461	1/32
4087 66	40	3	■	1/32
4087 67	50	3	■	1/32
4087 68	63	3	■	1/32



4087 52

### Triple Pole + Neutral 415V

4087 72	0.5	4	3662	1/32
4087 73	1	4	3662	1/32
4087 75	2	4	3662	1/32
4087 76	3	4	3662	1/32
4087 77	4	4	3662	1/32

### Four Pole 415V

4087 78	0.5	4	3652	1/32
4087 79	1	4	3652	1/32
4087 81	2	4	3652	1/32
4087 82	3	4	3652	1/32
4087 83	4	4	3652	1/32
4087 84	6	4	3220	1/32
4087 86	10	4	3220	1/32
4087 88	16	4	3220	1/32
4087 89	20	4	3220	1/32
4087 90	25	4	3220	1/32
4087 91	32	4	3220	1/32
4087 92	40	4	■	1/32
4087 93	50	4	■	1/32
4087 94	63	4	■	1/32



4087 90

## Circuit Breakers AC Applications 80 - 125A

10 kA as per IEC 60947-2  
 Integrated label holder  
 Sliding insulating shield  
 Color coded contact indication window  
 IP 20 protected terminals  
 50 sq mm terminals

### Single Pole 230V / 400V

4085 99	80	1.5	3977	1/5/160
4086 00	100	1.5	4352	1/5/161
4086 01	125	1.5	4722	1/5/162



4086 00

Bold Cat.Nos are products normally available with Legrand (India) Stockists.  
 Cat.Nos that are not bold - delivery within 4 - 8 weeks from the date of order.  
 Bold packing quantity is our mandatory packing. Orders to be placed by Legrand (India) Stockist in multiples of the same.

### DX<sup>3</sup> MCBs

Cat.Nos	Nominal Rating	Number of 17.5 mm modules	MRP* ₹ / Unit	Pack
---------	----------------	---------------------------	---------------	------

#### Double Pole 230V / 400V\*

4086 40	80	3	8814	1/5/60
4086 41	100	3	9393	1/5/60
4086 42	125	3	10228	1/5/60

#### Triple Pole 400V\*

4086 62	80	4.5	14163	1/9
4086 63	100	4.5	15086	1/9
4086 64	125	4.5	16581	1/9

#### Four Pole 400V\*

4087 03	80	6	18264	1/9
4087 04	100	6	19030	1/9
4087 05	125	6	21319	1/9

### DX<sup>3</sup> DC MCBs

#### Circuit breakers DC applications upto 63A

6 kA as per IEC 60947-2  
 Integrated label holder  
 Sliding bottom clamp  
 Improved air channels  
 Color coded On/Off indication on dolly  
 Biconnect lower terminals  
 IP 20 protected terminals  
 Sliding shutters

#### Single Pole 250V

4087 98	0.5	1	1095	1/10/120
4087 99	1	1	1095	1/10/120
4088 01	2	1	1095	1/10/120
4088 02	3	1	1095	1/10/120
4088 03	4	1	1095	1/10/120
4088 04	6	1	906	1/10/120
4088 06	10	1	906	1/10/120
4088 08	16	1	906	1/10/120
4088 09	20	1	906	1/10/120
4088 10	25	1	906	1/10/120
4088 11	32	1	915	1/10/120
4088 12	40	1	1210	1/10/120
4088 13	50	1	1210	1/10/120
4088 14	63	1	1210	1/10/120

#### Double Pole 250V

4088 15	0.5	1	2284	1/5/60
4088 16	1	1	2284	1/5/60
4088 18	2	1	2284	1/5/60
4088 19	3	1	2284	1/5/60
4088 20	4	1	2284	1/5/60
4088 21	6	1	2118	1/5/60
4088 23	10	1	2118	1/5/60
4088 25	16	1	2118	1/5/60
4088 26	20	1	2118	1/5/60
4088 27	25	1	2118	1/5/60
4088 28	32	1	2118	1/5/60
4088 29	40	1	2498	1/5/60
4088 30	50	1	2498	1/5/60
4088 31	63	1	2498	1/5/60

\* MRP - Maximum Retail Price Inclusive of all taxes including GST.  
 ♦ For further details on product contact nearest Legrand Sales Office.

### DX<sup>3</sup> MCBs

Cat.Nos	Nominal Rating	Number of 17.5 mm modules	MRP* ₹ / Unit	Pack
---------	----------------	---------------------------	---------------	------

### DX<sup>3</sup> RDSO DC MCB

#### Single Pole

4088 32	0.5	1	1122	1/10/120
4088 33	1	1	1122	1/10/120
4088 34	1.5	1	1122	1/10/120
4088 35	1.6	1	1122	1/10/120
4088 36	2.5	1	1122	1/10/120
4088 37	3	1	821	1/10/120
4088 38	4	1	821	1/10/120
4088 39	5	1	998	1/10/120
4088 40	10	1	998	1/10/120
4088 41	15	1	998	1/10/120
4088 42	20	1	998	1/10/120
4088 43	25	1	998	1/10/120
4088 44	30	1	1139	1/10/120
4088 45	35	1	1139	1/10/120
4088 46	40	1	1267	1/10/120
4088 47	50	1	1267	1/10/120
4088 48	60	1	1267	1/10/120

### DX<sup>3</sup> Isolators

#### Isolators for AC Applications upto 125A

ISI marked as per IEC 60947-3  
 Integrated label holder  
 Ergonomic red color dolly  
 Sliding bottom clamp  
 Double break mechanism  
 Improved air channels  
 Color coded On/Off indication on dolly  
 Biconnect lower terminals  
 IP 20 protected terminals  
 Compatible with signal and control Auxiliaries  
 Sliding shutters

#### Double Pole 240V

4065 00	32	2	780	1/5/60
<b>4065 01</b>	40	2	858	1/5/60
<b>4065 02</b>	63	2	1134	1/5/60
4065 04	100	2	1557	1/5/60
4065 05	125	2	1771	1/5/60

#### Triple Pole 415V

4065 09	32	3	1405	1/40
<b>4065 10</b>	40	3	1507	1/40
<b>4065 11</b>	63	3	1794	1/40
4065 13	100	3	1980	1/40
4065 14	125	3	2284	1/40

#### Four Pole 415V

4065 18	32	4	1541	1/32
4065 19	40	4	1914	1/32
4065 20	63	4	2111	1/32
4065 22	100	4	2551	1/32
4065 23	125	4	2811	1/32

Bold Cat.Nos are products normally available with Legrand (India) Stockists.  
 Cat.Nos that are not bold - delivery within 4 - 8 weeks from the date of order.  
 Bold packing quantity is our mandatory packing. Orders to be placed by Legrand (India) Stockist in multiples of the same.

# RCD

## Advanced Protection for Human Safety and Fire Prevention



DX<sup>3</sup> RCDs provide fast, precise earth leakage protection that safeguards people from electric shock and helps prevent fire risks caused by faulty wiring or insulation. They integrate seamlessly within distribution boards, enabling reliable circuit monitoring, advanced control, and remote signalling through modular auxiliary devices.

### Features

- Earth leakage protection from 30 mA to 300 mA
- Clip-on auxiliary modules for signalling, shunt release, undervoltage protection, and motorized control
- Integrated test button and robust assembly for reliable fault detection

### Benefits

- Simplifies upgrades with tool-free auxiliary installation and modular compatibility
- Improves reliability through precise fault detection



### Variants

#### Type AC

Detects residual alternating currents for standard applications with sinusoidal fault currents

#### Type A

Detects AC and pulsating DC residual currents for circuits with electronic devices and rectifiers

#### Type S

Time-delayed tripping for selectivity with downstream RCDs

#### Type Hpi

High-immunity protection designed to prevent unwanted tripping in disturbed environments (generators, computers, printers)



Scan to know more about the product.

## RCCBs for AC Applications Upto 63A

Cat.Nos	Nominal Rating	Number of 17.5 mm modules	MRP* ₹ / Unit	Pack
---------	----------------	---------------------------	---------------	------

### DX<sup>3</sup> RCCBs

#### RCCBs for AC Applications Upto 63A

ISI marked as per IS 12640-1  
Integrated label holder  
Ergonomic Grey color dolly  
Sliding bottom clamp  
Compatible with signal and control Auxiliaries  
Color coded On/Off indication on dolly  
Biconnect lower terminals  
IP 20 protected terminals  
35 sq mm terminals  
Sliding shutters

#### Type - AC

Sensitive to residual alternating currents  
Use : standard applications

#### Double Pole 240V

##### 30 mA

4118 51	25	2	4565	1/5/60
4118 52	40	2	5300	1/5/60
4118 53	63	2	6515	1/5/60

##### 100 mA

4118 56	25	2	5028	1/5/60
4118 57	40	2	5807	1/5/60
4118 58	63	2	6914	1/5/60

##### 300 mA

4118 61	25	2	5114	1/5/60
4118 62	40	2	6100	1/5/60
4118 63	63	2	6942	1/5/60

#### Four Pole 415V

##### 30 mA

4118 76	25	4	6451	1/32
4118 77	40	4	6613	1/32
4118 78	63	4	7357	1/32

##### 100 mA

4118 81	25	4	6802	1/32
4118 82	40	4	6882	1/32
4118 83	63	4	8094	1/32

##### 300 mA

4118 86	25	4	7006	1/32
4118 87	40	4	7109	1/32
4118 88	63	4	8122	1/32

#### Type- S

Delayed trip for discrimination with other residual current devices.  
Use : for discrimination with a downstream device

#### Double Pole 415V, A-S

##### 300 mA

4118 66	25	2	9058	1/5/60
4118 67	40	2	9510	1/5/60
4118 68	63	2	9786	1/5/60

#### Four Pole 415 V, A-S

##### 300 mA

4118 91	25	4	10200	1/5/60
4118 92	40	4	10331	1/5/60
4118 93	63	4	10794	1/5/60

## RCCBs for AC Applications Upto 63A

Cat.Nos	Nominal Rating	Number of 17.5 mm modules	MRP* ₹ / Unit	Pack
---------	----------------	---------------------------	---------------	------

### Type HPI

Enhanced immunity to unwanted tripping in environments with disturbances. eg. diesels, computers, printers, etc.  
• Detects faults with DC components eg. thyristors, triac etc.

#### Double Pole 240V HPI

##### 30 mA

4118 71	25	2	9905	1/5/60
4118 72	40	2	10399	1/5/60
4118 73	63	2	10701	1/5/60

#### Four Pole 415V HPI

##### 30 mA

4118 96	25	4	11220	1/32
4118 97	40	4	11574	1/32
4118 98	63	4	11873	1/32

### DX<sup>3</sup> RCBOs

#### RCBOs Assembled for AC Applications upto 63A

ISI marked as per IS 12640-2  
Integrated label holder  
Ergonomic design  
Color coded On/Off indication on dolly  
Compatible with signal and control Auxiliaries  
Front face indication for earth leakage fault  
IP 20 protected terminals  
35 sq mm terminals  
Sliding shutters

#### Type - AC

Sensitive to residual alternating currents  
Use : standard applications

#### Double Pole 240V AC Type

##### 30 mA

4113 22	6	4	5812	1/32
4113 23	10	4	5812	1/32
4113 24	16	4	5812	1/32
4113 25	25	4	5812	1/32
4113 26	32	4	5812	1/32
4113 27	40	4	6983	1/32
4113 28	63	4	8508	1/32

##### 100 mA

4113 29	6	4	6991	1/32
4113 30	10	4	6991	1/32
4113 31	16	4	6991	1/32
4113 32	25	4	6991	1/32
4113 33	32	4	6991	1/32
4113 34	40	4	7926	1/32
4113 35	63	4	9147	1/32

##### 300 mA

4113 36	16	4	7213	1/32
4113 37	25	4	7213	1/32
4113 38	32	4	7213	1/32
4113 39	40	4	8133	1/32
4113 40	63	4	9163	1/32

Bold Cat.Nos are products normally available with Legrand (India) Stockists. Cat.Nos that are not bold - delivery within 4 - 8 weeks from the date of order. Bold packing quantity is our mandatory packing. Orders to be placed by Legrand (India) Stockist in multiples of the same.



4118 57



4118 77



4118 83



4118 93



4118 97



4113 24

## RCBOs Assembled for AC Applications Upto 63A

Cat.Nos	Nominal Rating	Number of 17.5 mm modules	MRP* ₹ / Unit	Pack
---------	----------------	---------------------------	---------------	------

### Four Pole 415V, AC Type 30 mA

4113 65	16	7	7781	1/16
4113 66	25	7	7781	1/16
4113 67	32	7	7781	1/16
4113 68	40	7	8167	1/16
4113 69	63	7	9368	1/16

### Four Pole 415V, AC Type 100 mA

4113 70	16	7	8770	1/16
4113 71	25	7	8770	1/16
4113 72	32	7	8770	1/16
4113 73	40	7	9099	1/16
4113 74	63	7	10013	1/16

### Four Pole 415V, AC Type 300 mA

4113 75	16	7	9122	1/16
4113 76	25	7	9122	1/16
4113 77	32	7	9112	1/16
4113 78	40	7	9547	1/16
4113 79	63	7	10189	1/16



4113 79

## RCBOs Compact for AC Applications

upto 32A, 6kA

Conforms to IEC 60947

Integrated label holder

Ergonomic design

Color coded On/Off indication on dolly

Front face indication for earth leakage fault

IP 20 protected terminals

35 sq mm terminals

Sliding shutters

### Type- AC

Sensitive to residual alternating currents

Use : standard applications

### Double Pole 240V, AC Type

30 mA

4113 90	6	2	6909	1/32
4113 91	10	2	6909	1/32
4113 92	16	2	6909	1/32
4113 93	20	2	6909	1/32
4113 94	25	2	6909	1/32
4113 95	32	2	6909	1/32



4113 94

300 mA

4113 97	6	2	7243	1/32
4113 98	10	2	7243	1/32
4113 99	16	2	7243	1/32
4114 00	20	2	7243	1/32
4114 01	25	2	7243	1/32
4114 02	32	2	7243	1/32

## RCBOs Compact for AC Applications

Cat.Nos	Description	Number of 17.5 mm modules	MRP* ₹ / Unit	Pack
---------	-------------	---------------------------	---------------	------

### Four Pole 415V, AC Type 30 mA

4114 18	10	4	9440	1/16
4114 19	16	4	9440	1/16
4114 20	20	4	9440	1/16
4114 21	25	4	9440	1/16

### Four Pole 415V, AC Type 300 mA

4114 23	10	4	10846	1/16
4114 24	16	4	10846	1/16
4114 25	20	4	10846	1/16
4114 26	25	4	10846	1/16

### Type HPI

Enhanced immunity to unwanted tripping in environments with disturbances. eg. diesel engines, computers, printers, etc.

• Detects faults with DC components eg. thyristors, trio etc.

### Double Pole 240V, HPI Type

30 mA

4114 15	25	2	13395	1/32
4114 16	32	2	13395	1/32

### Type A

Sensitive to residual alternating currents and residual currents with a DC component.

Use : special applications

- if it is possible that the fault currents are not purely sinusoidal (rectifier bridge, etc.)

### Four Pole 415V, A Type

30 mA

4114 28	10	4	10646	1/16
4114 29	16	4	10646	1/16
4114 30	20	4	10646	1/16
4114 31	25	4	10646	1/16

### Four Pole 415V, A Type

300 mA

4114 33	10	4	12001	1/16
4114 34	16	4	12001	1/16
4114 35	20	4	12001	1/16
4114 36	25	4	12001	1/16

## DX<sup>3</sup> RCD Add on Module

For 125A

Conform to IEC 61009-1

AC type : detect AC components faults

Hpi type : detect faults with AC and DC components, increased

Immunity to false tripping

For mounting on the right-hand side of 1.5 module per pole DX<sup>3</sup> MCBs

Easy & fast association mechanism

Terminal cover for locking

70 sq mm terminals

\* MRP - Maximum Retail Price Inclusive of all taxes including GST.

Bold Cat.Nos are products normally available with Legrand (India) Stockists. Cat.Nos that are not bold - delivery within 4 - 8 weeks from the date of order. Bold packing quantity is our mandatory packing. Orders to be placed by Legrand (India) Stockist in multiples of the same.

## DX<sup>3</sup> RCD Add on Module



4105 68

Cat.Nos	Nominal Rating	Number of 17.5 mm modules	MRP* ₹ / Unit	Pack
---------	----------------	---------------------------	---------------	------

### Double pole 240V, AC type

#### 30 mA

4105 68	125 A	4	20780	1
---------	-------	---	-------	---

#### 100 mA

4105 69	125 A	4	23433	1
---------	-------	---	-------	---

#### 300 mA

4105 71	125 A	4	23433	1
---------	-------	---	-------	---

### Four Pole 415V, AC Type

#### 30 mA

4106 25	125 A	4	30967	1
---------	-------	---	-------	---

#### 100 mA

4106 26	125 A	4	34604	1
---------	-------	---	-------	---

#### 300 mA

4106 29	125 A	4	34604	1
---------	-------	---	-------	---

### Double Pole 240V, HPI Type

#### 30 mA

4105 78	125 A	6	25957	1
---------	-------	---	-------	---

#### 100 mA

4105 79	125 A	6	29014	1
---------	-------	---	-------	---

#### 300 mA

4105 82	125 A	6	29014	1
---------	-------	---	-------	---

### Four Pole 415V, HPI Type

#### 30 mA

4106 38	125 A	6	42911	1
---------	-------	---	-------	---

#### 100 mA

4106 39	125 A	6	45306	1
---------	-------	---	-------	---

#### 300 mA

4106 42	125 A	6	45306	1
---------	-------	---	-------	---

## DX<sup>3</sup> Auxiliaries

### Auxiliaries Common for MCBs, Isolators, RCCBs & RCBOs

Easy & fast fixation on site

On site clip on mounting

Clip on fitting on left side

### Signalling Auxiliaries



4105 78



4062 50



4062 52

4062 50	Auxiliary changeover switch 6 A	0.5	1490	1
4062 52	Fault signalling changeover switch 6 A	0.5	1737	1
4062 64	Changeover + fault signalling switch	1	2751	1

\* MRP - Maximum Retail Price Inclusive of all taxes including GST.

## DX<sup>3</sup> Auxiliaries



4062 78



4062 82

Cat.Nos	Description	Number of 17.5 mm modules	MRP* ₹ / Unit	Pack
---------	-------------	---------------------------	---------------	------

### Control Auxiliaries

4062 76	Shunt release 12 /48 V AC/ DC	1	3827	1
4062 78	Shunt release 110/415 V V AC	1	3827	1
4062 80	Undervoltage release 24/48 V AC/DC	1	3259	1
4062 82	Undervoltage release 230 V AC	1	3259	1

### Control Auxiliaries

4062 86	POP over voltage release	1	4154	1
4062 90	Motor control 24/48 V AC/ DC	1	14975	1
4062 91	Motor control 110/415 V AC	1	14975	1
4062 93	Motor control 24/48 V AC/ DC	2	28193	1
4062 95	Motor control 110/415 V AC	2	26629	1
4062 88	Automatic resetter	2	19886	1
4062 89	Automatic resetter with autotest	2	24888	1

### Rotary Handle

4063 19	Black rotary handle	-	3110	10
4063 20	Yellow/red rotary handle	-	3365	10

### Support for Padlock

4063 03	Support for padlock till 63 A	-	720	10
---------	-------------------------------	---	-----	----

### Sealable Screw Cover

4063 04	Devices upto 63 A	-	713	10
4063 06	For 80-125 A devices	-	1244	10

### 1/2 Module Spacing Unit

4063 07	1/2 module spacing unit	0.5	262	10
---------	-------------------------	-----	-----	----

### 5 mm Padlock

4063 13	5 mm Padlock	0.5	610	10
---------	--------------	-----	-----	----

Bold Cat.Nos are products normally available with Legrand (India) Stockists. Cat.Nos that are not bold - delivery within 4 - 8 weeks from the date of order. Bold packing quantity is our mandatory packing. Orders to be placed by Legrand (India) Stockist in multiples of the same.

## DX<sup>3</sup> Auxiliaries

Cat.Nos	Description	Number of 17.5 mm modules	MRP* ₹ / Unit	Pack
---------	-------------	---------------------------	---------------	------

### Manual Changer Switch

Compact design  
Manual switching operation  
Easy to assemble  
Ergonomic design

#### For 1 Mod/Pole Devices

4063 14	Manual change-over switch for DP	1	3531	5
4063 15	Manual change-over switch for TP	1	4078	5
4063 16	Manual change-over switch for FP	1	4531	5

## DX<sup>3</sup> RCD add on Module

### With Measurement & Metering

Cat.Nos	Nominal Rating	Number of 17.5 mm modules	MRP* ₹ / Unit	Pack
---------	----------------	---------------------------	---------------	------

Conform to IEC 61009-1  
Hpi type: detect faults with AC and DC components, increased  
Immunity to false tripping  
Inbuilt measurement/metering option  
Measurement - V, A, F, PF, KWh, KVA, KVAh, THD  
Metering - V, A, F, KWh  
RS 485 port for remote reading  
Di-electric test button inbuilt  
Ergonomic test button  
Scroll button for easy readings  
RLCD display on front facia  
For mounting on the right-hand side of 1.5 module per pole DX3 MCBs  
Easy & fast association mechanism  
70 sq mm terminals

#### Adjustable Metering, Four Pole 415 V

4106 57	63 A	7	22772	1
4106 58	125 A	7	40861	1

#### Adjustable Measurement

4106 59	125 A	7	44518	1
---------	-------	---	-------	---

## DX<sup>3</sup> Time Switches

Cat.Nos	Description	No. of Modules	MRP* ₹ / Unit	Pack
---------	-------------	----------------	---------------	------

**For Switching an Electric Circuit (Lighting, Heating) on Or Off at Selected Times During a Pre-Programmed Time Period.**

### Alpharex3 Digital Time Swiches Weekly Time Switch

Time-saving programming by selection of daily blocks, daily blocks individually adjustable or selection from preset blocks Mo-Fr and Mo-Su  
Permanent ON or OFF  
Circuit anticipation  
Power reserve 3 years for date, time and switching program  
Accuracy +/- 1 sec./Day

\* MRP - Maximum Retail Price Inclusive of all taxes including GST.

## DX<sup>3</sup> Time Switches

Cat.Nos	Description	No. of Modules	MRP* ₹ / Unit	Pack
---------	-------------	----------------	---------------	------

0037 10	Power supply 230 V $\sim$ 50/60Hz 1 NO contact 250 V/50 Hz 16 A - cos $\phi$ = 1 28 programmes Shortest switching-time 1 min	1	7514	1
---------	--	---	------	---

### Multiple Functions - Daily or Weekly Time Switch Programme - 5 Years Clock Working Reserve

Programme settings: on daily or weekly basis  
15 languages  
A programme consists of a on and off time and their assignement to certain days  
Option to suspend the programme for a specific period to set-up with start and date  
Minimum programme setting: 1 s.  
High precision clock:  $\pm$  0.1 sec per day  
Particularly suited to irregular cycles:  
- security installations (access point, alarms, etc.),  
- industrial installations (pump stations, etc.)  
Programmed directly on keypad, or using program transfer key Cat.No 4 128 72  
Additional functions including random (irregular cycles), hour counters

4126 31	1 output 16 A - 250 V $\sim$ - 50/60 Hz 56 programmes 1 Channel	2	8765	1
4126 41	2 output 16 A - 250 V $\sim$ - 50/60Hz 2x28 programmes 2 Channel	2	12451	1



4126 41

### Digital Time Switch with Astronomical Function

- For switching on/off lights and other electric devices according to the rising/setting of the sun
- With combination function for creating switching programs in which the devices are switched according to astronomical time and/or fixed preset times
- Daily astronomical calculation of the sunrise/sunset times based on the entered location or location coordinates

4126 54	1 output 16 A - 250 V $\sim$ 50/60 Hz Astronomical function 56 Programmes 1 Channel	2	15512	1
4126 57	2 output 16 A - 250 V $\sim$ 50/60 Hz Astronomical function 2x28 programmes 2 Channel	2	17702	1



4126 54



4126 57

### Alpharex<sup>3</sup> Yearly Time Switch

- Yearly and weekly time switch with additional astronomical function for all channels
- 84 switching programs per channel, comprising:
  - 28 weekly programs
  - 28 yearly programs
  - 28 special programs (priority program)

4126 30	2 outputs - 230 V $\sim$ 50/60 Hz Astronomical function 2 x 3 x 28 = 168 programmes	2	29037	1
---------	---	---	-------	---

Bold Cat.Nos are products normally available with Legrand (India) Stockists. Cat.Nos that are not bold - delivery within 4 - 8 weeks from the date of order. Bold packing quantity is our mandatory packing. Orders to be placed by Legrand (India) Stockist in multiples of the same.



4106 57

## Dx<sup>3</sup> Time Switches

Cat.Nos	Description	MRP* ₹ / Unit	Pack
<b>Programming Accessories</b>			
4128 72	<b>Programming transfer key</b> Can be used to store programme settings made: Directly on a multifunction and multi-programme time switch Cat.Nos 4 126 30/31/32/33/41/54/57 (loading on device) -with the programming software installed on a PC running Windows (loading on data loader)	3262	1
4128 73	<b>Programming software Kit</b> Can be used to create, save and transfer program settings for multi-function and multi-program time switches, Data is transferred to the program transfer key using the data loader connected to the USB port of the PC. 4128 73 Kit comprising software on CD-ROM, data loader and transfer key Windows XP, Windows 7, Windows 8 compatible"	6960	1

### Twilight Switches

- Light sensitive switches
- Can be used to switch a lighting circuit "ON" and "OFF" based on light conditions (nightfall, daybreak)
- Supplied with IP 65 weatherproof photoelectric cell
- Adjustable from 1 to 100 000 lux

4126 23	Luxo Switch / Light sensitive switch with Lux Sensor - Output 16 A 250 V~	11092	1
---------	---	-------	---

### MicroRex Analog Time Switches

Programmed via captive segment  
Power supply: 230 V~ 50/60 Hz  
3-position override switch "ON-AUTO-OFF" on front panel

Manual changeover to summer/winter time  
1 outlet 16 A - 250 V~ -  $\mu \cos = 1$

### Analog Time Switch Daily Programme

1 segment = 15 minutes

Accuracy:  $\pm 5$  minutes

1 outlet 16 A - 250 V~ -  $\mu \cos = 1$

4127 80	Vertical Dial N/O Contact - without working Reserve -Minimum switching time: 15 minutes	1	4571	1
4127 90	Vertical Dial N/O Contact - with 100 h working Reserve -Minimum switching time: 15 minutes	1	5383	1

\* MRP - Maximum Retail Price Inclusive of all taxes including GST.



4128 12

## Power Contactors / Modular Contactors CX<sup>3</sup>

Cat.Nos	Description	MRP* ₹ / Unit	Pack	
4128 12	Horizontal Dial Changeover Switch - without working Reserve -Minimum switching time: 15 minutes	3	6768	1
4128 13	Horizontal Dial Changeover Switch - with 100 h working Reserve -Minimum switching time: 15 minutes	3	8383	1

### Analog Time Switch Weekly Programme

1 segment = 2 hours

Accuracy:  $\pm 30$  minutes

1 outlet 16 A - 250 V~ -  $\mu \cos = 1$

4127 94	Vertical Dial N/O Contact - with 100 h working Reserve -Minimum switching time: 2 hours	1	5848	1
4127 95	Horizontal Dial Changeover Switch - with 100 h working Reserve -Minimum switching time: 4 hours	3	8470	1

## DX<sup>3</sup> Contactors

### Power Contactors / Modular Contactors CX<sup>3</sup>

Conform to IEC/EN 61095

Space for power supply busbar on top (up to 25 A)

Power contactors with 230 V~ coil and handle

Manual override for test and repair function, carried out via the handle

Permanent "ON" or "OFF" without automatic closing of the contactor

4125 44	25 A 2 NO contactor	3260	1
4125 45	40 A 2 NO contactor	5560	1
4125 47	63 A 2 NO contactor	6470	1
4125 48	63 A 2 NC contactor	6470	1
4125 49	40 A 3 NO contactor	9300	1
4125 50	63 A 3 NO contactor	10500	1
4125 51	25 A 4 NO contactor	3840	1
4125 53	40 A 4 NO contactor	9810	1
4125 56	63 A 4 NO contactor	11610	1
4125 57	63 A 4 NC contactor	11720	1

### Signalling Auxiliaries for Contactors

Auxiliary changeover switch

4124 29	For 1 module contactors 16 A to 25 A	4770	1
4124 30	For 2 module contactors 25 A	4790	1
4124 31	For 2 module contactors 25 A	6280	1

Bold Cat.Nos are products normally available with Legrand (India) Stockists. Cat.Nos that are not bold - delivery within 4 - 8 weeks from the date of order. Bold packing quantity is our mandatory packing. Orders to be placed by Legrand (India) Stockist in multiples of the same.

## DX<sup>3</sup> for Photovoltaic Applications

Cat.Nos	Description	MRP* ₹ / Unit	Pack
---------	-------------	---------------------	------

### DC MCBs

Breaking capacity 4.5 kA according to EN 60947-2

#### 800 V= Circuit Breakers

4144 24	6 A	9232	1
4144 25	8 A	9232	1
4144 26	10 A	9232	1
4144 27	13 A	9232	1
4144 28	16 A	9232	1
4144 29	20 A	9232	1

#### 1000 V= Circuit Breakers

4144 46	10 A	24738	1
4144 47	13 A	24738	1
4144 48	16 A	24738	1
4144 49	20 A	24738	1

### DC Rotary Handle Isolating Switches

Category of use DC 21B according to EN 60947-3

Double break contacts

#### 600 V= isolating switches

4142 61	16 A	10408	1
4142 62	25 A	11756	1
4142 63	32 A	11756	1

\* MRP - Maximum Retail Price Inclusive of all taxes including GST.

Cat.Nos	Description	MRP* ₹ / Unit	Pack
---------	-------------	---------------------	------

### 1000 V= Isolating Switches

4142 81	16 A	20154	1
4142 82	25 A	20110	1
4142 83	32 A	20902	1

### Accessories

4063 05	Pole separation divider	196	1
4063 07	Spacing unit 0.5 unit	262	10

Bold Cat.Nos are products normally available with Legrand (India) Stockists. Cat.Nos that are not bold - delivery within 4 - 8 weeks from the date of order. Bold packing quantity is our mandatory packing. Orders to be placed by Legrand (India) Stockist in multiples of the same.

# Surge Protective Devices (SPDs)

## Reliable Protection Against Lightning & Power Surges



Surge Protective Devices protect electrical installations from lightning-induced overvoltages and power surges. Designed for residential, commercial, industrial, and photovoltaic systems, they safely divert surge energy to earth to help maintain reliable and continuous power distribution.

### Features

- Type 1 and T1+T2 SPDs with impulse current capacity from 12.5 kA to 100 kA
- Type 2 SPDs with surge capacity from 20 kA to 45 kA
- PV and DC SPDs supporting photovoltaic systems up to 1500 V
- Plug-in modular design with status indicators for quick replacement and easy maintenance

### Benefits

- Prevents damage to costly electrical & electronic equipment
- Improves system reliability by reducing downtime and power interruptions
- Enables faster installation and maintenance with modular design
- Supports a wide range of electrical and solar power installations



#### T1 SPDs

are designed to provide protection in the main distribution board.

#### T1+T2 SPDs

are increasingly used at the supply end of installations and comply with the specifications of both T1 and T2 SPDs.

#### T2 SPDs

typically provide protection in secondary distribution boards or consumer units.

Scan to know more about the product.



## Low Voltage SPDs

Cat.Nos	Number of poles	Neutral position	I total (10/350)	Remote status monitoring (if any contact)	Number of modules	MRP* ₹ / Unit
---------	-----------------	------------------	------------------	---	-------------------	---------------

### SPDs for General Protection of Main Distribution Board

#### T1+T2 - limp 12,5 kA/pole T2 - 60 kA

4122 70	1P	-	12.5 kA	No	1	10582
4122 76 <sup>1</sup>	1P+N	Right	25 kA	Yes	2	18619
4122 71	2P	-	25 kA	No	2	20433
4122 72	3P	-	37.5 kA	Yes	3	25332
4122 77 <sup>1</sup>	3P+N	Right	50 kA	Yes	4	33944
4122 73	4P	-	50 kA	No	4	35000

#### T1+T2 - limp 8 kA/pole T2 - 60 kA

4122 50	1P	-	8 kA	No	1	■
4122 56 <sup>1</sup>	1P+N	Right	16 kA	No	2	■
4122 51	2P	-	16 kA	No	2	■
4122 52	3P	-	25 kA	No	3	■
4122 57 <sup>1</sup>	3P+N	Right	25 kA	No	4	■
4122 53	4P	-	32 kA	No	4	■

### SPDs for High Risk Level Installations

#### T1 - limp 35 kA/pole - 440 V± (IT) - Plug-in

4122 80	1P	-	35 kA	Yes	2	23419
---------	----	---	-------	-----	---	-------

#### T1 - limp 25 kA/pole

4122 81 <sup>1</sup>	1P+N	Right	50 kA	Yes	4	30429
4122 82	3P	-	75 kA	Yes	6	72748
4122 83 <sup>1</sup>	3P+N	Right	100 kA	Yes	8	83500

### Replacement Plug-In Modules

Cat.Nos	Description	MRP* ₹ / Unit	Pack
---------	-------------	---------------	------

4123 02	For SPDs T1+T2 - 8 kA Cat.Nos 4122 50/ 51/52/53/56/57	8314	1
4123 03	For SPDs T1+T2 - 12.5 kA Cat.Nos 4122 70/ 71/72/73/76/77	7844	1
4122 84	For SPDs T1 - 25 kA Cat.Nos 4122 81/82/83 and 0030 20/22/23/27	22791	1
4122 85	N-PE module for SPDs T1 - 25 kA Cat.Nos 4122 81/83 and 0030 23	30931	1
4122 86	For SPDs T1 - 35 kA Cat.No 4122 80	7644	1

## Low Voltage SPDs

Cat.Nos	Description	MRP* ₹ / Unit	Pack
---------	-------------	---------------	------

### Cabling Accessories

4123 10	Ready to use cabling kit consisting of 5 conductors (including the earth conductor) Cross section :16 mm <sup>2</sup> Lenght : 40 cm For cabling SPDs in industrial enclosures (for EN/IEC 61439 compliance).	1636	1
---------	--	------	---

### T2 SPDs

#### T2 - I<sub>max</sub> 40 kA/pole

4122 40	1P	-	No	1	■	1
4122 46 <sup>1</sup>	1P+N	Right	No	2	■	1
4122 41	2P	-	No	2	■	1
4122 42	3P	-	Yes	3	■	1
4122 47 <sup>1</sup>	3P+N	Right	No	4	■	1
4122 43	4P	-	No	4	■	1

#### T2 - I<sub>max</sub> 40 kA/pole - 440 V~ (IT)

4122 30	1P	-	No	1	■	1
4122 32	3P	-	Yes	3	■	1
4122 33	4P	-	Yes	4	■	1

#### T2 - I<sub>max</sub> 20 kA/pole

4122 20	1P	-	No	1	■	1
4122 26 <sup>1</sup>	1P+N	Right	No	2	■	1
4122 21	2P	-	No	2	■	1
4122 27 <sup>1</sup>	3P+N	Right	No	4	■	1
4122 23	4P	-	No	4	■	1

### Replacement Plug-In Modules

4122 99	For SPDs T2 - 40 kA Cat.Nos 4122 40/ 41/42/43/44/45/ 46/47/66/67	5401	1
4123 00	N-PE module for SPDs T2 - 40 kA Cat.Nos 4122 46/47	10813	1
4123 01	For SPDs T2 - 440 V Cat.Nos 4122 30/32/33	■	1
4122 97	For SPDs T2 - 20 kA Cat.Nos 4122 20/ 21/23/26/27/62/63	■	1

\* MRP - Maximum Retail Price Inclusive of all taxes including GST.  
■ Price available on request.



4122 57



4122 43



4122 83



4123 03



4122 84



4122 99

Bold Cat.Nos are products normally available with Legrand (India) Stockists. Cat.Nos that are not bold - delivery within 4 - 8 weeks from the date of order. Bold packing quantity is our mandatory packing. Orders to be placed by Legrand (India) Stockist in multiples of the same.

## Low Voltage SPDs

Without Short-Circuit Protection

Cat.Nos	Description	MRP* ₹ / Unit
---------	-------------	---------------------

### T1+T2 - limp 12.5 kA - Uc 385 VA

Up 1.9 kV, Uc 385 VA

Type 1 characteristics: limp 12.5 kA

Type 2 characteristics: In 30 kA and I<sub>max</sub> 60 kA

Neutral earthing systems: TT, TN

Protection against short-circuited end of life to be added: gG/gL fuse: 125 A

4103 70	Spd T1+T2/12.5kA 1P 385V	4860
4103 74	Spd T1+T2/12.5kA 1P+N 385V	7020
4143 74	Spdt1+T2/12.5kA1P+N 385v With Status Feedback	8100
4103 71	Spd T1+T2/12.5kA 2P 385V	9720
4103 72	Spd T1+T2/12.5kA 3P 385V	14580
4103 75	Spd T1+T2/12.5kA 3p+N 385V	16740
4143 75	SPD T1+T2/12.5kA 3P+N3 85V with Status Feedback	17820
4103 73	Spd T1+T2/12.5kA 4P 385V	19440



4103 73

### Protection for N-PE Application

#### T1+T2 - limp 25 kA - Uc 260 VA for 1P+N Installations

Up 1.4 kV, Uc 260 VA

Type 1 characteristics: limp 25 kA

Type 2 characteristics: In 30 kA and I<sub>max</sub> 60 kA

Neutral earthing systems: TT, TN

To be used in combination with one 1P varistor SPD

T1+T2 limp 12.5 kA Uc 175 VA or 385 VA

Cat. Nos 4 103 70 and 4 143 06 to protect the neutral branch

4103 10	1P GDT N-EAR SPD T1+T2/12.5kA	7020
---------	-------------------------------	------

#### T1+T2 - limp 50 kA - Uc 260 VA for 3P+N Installations

Up 1.5 kV, Uc 260 VA

Type 1 characteristics: limp 50 kA

Type 2 characteristics: In 30 kA and I<sub>max</sub> 60 kA

Neutral earthing systems: TT, TN

To be used in combination with three 1P varistor SPDs

T1+T2 limp 12.5 kA Uc 175 VA or 385 VA

Cat. Nos 4 103 70 and 4 143 06 to protect the neutral branch

4103 12	1P GDT N-EAR SPD T1+T2/12.5kA	7020
---------	-------------------------------	------

\* MRP - Maximum Retail Price Inclusive of all taxes including GST.

1 1P+N and 3P+N: L-N and N-PE protection modes (common and differential modes), the N pole being protected by encapsulated spark gaps. Also called sometimes 1+1 and 3+1

## Low Voltage SPDs

Without Short-Circuit Protection

Cat.Nos	Description	MRP* ₹ / Unit
---------	-------------	---------------------

### Plug-in Replacement Modules

4122 86	For T1+T2/35 kA SPDs	7644
4122 84	For T1+T2/25 kA SPDs	22791
4122 85	For T1+T2/25 kA SPDs (N-PE module)	30931
4103 01	Plugin Mod SPDT1+T2/12.5KA385V	3780
4103 11	Plugin Mod for 410310	5940
4103 13	Plug-In Module for 410310	5940



4122 84



4103 01



4103 13

### T1+T2 - T2 - I<sub>max</sub> 45 kA - Uc 460 VA

Up 2.5 kV, Uc 460 VA

Type 2 characteristic: In 10 kA, I<sub>max</sub> 20 kA

Neutral earthing systems: TT, TN, IT (PN < 120 V)

Protection against short-circuited end of life to be added: gG/gL fuse: 80 A

4143 60	SPD T2/45 kA1P 460V with Status Feedback	3780
4143 61	SPD T2/45 kA 2P 460V with Status Feedback	7020
4143 62	SPD T2/45 kA 3P 460V with Status Feedback	9990
4143 63	SPD T2/45 kA 4P 460V with Status Feedback	12960

### T2 - I<sub>max</sub> 45 kA - Uc 320 VA

Up 1.8 kV, Uc 320 VA

Type 2 characteristic: In 20 kA, I<sub>max</sub> 45 kA

Neutral earthing systems: TT, TN

Protection against short-circuited end of life to be added: gG/gL fuse: 80 A

4103 40	SPD T2/45 kA 1P 320V	2970
4103 44	SPD T2/45 kA 1P+N 320V	4050
4143 44	SPD T2/45 kA 1P+N 320V with Status Feedback	5130
4103 41	SPD T2/45 kA 2P 320V	5940
4103 42	SPD T2/45 kA 3P 320V	8910
4103 45	SPD T2/45 kA 3P+N 320V	9990
4143 45	SPD T2/45 kA 3P+N 320V with Status Feedback	11070
4103 43	SPD T2/45 kA 4P 320V	11880



4103 45

Bold Cat.Nos are products normally available with Legrand (India) Stockists. Cat.Nos that are not bold - delivery within 4 - 8 weeks from the date of order. Bold packing quantity is our mandatory packing. Orders to be placed by Legrand (India) Stockist in multiples of the same.

## Type 2 (T2) SPDs

Without Short-Circuit Protection

Cat.Nos	Description	MRP* ₹ / Unit	Pack
<b>T2 - I<sub>max</sub> 20 kA - Uc 460 VA</b>			
Up 2 kV, Uc 460 VA			
Type 2 characteristic: In 20 kA, I <sub>max</sub> 45 kA			
Neutral earthing systems: TT, TN, IT (PN < 120 V)			
Protection against short-circuited end of life to be added: gG/gL fuse: 80 A			
4143 50	SPD T2/20 kA 1P 460V with Status Feedback	3618	
4143 51	SPD T2/20 kA 2P 460V with Status Feedback	6156	
4143 52	SPD T2/20 kA 3P 460V with Status Feedback	8694	
4143 53	SPD T2/20 kA 4P 460V with Status Feedback	10152	

### SPDs Without Short-Circuit Protection

#### T2 - I<sub>max</sub> 20 kA - Uc 320 VA

Up 1.2 kV, Uc 320 VA

Type 2 characteristic: In 10 kA, I<sub>max</sub> 20 kA

Neutral earthing systems: TT, TN

Protection against short-circuited end of life to be added: gG/gL fuse: 80 A

4103 20	SPD T2/20 kA 1P 320V	2538	
4103 24	SPD T2/20 kA 1P+N 320V	3618	
4143 24	SPD T2/20 kA 1P+N 320V with Status Feedback	4698	
4103 21	SPD T2/20 kA 2P 320V	5076	
4103 22	SPD T2/20 kA 3P 320V	7614	
4103 25	SPD T2/20 kA 3P+N 320V	8694	
4143 25	SPD T2/20 kA 3P+N 320V with Status Feedback	9774	
4103 23	SPD T2/20 kA 4P 320V	10152	

### Plug-In Replacement Modules

4103 05	Plugin Mod for SPD T2/45 kA 460V	2700	
4103 04	Plugin Mod for SPD T2/45 kA 320V	2700	
4103 03	Plugin Module SPD T2/20 kA 460V	2160	
4103 02	Plugin Module SPD T2/20 kA 320V	2160	
4103 15	Plugin Mod for 410314	2700	
4103 17	Plug-In Module for 410316	2970	



## Type 2 (T2) SPDs

Without Short-Circuit Protection

Cat.Nos	Description	MRP* ₹ / Unit	Pack
---------	-------------	------------------	------

### Spark Gap SPDs Without Short-Circuit Protection for N-PE Applications

#### T2 - I<sub>max</sub> 20 kA - Uc 260 VA for 1P+N Installations

Up 2 kV, Uc 260 VA

Type 2 characteristic: In 20 kA, I<sub>max</sub> 45 kA

Neutral earthing systems: TT, TN

To be used in combination with one or three 1P varistor SPD T2 I<sub>max</sub> 20 kA Uc 175 VA or 385 VA

SPD T2 I<sub>max</sub> 20 kA Uc 175 VA or 385 VA

Cat. Nos 4 103 20/80 to protect the neutral branch

4103 14	1P GDT N-Earth SPD T2/20 kA 260V	2700	
---------	----------------------------------	------	--

#### T2 - I<sub>max</sub> 45 kA - Uc 260 VA for 1P+N Installations

Up 2 kV, Uc 260 VA

Type 1 characteristics: I<sub>imp</sub> 50 kA

Type 2 characteristics: In 30 kA and I<sub>max</sub> 60 kA

Neutral earthing systems: TT, TN

To be used in combination with one or three 1P varistor SPD T2 I<sub>max</sub> 45 kA Uc 175 VA or 385 VA

SPD T2 I<sub>max</sub> 45 kA Uc 175 VA or 385 VA

Cat. Nos 4 103 40/90 to protect the neutral branch

4103 16	1P GDT N-EAR SPD T2/45 kA 260V	3240	
---------	--------------------------------	------	--

### Plug-In Replacement Modules

4103 15	Plugin Mod for 410314	2700	
4103 17	Plug-In Module for 410316	2970	

### SPDs Without Short-Circuit Protection

#### T2 - I<sub>max</sub> 40 kA - Uc 1500 V<sub>~</sub>

Up 5 kV, Uc 1500 V<sub>~</sub>

Type 2 characteristic: In 18 kA, I<sub>max</sub> 40 kA

4103 58	SPD for PV T2/40 kA 1500V DC	9720	
---------	------------------------------	------	--

#### T2 - I<sub>max</sub> 40 kA - Uc 1040 V<sub>~</sub>

Up 3.5 kV, Uc 1040 V<sub>~</sub>

Type 2 characteristic: In 18 kA, I<sub>max</sub> 40 kA

4103 57	SPD for PV T2/40 kA 1040V DC	8640	
---------	------------------------------	------	--

### Plug-In Replacement Modules

4103 98	Plugin Mod PV SPD T2/40 kA 1500V DC	4320	
4103 97	Plugin Mod PV SPD T2/40 kA 1040V DC	3780	



# ACCL

Automatic Changeover with Current Limiter

## Seamless Power Switching for Smart Electrical Systems



ACCL ensures uninterrupted power by automatically switching between mains and generator supply. Designed with intelligent control and built-in current limiting, it protects the generator from overload while maintaining reliable power continuity for residential and commercial installations.

### Features

- Intelligent microcontroller-based design
- Built-in current limiter to prevent generator overload
- Break-before-make switching mechanism with neutral isolation
- LED status indicators with buzzer alerts and manual reset function

### Benefits

- Ensures continuous power supply during mains failure
- Protects generator systems from overload damage
- Improves safety through controlled and reliable power transfer
- Simplifies monitoring with clear visual and audible status alerts

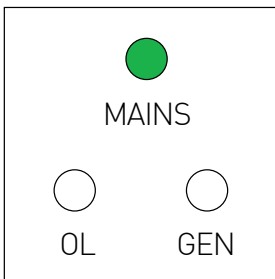

Mains ON

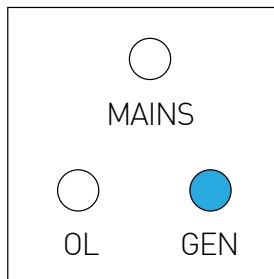

Genset ON

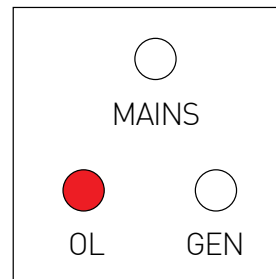

Overload



Scan to know more about the product.

## DX<sup>3</sup> Changeover Switches

Cat.Nos	Description	MRP* ₹ / Unit	Pack
---------	-------------	------------------	------

### Changeover Switches

#### Single Pole - Two Way - 250V AC

4129 00	32 A	4791	10/100
---------	------	------	--------

#### Double Pole - Two Way - 400V AC

4129 01	32 A	4791	5/50
---------	------	------	------

#### Double Pole - Two Way with Centre Off - 400V AC

4129 03	32 A	5016	5/50
---------	------	------	------

#### Four Pole - Two Way with Centre Off - 400V AC

6040 22	40 A	7769	2/20
---------	------	------	------

## Automatic Changeover with Current Limiter(ACCL)

Intelligent micro controller based design

Automatic source change over between Mains & Generator supply

Break before make change over system

Buzzer and Led Indication of status

Current limitation prevents overloading of the generator

4053 00	SPN 30/3A	3220	1/15
4053 01	SPN 30/4A	3220	1/15
4053 02	SPN 30/5A	3220	1/15
4053 03	SPN 30/6A	3220	1/15
4053 04	SPN 30/9A	3220	1/15
4053 05	SPN 30/12A	3220	1/15
4053 06	SPN 30/15A	3220	1/15
4053 07	SPN 30/20A	3220	1/15
4053 08	SPN 30/30A	3220	1/15

## DX<sup>3</sup> Push Button Push Button Cum Switch - 1 Module - 20A-250V AC

### Single Function

4129 08	Contact 1 NO	3958	10/100
4129 09	Contact 1 NC	3958	10/60
4129 10	Contact 2 NO	3958	10/60

\* MRP - Maximum Retail Price Inclusive of all taxes including GST.

## DX<sup>3</sup> Indicators

Cat.Nos	Description	MRP* ₹ / Unit	Pack
---------	-------------	------------------	------

### Dual Function

4129 14	Contact - 1 NO + green indicator	3958	10/60
4129 15	Contact - 1 NC + red indicator	3958	10/60

### Single Indicators - 1 Module - 250 V AC

Possible to replace E10 lamps and diffusers. E10 - 1.2 Watt, 230 V AC

4129 26	Colour - Green	1152	10/100
4129 27	Colour - Red	1152	10/100
4129 28	Colour - Orange	1152	10/100
4129 29	Colour - Blue	1152	10/100
4129 32	White + White + White	2102	10/100
4129 33	Red + Red + Red	2102	10/100
4129 34	Red + Yellow + Green	2102	10/100
4129 35	Red + Yellow + Blue	2141	10/100

### MaxiRex

6499 15	MaxiRex 4QT (daily)	9100	1/30
---------	---------------------	------	------

### EconoRex

0499 86	EconoRex MQT (24hrs.)	8803	1/30
---------	-----------------------	------	------

### Current Transformers

- Used with ammeters, electricity meters
- Supply a current of 5 A to the secondary which is proportional to the primary current.
- Fix to plate or rail EN 60715

4121 01	<b>50/5</b> Precision in % - 1 Power in VA - 1.5	3852	1/12
4121 03	<b>100/5</b> Precision in % - 1 Power in VA - 1.5	5240	1/12
4121 06	<b>200/5</b> Precision in % - 0.5 Power in VA - 4	5240	1/12
4121 24	<b>200/5</b> Precision in % - 0.5 Power in VA - 5	4960	1/12
4121 25	<b>400/5</b> Precision in % - 0.5 Power in VA - 8	5140	1/12
4121 36	<b>600/5</b> Precision in % - 0.5 Power in VA - 12	5220	1/12
4121 38	<b>800/5</b> Precision in % - 0.5 Power in VA - 8	7640	1/12
4121 39	<b>1000/5</b> Precision in % - 0.5 Power in VA - 10	8080	1/12
4121 42	<b>1250/5</b> Precision in % - 0.5 Power in VA - 12	9420	1/12

Bold Cat.Nos are products normally available with Legrand (India) Stockists. Cat.Nos that are not bold - delivery within 4 - 8 weeks from the date of order. Bold packing quantity is our mandatory packing. Orders to be placed by Legrand (India) Stockist in multiples of the same.

# Ekinox

Reinvent The New

Safety Styled for  
Modern Spaces



## MAKE A **SECOND** GLANCE

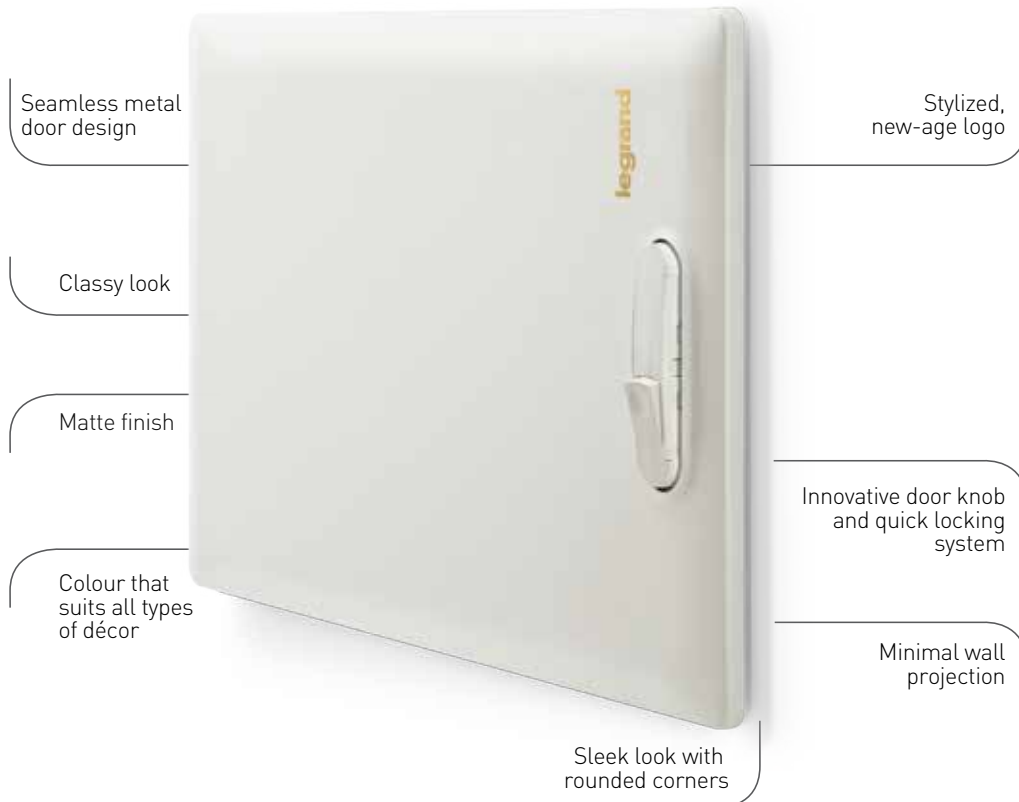

Scan to know more about the product.



## Features and benefits

Maximum reliability & excellent safety-  
Designed in accordance with IEC 61439-3



Integrated earthing system in order to avert risky contact



Completely insulated bus bars guarantee safety from severe shocks



Shrouded neutral bars and insulated din rail for complete isolation



Reversible door can be easily removed



Normal lock convertible to key lock, so that it isn't tampered with



Colour-coded neutral bars for easy identification



Plastic plugs for mounting holes

# Ekinox<sup>3</sup>™

## Distribution Board

## Built for Mivan Construction Environments



The Ekinox<sup>3</sup> Mivan Compatible Distribution Board is designed to simplify electrical installations in modern Mivan construction projects. Its robust construction and compact form factor support reliable installation within concrete wall systems while maintaining a clean and minimal appearance for finished interiors.

Scan to know more about the product.



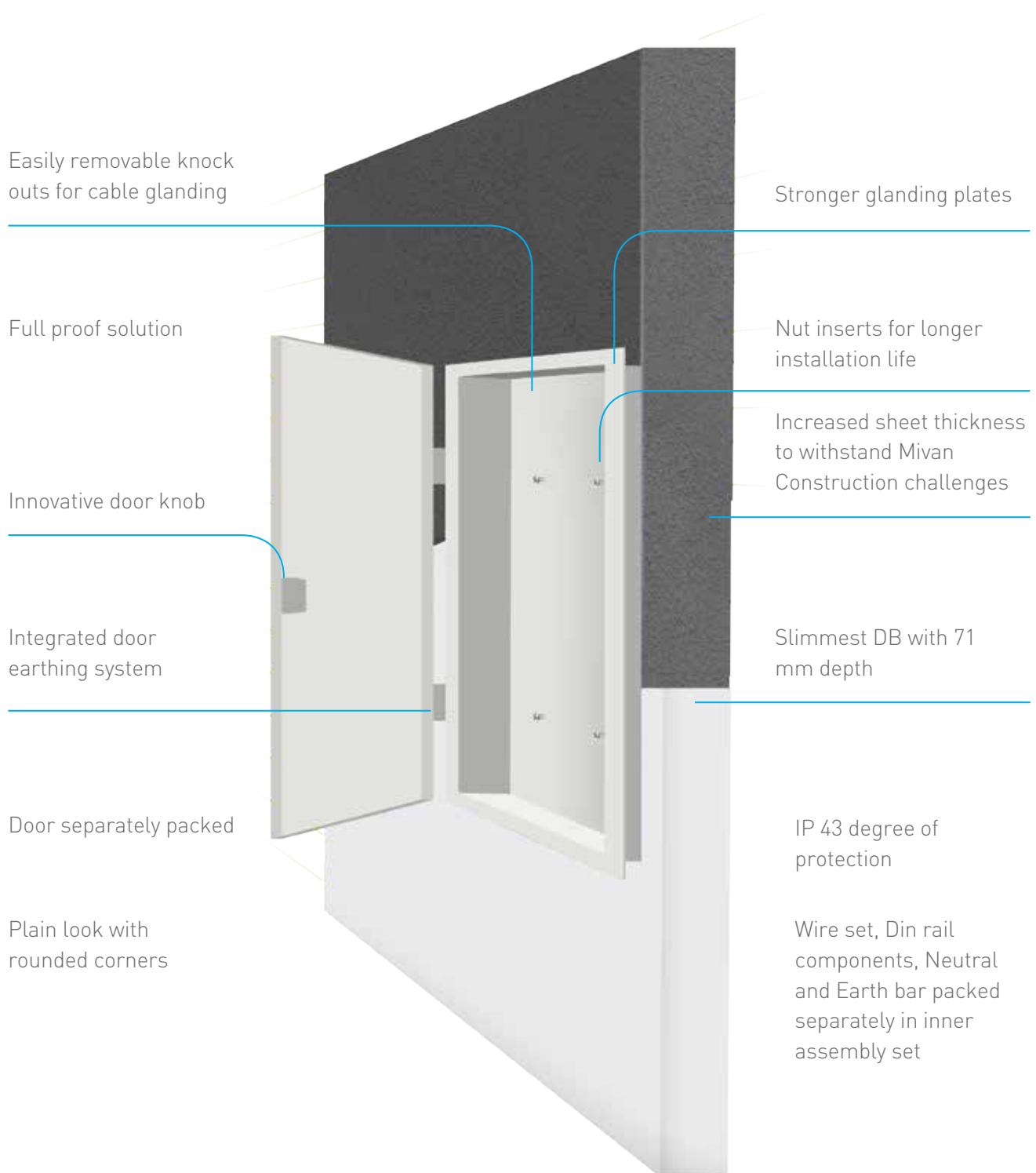

## Ekinox<sup>3</sup> SPN DB's

For DX<sup>3</sup> MCB, Isolator, RCCB and RCBO

Cat.Nos	Number ofWs	No. of modules	MRP* ₹ / Unit	Pack
---------	-------------	----------------	------------------	------

- As per IEC 61439-3
- Suitable for Flush Mounting and Surface Mounting
- With 100 A Copper Busbar
- With Neutral bar, Earthbar and Cable ties for Cable management
- Fully shrouded Neutral bars
- Prefitted masking sheet
- Reversible Door for IP 43 & IP 54 DB's

### IP 30 - #IK 08

5076 00	4W	4	2128	1
5076 01	8W	8	2581	1
5076 02	12W	12	3050	1
5076 03	16W	16	3726	1
5076 04	18W	18	4334	1
5076 05	20W	20	4834	1



5076 05



5076 12

### IP 43 - #IK 09 with Metal Door

5076 10	4W	4	2788	1
5076 11	8W	8	3597	1
5076 12	12W	12	4322	1
5076 13	16W	16	5415	1
5076 14	18W	18	5690	1
5076 15	20W	20	6573	1

### IP 43 - #IK 09 with Acrylic Door

5076 20	4W	4	3726	1
5076 21	8W	8	4316	1
5076 22	12W	12	5245	1
5076 23	16W	16	6514	1
5076 24	18W	18	6815	1
5076 25	20W	20	7216	1



5076 42

### IP 54 - #IK 09

5076 40	4W	4	9579	1
5076 41	8W	8	11386	1
5076 42	12W	12	13080	1
5076 43	16W	16	14525	1
5076 44	18W	18	14684	1
5076 45	20W	20	15958	1

## Ekinox<sup>3</sup> ETPN DB's

For DX<sup>3</sup> MCB, Isolator, RCCB and RCBO

- As per IEC 61439-3
- Suitable for Flush Mounting and Surface Mounting
- With 100 A Copper Busbar for each phase
- With Neutral bar, Earthbar and Cable ties for Cable management
- Fully insulated busbar & shrouded Neutral bars
- Improved Pan assembly for ease of installation
- Prefitted masking sheet
- Reversible Door for IP 43 & IP 54 DB's
- With provision for FP MCB/Isolator/RCCB/RCBO as incomer and SP MCB's as outgoing
- Supplied with wireset
- Can be converted to PPI DB at site using conversion kit

### IP 30 - #IK 08

5076 60	4W	8+12	6131	1
5076 61	6W	8+18	7605	1
5076 62	8W	8+24	8981	1
5076 63	12W	8+36	12805	1
5076 64	16W	8+48	15596	1
5076 66	20W	8+60	21766	1



5076 61



5076 82



5077 01



5077 11

## Ekinox<sup>3</sup> ETPN DB's

For DX<sup>3</sup> MCB, Isolator, RCCB and RCBO

Cat.Nos	Number ofWs	No. of modules	MRP* ₹ / Unit	Pack
---------	-------------	----------------	------------------	------

### IP 43 - #IK 09 with Metal Door

5076 70	4W	8+12	7335	1
5076 71	6W	8+18	8841	1
5076 72	8W	8+24	10593	1
5076 73	12W	8+36	15709	1
5076 74	16W	8+48	19664	1
5076 76	20W	8+60	27398	1

### IP 43 - #IK 09 with Acrylic Door

5076 80	4W	8+12	9237	1
5076 81	6W	8+18	11292	1
5076 82	8W	8+24	13289	1
5076 83	12W	8+36	20584	1
5076 84	16W	8+48	24787	1
5076 86	20W	8+60	33509	1

### IP 54 - #IK 09

5076 90	4W	8+12	22966	1
5076 91	6W	8+18	27636	1
5076 92	8W	8+24	30224	1
5076 93	12W	8+36	43009	1
5076 94	16W	8+48	51114	1
5076 96	20W	8+60	60809	1

## Ekinox<sup>3</sup> Flexy DB

For DX<sup>3</sup> DIN Modular Products

Cat.Nos	Number of row	No. of modules	MRP* ₹ / Unit	Pack
---------	---------------	----------------	------------------	------

- As per IEC 61439-3
- Suitable for Flush Mounting and Surface Mounting
- Completely flexible to organise the distribution as per site requirements
- Busbars to be selected as per distribution requirements
- With Neutral and Earth bars
- Fully shrouded Neutral bars
- Improved Pan assembly for ease of installation
- Prefitted masking sheet
- Reversible door for IP 43

### IP 30 - #IK 08

5077 01	2 row of 14 M	28	7433	1
5077 02	3 row of 14 M	42	9304	1
5077 03	4 row of 14 M	56	10317	1

### IP 43 - #IK 09 with Metal Door

5077 05	2 row of 14 M	28	9362	1
5077 06	3 row of 4 M	42	11191	1
5077 07	4 row of 14 M	56	12133	1
5077 14	4 row of 8 M	32	10351	1
5077 15	4 row of 10 M	40	10835	1
5077 12	3 row of 14 M MCCB for DPX <sup>3</sup> 160 MCCB	42	12881	1

### IP 43 - #IK 09 with Acrylic Door

5077 09	2 row of 14 M	28	9874	1
5077 10	3 row of 14 M	42	12135	1
5077 11	4 row of 14 M	56	13749	1
5077 13	3 row of 14 M MCCB for DPX <sup>3</sup> 160 MCCB	42	14330	1

Bold Cat.Nos are products normally available with Legrand (India) Stockists. Cat.Nos that are not bold - delivery within 4 - 8 weeks from the date of order. Bold packing quantity is our mandatory packing. Orders to be placed by Legrand (India) Stockist in multiples of the same.

### Ekinox<sup>3</sup> TPN DB-VTPN DB's For DX<sup>3</sup> MCB, Isolator, RCCB and RCBO

Cat.Nos	Number of Ws	No. of modules	MRP* ₹ / Unit	Pack
---------	--------------	----------------	------------------	------

- As per IEC 61439-3
- Suitable for Flush Mounting and Surface Mounting
- With 100 A Copper Busbar for each phase
- With 2 Neutral bar, 2 Earthbar and Cable ties for Cable management
- Fully insulated busbar & shrouded Neutral bars
- Improved Pan assembly for ease of installation
- Prefitted masking sheet
- Reversible Door for IP 43 & IP 54 DB's
- With provision for FP MCB/Isolator/RCCB/RCBO as incomer and SP/TP MCB's as outgoing

#### IP 30 - #IK 08

5077 20	4W	8+12	16452	1
5077 21	6W	8+18	18055	1
5077 22	8W	8+24	20084	1
5077 23	12W	8+36	28998	1

#### IP 43 - #IK 09 with Metal Door

5077 25	4W	8+12	17350	1
5077 26	6W	8+18	19215	1
5077 27	8W	8+24	22365	1
5077 28	12W	8+36	30090	1

#### IP 43 - #IK 09 with Acrylic Door

5077 30	4W	8+12	22512	1
5077 31	6W	8+18	24770	1
5077 32	8W	8+24	28964	1
5077 33	12W	8+36	38641	1

#### IP 54 - #IK 09

5077 35	4W	8+12	36085	1
5077 36	6W	8+18	39236	1
5077 37	8W	8+24	43403	1
5077 38	12W	8+36	56188	1

### Ekinox<sup>3</sup> TPN DB-VTPN DPX<sup>3</sup> 160 MCCB DB's

- As per IEC 61439-3
- Suitable for Flush Mounting and Surface Mounting
- With 250 A Copper Busbar for each phase
- With 2 Neutral bar, 2 Earthbar and Cable ties for Cable management
- Fully insulated busbar & shrouded Neutral bars
- Improved Pan assembly for ease of installation
- Prefitted masking sheet
- Reversible Door for IP 43 & IP 54 DB's
- With provision for DPX<sup>3</sup> 160 MCCB as incomer and SP/TP MCB's as outgoing

#### IP 30 - #IK 08

5077 40	4W	DPX <sup>3</sup> 160+12	18457	1
5077 41	6W	DPX <sup>3</sup> 160+18	19741	1
5077 42	8W	DPX <sup>3</sup> 160+24	21497	1
5077 43	12W	DPX <sup>3</sup> 160+36	32562	1

\* MRP - Maximum Retail Price Inclusive of all taxes including GST.  
#IK - Refer pg - 59 for ready reckoner table.  
■ Price available on request.

### Ekinox<sup>3</sup> TPN DB-VTPN DPX<sup>3</sup> 160 MCCB DB's

Cat.Nos	Number of Ws	No. of modules	MRP* ₹ / Unit	Pack
---------	--------------	----------------	------------------	------

#### IP 43 - #IK 09 with Metal Door

5077 45	4W	DPX <sup>3</sup> 160+12	21185	1
5077 46	6W	DPX <sup>3</sup> 160+18	24044	1
5077 47	8W	DPX <sup>3</sup> 160+24	26489	1
5077 48	12W	DPX <sup>3</sup> 160+36	36113	1

#### IP 54 - #IK 09

5077 50	4W	DPX <sup>3</sup> 160+12	42348	1
5077 51	6W	DPX <sup>3</sup> 160+18	48219	1
5077 52	8W	DPX <sup>3</sup> 160+24	52387	1
5077 53	12W	DPX <sup>3</sup> 160+36	69016	1

### Ekinox<sup>3</sup> TPN DB-VTPN DPX<sup>3</sup> 250 MCCB DB's

- As per IEC 61439-3
- Suitable for Flush Mounting and Surface Mounting
- With 250 A Copper Busbar for each phase
- With 2 Neutral bar, 2 Earthbar and Cable ties for Cable management
- Fully insulated busbar & shrouded Neutral bars
- Improved Pan assembly for ease of installation
- Prefitted masking sheet
- Reversible Door for IP 43 & IP 54 DB's
- With provision for DPX<sup>3</sup> 250 MCCB as incomer and SP/TP MCB's as outgoing

#### IP 30 - #IK 08

5077 55	4W	DPX <sup>3</sup> 250+12	29552	1
5077 56	8W	DPX <sup>3</sup> 250+24	31416	1
5077 57	12W	DPX <sup>3</sup> 250+36	34675	1

#### IP 43 - #IK 09 with Metal Door

5077 58	4W	DPX <sup>3</sup> 250+12	32495	1
5077 59	8W	DPX <sup>3</sup> 250+24	34268	1
5077 60	12W	DPX <sup>3</sup> 250+36	38723	1

#### IP 54 - #IK 09

5077 61	4W	DPX <sup>3</sup> 250+12	49957	1
5077 62	8W	DPX <sup>3</sup> 250+24	57090	1
5077 63	12W	DPX <sup>3</sup> 250+36	66715	1

Bold Cat.Nos are products normally available with Legrand (India) Stockists.  
Cat.Nos that are not bold - delivery within 4 - 8 weeks from the date of order.  
Bold packing quantity is our mandatory packing. Orders to be placed by Legrand (India) Stockist in multiples of the same.



5077 20



5077 31



5077 53



5077 55

### Ekinox<sup>3</sup> Mivan DB

Cat.Nos	Number of Ws	No. of modules	MRP* ₹ / Unit	Pack
---------	--------------	----------------	------------------	------

#### Ekinox<sup>3</sup> Mivan SPN DB

- As per IEC 61439-3
- Suitable for Mivan Construction
- With 100 A Copper Busbar
- With Neutral bar, Earthbar and Cable ties for Cable
- Fully shrouded Neutral bars
- Reversible Door

#### IP 43 - #IK 09 with Metal Door

5076 10M	4W	4	3029	1
5076 11M	8W	8	3967	1
5076 12M	12W	12	4975	1
5076 13M	16W	16	6038	1
5076 15M	20W	20	7572	1



5076 12

#### Ekinox<sup>3</sup> Mivan ETPN DB

- As per IEC 61439-3
- Suitable for Mivan Construction
- With 100 A Copper Busbar
- With Neutral bar, Earthbar and Cable ties for Cable
- Fully shrouded Neutral bars
- Reversible Door

#### IP 43 - #IK 09 with Metal Door

Cat.Nos	Description	No. of modules	MRP* ₹ / Unit	Pack
5076 70M	4W ETPN IP43 Mivan DB	8+12	7234	1
5076 71M	6W ETPN IP43 MIVAN DB	8+18	9967	1
5076 72M	8W ETPN IP43 MIVAN DB	8+24	11957	1
5076 73M	12W ETPN IP43 MIVAN DB	8+36	17568	1

- \* MRP - Maximum Retail Price Inclusive of all taxes including GST.
- Price available on request.

### Ekinox<sup>3</sup> PPI DB

Cat.Nos	Description	MRP* ₹ / Unit
---------	-------------	------------------

5076 70P	4W ETPN IP43 PPI DB	■
5076 71P	6W ETPN IP43 PPI DB	■
5076 72P	8W ETPN IP43 PPI DB	■
5076 73P	12W ETPN IP43 PPI DB	■
5076 74P	16W ETPN IP43 PPI DB	■
5076 76P	20W ETPN IP43 PPI DB	■

- Bold Cat.Nos are products normally available with Legrand (India) Stockists.
- Cat.Nos that are not bold - delivery within 4 - 8 weeks from the date of order.
- Bold packing quantity is our mandatory packing. Orders to be placed by Legrand (India) Stockist in multiples of the same.

# NEO

## Distribution Boards

### Sturdy & Robust Electrical Solution



#### Phase Selector Neo

Highly Compact

Sleek design

Easy to install –  
4 way construction Separate Door,  
Shield, Frame & Backbox

Integrated LED indication in the  
selector switches

IP 43 protection

Robust Design  
with - IK 09



#### 8 Segment Neo DB

Compact

Sturdy & Robust design

Colour coded Neutral Bar's

Ease of Installation with  
Detachable frame

8/7 compartments

Additional knockouts for  
ease of wiring

Representative Wiring  
Diagram on Door

IP42 & IK09



Scan to know more about  
the product.

## NEO DB

Cat.Nos	Description	MRP* ₹ / Unit	Pack
---------	-------------	------------------	------

### Phase Selector Neo DB

- As per IEC 61439-3
- Compact and sleek design
- IP 43 protection & IK 09
- Integrated LED indication in the selector switches
- With 100A copper busbar for each phase
- Fully insulated busbar & shrouded Neutral bars

5077 80N	4W NEO	19049	1
5077 81N	6W NEO	19357	1
5077 82N	8W NEO	20737	1
5077 83N	12W NEO	23354	1



5077 81N

### 8 Segment Neo DB

#### IP 42 - #IK 09 with Metal Door

- As per IEC 61439-3
- DB with phase segmentation and separation between Incomer and Outgoings
- Sturdy & Robust design
- With 100A copper busbar for each phase
- Colour coded Neutral Bars
- Easy to Install : Detachable frame
- 8 compartments
- More number of knockouts
- IP42 & IK09
- Supplied with wire-set
- With provision for DPX<sup>3</sup> 160 MCCB as incomer DP MCB/Isolator/RCCB/RCBO as sub incomers and SP MCB's as outgoing

5078 85N	4W 8/7S IP42 Neo	14681	1
5078 86N	6W 8/7S IP42 Neo	16447	1
5078 87N	8W 8/7S IP42 Neo	18423	1
5078 88N	12W 8/7S IP42 Neo	22936	1



5078 86N

#### IP 42- #IK09 Suitable for 160A DPX<sup>3</sup> MCCB as Incomer

5078 95N	4W 8/7S 160A MCCB IP42 Neo	20380	1
5078 96N	6W 8/7S 160A MCCB IP42 Neo	23313	1
5078 97N	8W 8/7S 160A MCCB IP42 Neo	26942	1
5078 98N	12W 8/7S 160A MCCB IP42 Neo	30418	1

### Ekinox<sup>3</sup> Metal Enclosures for DX<sup>3</sup> MCB, RCCB, RCBO and DPX<sup>3</sup> MCCB's

- As per IEC 61439-3
- Suitable for Flush Mounting and Surface Mounting
- Suitable for protection of appliances like AC/Geyser etc
- Supplied with Neutral Links
- With provision for mounting modular devices

#### #IK 08

5078 10	10 A SP, 2P+E	1	2771	1
5078 11	20 A SP, 2P+E	1	2985	1
5078 14	20 A DP, 2P+E	2	3243	1
5078 17	20 A TP, 3P+E	3	5494	1
5078 18	32 A TP, 3P+E	3	6518	1
5078 20	20 A DP RCBO, 2P+E	4	3137	1
5078 21	20 A FP RCBO, 2P+E	8	5485	1
5078 22	32 A FP RCBO, 3P+E	8	6466	1



5078 14



5078 22

\* MRP - Maximum Retail Price Inclusive of all taxes including GST.  
 # Price available on request.  
 #IK - Refer pg - 59 for ready reckoner table.

## Ekinox<sup>3</sup> Metal Enclosures

Cat.Nos	Description	No. of modules	MRP* ₹ / Unit	Pack
---------	-------------	----------------	------------------	------

- As per IEC 61439-3
- Suitable for Flush Mounting and Surface Mounting
- Supplied with Neutral Links
- With provision for mounting modular devices

#### #IK 08

5078 60	16 A 2P+E-DP	2	4525	1
5078 63	32 A 2P+E-DP	2	4891	1
5078 61	32 A 3P+E-FP	8	8188	1
5078 62	32 A 3P+N+E-FP	8	8283	1
5078 64	63 A 3P+N+E-FP	8	20618	1



5078 62



5078 64



5077 91



5077 93

### Ekinox<sup>3</sup> Metal Enclosures for DX<sup>3</sup> MCB, RCCB, RCBO & DPX<sup>3</sup> MCCB's

- As per IEC 61439-3
- For independent mounting of DX<sup>3</sup> MCB, RCCB, RCBO, DPX<sup>3</sup> 160, DPX<sup>3</sup> 250, DPX<sup>3</sup> 630 & DRX MCCB's
- #IK 08

#### #IK 08

5077 90	SP enclosure	1	761	1
5077 91	DP enclosure	2	1097	1
5077 92	TP enclosure	3	1097	1
5077 93	FP enclosure	4	1097	1
5077 94	FP RCBO enclosure	8	1835	1

#### Metal One Way Enclosures for MCCB

5078 01	DPX <sup>3</sup> 160 MCCB enclosure	3&4	6242	1
5078 02	DPX <sup>3</sup> 250 MCCB enclosure	3&4	10976	1
5078 04	DPX <sup>3</sup> 630 MCCB enclosure	3&4	17050	1
5078 05	DRX 100 MCCB enclosure-TP	3	3370	1
5078 06	DRX 100 MCCB enclosure-FP	4	3370	1

### Ekinox<sup>3</sup> Cable End Box

- Useful for keeping extra cables
- Possible to mount on the top or bottom of the DB
- Provision for mounting terminal blocks
- Can be used as a terminal box adaptor also

#### For IP 30 DB's

5079 10	For SPN 4 W IP30	1111	1
5079 12	For SPN 8 W IP30	1288	1
5079 14	For SPN 12 W/ VTPN/Flexy	1456	1
5079 16	For SPN 16 W/ ETPN 6W DB	2045	1
5079 25	For ETPN 8W DB	3673	1
5079 27	For ETPN 12W DB	4756	1
5079 29	For ETPN 16W DB	4850	1
5079 31	For ETPN 18W DB	5021	1
5079 33	For ETPN 20W DB	5198	1
5079 35	For ETPN 4W VTPN/FLEXY MCB	1442	1
5079 37	For all VTPN MCCB DBS	5313	1



5079 12



5079 16



5079 27

#### For IP 43 DB's

5079 11	For SPN 4W DB	1272	1
5079 13	For SPN 8W DB	1553	1
5079 15	For SPN 12W/ VTPN/Flexy DB	1741	1

Bold Cat.Nos are products normally available with Legrand (India) Stockists. Cat.Nos that are not bold - delivery within 4 - 8 weeks from the date of order. Bold packing quantity is our mandatory packing. Orders to be placed by Legrand (India) Stockist in multiples of the same.

## Ekinox<sup>3</sup> Metal Enclosures

Cat.Nos	Description	MRP* ₹ / Unit	Pack
---------	-------------	------------------	------

### For IP 43 DB's

5079 17	For SPN 16W/ ETPN 6W DB	2473	1
5079 18	For SPN 18W DB	2475	1
5079 19	For SPN 20/ETPN 8W DB	2585	1
5079 28	For ETPN 12W DB	5550	1
5079 30	For ETPN 16W DB	5656	1
5079 32	For ETPN 18W DB	5766	1
5079 34	For ETPN 20W DB	6100	1
5079 36	For all ETPN 4W/VTPN/Flexy MCB	1741	1
5079 38	For all VTPN MCCB DBs	6182	1

## Ekinox<sup>3</sup> DBs

### Meter Box

- Suitable for Mounting DX<sup>3</sup> Metering products
- Possible to mount on the top or bottom of the DB
- Provision for mounting Ammeter/Voltmeter/ASS/VSS
- #IK09

### Provision for Mounting Meters

5079 40	For VTPN MCB INCOM IP 30	6847	1
5079 41	For VTPN MCB INCOM IP 43	8402	1
5079 42	For VTPN MCCB INCOM IP 30	7615	1
5079 43	For VTPN MCCB INCOM IP 43	9697	1

### Per Phase Isolation Kit

5079 44	PPI conversion kit for ETPN 4W DB	4294	1
5079 45	PPI conversion kit for ETPN 6W DB	4842	1
5079 46	PPI conversion kit for ETPN 8W DB	5520	1
5079 47	PPI conversion kit for ETPN 12W DB	6212	1
5079 48	PPI conversion kit for ETPN 16W DB	6946	1

### Panel Locks

5079 52	Panel knob for IP 43	474	1
5079 51	Panel knob with key	989	1

## Distribution Boards Accessories

Cat.Nos	No. of devices connected	No. of 17.5 mm modules	MRP* ₹ / Unit	Pack
---------	--------------------------	------------------------	------------------	------

### Supply Busbars - Insulated

63 A Copper  
Pin Type

#### SP I/C & SP O/G

4049 26	13	13	515	1
4049 37	57	57	2001	1

\* MRP - Maximum Retail Price Inclusive of all taxes including GST.

▼ Compatible with Ekinox3 and NEO DB.

#IK - Refer pg - 59 for ready reckoner table.

## Distribution Boards

Cat.Nos	Description	MRP* ₹ / Unit	Pack
---------	-------------	------------------	------

### SPN I/C & SPN O/G

4049 46	6	12	904	1
4049 47	28	56	3740	1

### TPN I/C & SPN O/G

4049 48	5	12	929	3/30
4049 50	27	56	9129	5/10

### TP I/C & TP O/G

4049 51	4	12	936	1
4049 52	19	57	9177	1

### FP I/C & FP O/G

4049 54	3	12	2254	3/30
4049 55	14	56	9129	5/10

### Fork Type SP I/C & SP O/G

4049 56	13	12	515	1
4049 57	57	57	1964	1

### SPN I/C & SPN O/G250

4049 59	28	56	3740	1
---------	----	----	------	---

### TP I/C & TP O/G

4049 63	4	12	929	1
4049 64	19	57	4694	1

### FP I/C & FP O/G

4049 36	14	56	9129	5/10
---------	----	----	------	------

### Accessories for Fork and Pin Type Busbars

Cat.Nos	No. of devices connected	No. of 17.5 mm modules	MRP* ₹ / Unit	Pack
4049 89	End caps for SP	6	9	5/10

### Blanking Plates

Cat.Nos	Number of Ws	MRP* ₹ / Unit	Pack
6014 70	-	21	10

Bold Cat.Nos are products normally available with Legrand (India) Stockists. Cat.Nos that are not bold - delivery within 4 - 8 weeks from the date of order. Bold packing quantity is our mandatory packing. Orders to be placed by Legrand (India) Stockist in multiples of the same.

## Plexo<sup>3</sup> Boxes for DX<sup>3</sup>

Cat.Nos	Number ofWs	MRP* ₹ / Unit	Pack
---------	-------------	------------------	------

Self-extinguishing: resistance to incandescent wire 650 °C  
 Conform to EN 60439-3  
 Weatherproof cabinets - IP 65 - IK 09 - Class II  
 Door and cabinet fully reversible  
 Removable chassis and faceplates from 2-row versions up  
 2-position rail for modular products and moulded cases  
 Spacing between rails 150 mm  
 Box colour light grey L750A, cover colour dark grey  
 R746A

6019 32	2 (+1) Module	2581	1
6019 94	4 Module	2790	1
6019 96	6 Module	3186	1
6019 98	8 Module	3981	1

### Cabinets with 12 modules per row

6018 31	1 row 12 modules	6270	1
6018 32	2 rows 24 modules	8699	1
6018 33	3 rows 36 modules	12123	1

### Cabinets with 18 modules per row

6018 35	18 modules x 1 row	7733	1
6018 36	18 modules x 2 rows	13381	1
6018 37	18 modules x 3 rows	18814	1
6018 38	18 modules x 4 rows	28159	1

### Multifunction sleeves for P17

0019 17	For 2 row cabinets	4973	1
0019 18	For 3 row cabinets	7454	1
0019 67	Joining kit	1408	1

### Plexo-S

6018 82	Waterproof cabinet 2M	2063	1
6018 84	Waterproof cabinet 4M	2429	1
6018 86	Waterproof cabinet 6M	2792	1
6018 88	Waterproof cabinet 8M	3436	1
6018 92	Waterproof cabinet 12M	5511	1
6018 94	Waterproof cabinet 24M	7590	1

\* MRP - Maximum Retail Price Inclusive of all taxes including GST.  
 Refer instruction manual for MIVAN (Aluminum shuttering) compatible DB's  
 ■ Price available on request.

Note: For Plexo3 Box with integrated Neutral & Earth Bars contact nearest Sales Office

## Accessories

### Fixing Lugs And Blanking Plates

Cat.Nos	Number ofWs	MRP* ₹ / Unit	Pack
---------	-------------	------------------	------

0019 69	Set of 4 wall mounting lugs for Plexo, Plexo <sup>3</sup> cabinets and P 17 combined units	■	1
0019 61	5, seperable into modules or 1/2 module Grey RAL 7046	■	20

### Direct Piercing End Caps

0019 56	Pack consisting of 100 ø20 mm ISO and caps	■	1
0019 57	Pack consisting of 100 ø25 mm ISO and caps	■	1

### Earth Terminal & Neutral Terminal Blocks

**Brass terminal block with isolated support conform to IEC 60998-2-1/2-2**

1348 00	1 X (2x162 + 2x102); ICC : 6kA	■	1
1348 01	1 X (3x162 + 3x102); ICC : 6kA	■	1
1348 10	2 X (2x162 + 2x102); ICC : 6kA	■	1
1348 11	2 X (3x162 + 3x102); ICC : 6kA	■	1

Bold Cat.Nos are products normally available with Legrand (India) Stockists.  
 Cat.Nos that are not bold - delivery within 4 - 8 weeks from the date of order.  
 Bold packing quantity is our mandatory packing. Orders to be placed by Legrand (India) Stockist in multiples of the same.

# PLEXO

## Weatherproof Enclosures

### The Go-To Range for Reliable Outdoor Installations



PLEXO enclosures deliver durable, weatherproof protection for modular electrical installations across indoor and outdoor environments. Featuring award-winning design, quick snap-fit assembly, and flexible configurations, they ensure faster installations and reliable performance in demanding site conditions.

#### Features

- Reversible modular design supporting 1–7 module configurations with transparent or opaque covers
- Tool-free snap-fit assembly for quick installation and flexible alignment
- High protection ratings with IP55–IP66 sealing and IK07–IK09 impact resistance
- Durable, eco-compliant materials with 650°C self-extinguishing capability

#### Benefits

- Reduces installation time with fast snap-fit mounting and flexible wiring space
- Performs reliably in harsh environments like garages, car parks, and wash areas
- Enables quick visual inspection using transparent protective covers
- Supports scalable installations with modular designs and smart-ready options



Scan to know more about the product.



## Ekinox<sup>3</sup> For Converting ETPN DB to PPI DB

### PPI DB IP 30 - IK 08

No. of ways	Combine		No. of modules
	ETPN DB	PPI Kit	
4 way	4 way 507660	4 way kit 507944	8+12
6 way	6 way 507661	6 way kit 507945	8+18
8 way	8 way 507662	8 way kit 507946	8+24
12 way	12 way 507663	12 way kit 507947	8+36
16 way	16 way 507664	16 way kit 507948	8+48

### PPI DB IP 43 - IK 09 with metal door

No. of ways	Combine		No. of modules
	ETPN DB	PPI Kit	
4 way	4 way 507670	4 way kit 507944	8+12
6 way	6 way 507671	6 way kit 507945	8+18
8 way	8 way 507672	8 way kit 507946	8+24
12 way	12 way 507673	12 way kit 507947	8+36
16 way	16 way 507674	16 way kit 507948	8+48

### PPI DB IP 43 - IK 09 with acrylic door

No. of ways	Combine		No. of modules
	ETPN DB	PPI Kit	
4 way	4 way 507680	4 way kit 507944	8+12
6 way	6 way 507681	6 way kit 507945	8+18
8 way	8 way 507682	8 way kit 507946	8+24
12 way	12 way 507683	12 way kit 507947	8+36
16 way	16 way 507684	16 way kit 507948	8+48

### PPI DB IP 54 - IK 09

No. of ways	Combine		No. of modules
	ETPN DB	PPI Kit	
4 way	4 way 507690	4 way kit 507944	8+12
6 way	6 way 507691	6 way kit 507945	8+18
8 way	8 way 507692	8 way kit 507946	8+24
12 way	12 way 507693	12 way kit 507947	8+36
16 way	16 way 507694	16 way kit 507948	8+48

## IK

Protection against mechanical impact: protection index - IK

According to standard:

IEC 62262, BS EN 62262 and NF EN 62262

• This table can be used to ascertain the resistance of a product to an impact given in Joules from the IK code (graduated from 00 to 10)

It can also be used to ascertain the correspondence with the old IP code 3rd digit and the corresponding external "Ag" conditions

IK	Tests	Impact energy (in Joules)	"AG" of NF C 15-100
IK 00		0	
IK 01		0.15	
IK 02		0.2	AG1
IK 03		0.35	
IK 04		0.5	
IK 05		0.7	
IK 06		1	
IK 07		2	AG2
IK 08		5	AG3
IK 09		10	
IK 10		20	AG4

## IPXX

### Index of protection

IP\*\*\* index of protection of enclosures of electrical equipment in accordance with standards IEC 529, BS 5490, DIN 400 50 and NF C 20-010  
Up to 1000 V± and 1500 V= (standard UTE C 20 010)

#### 1st figure:- protection against solid bodies

IP	tests	
0		No protection
1		Protected against solid bodies larger than 50 mm (eg:- accidental contact with the hand)
2		Protected against solid bodies larger than 12 mm (eg:- finger)
3		Protected against solid bodies larger than 2.5 mm (eg:- tools, wires)
4		Protected against solid bodies larger than 1 mm (eg:- fine tools and small wires)
5		Protected against dust (no harmful deposit)
6		Completely protected against dust

#### 2nd figure:- protection against liquids

IP	tests	
0		No protection
1		Protected against vertically-falling drops of water (condensation)
2		Protected against drops of water falling at up to 15° from the vertical
3		Protected against drops of rain water at up to 60° from the vertical
4		Protected against projections of water from all directions
5		Protected against jets of water from all directions
6		Protected against jets of water of similar force to heavy seas
7		Protected against the effects of immersion
8		Protected against prolonged effects of immersion under pressure

The contents of all the above charts are for guidance only, if you have any doubt as to the interpretation of the information contained therein, please refer either to the standard itself or contact Legrand.

In accordance with our policy of continuous improvement, Legrand reserves the right to change specifications and designs without notice. All information given here is correct at the time of going to press.

# XCP-HP

## Sandwich BBT

### The High Performance Power Solution for Data Center Building & Industrial Application



XCP Sandwich Busbar Trunking is a compact power distribution system designed for high-current applications in large infrastructures such as skyscrapers, banks, data centers, and commercial buildings. Its sandwich construction enables efficient, safe, and reliable power distribution in space-constrained installations.

#### Features

- Wide current range from 630A to 6300A with copper and aluminium conductor options
- Designed for 50°C ambient condition
- Fire resistance up to 3 hours @830°C (IEC 60331-4) with high impact protection
- Halogen free
- Fully tested as per IEC 61439-6 standards
- Mechanical Impact tested IK10

#### Benefits

- Ensures safe and reliable power distribution in high-load buildings
- Optimises electrical riser and shaft space in large installations
- Minimises maintenance through durable, corrosion-resistant construction
- Supports faster project approvals with internationally compliant testing and performance standards

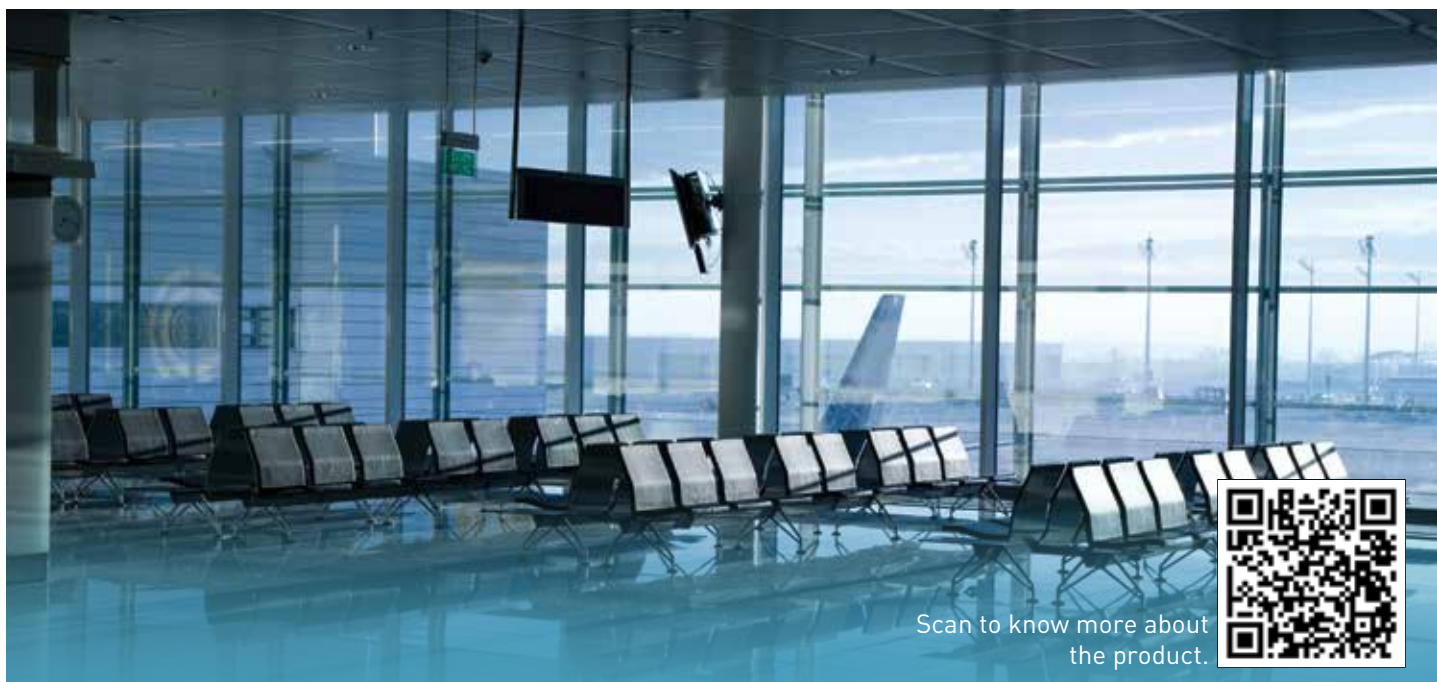

Scan to know more about the product.



# P17

## TEMPRA PRO

### Industrial Plugs & Sockets

## Weatherproof Power Connectivity for Harsh Environments



P17 Tempra Pro is a high-performance range of industrial plugs and sockets designed for demanding environments. With multiple weatherproof ratings and robust construction, the system ensures reliable power connectivity for environments such as airports, data centers, hotels, and outdoor installations.

### Features

- 16–125A range with IP44 to IP69 protection
- Rugged, weatherproof & chemical-resistant build
- Quick & easy installation design
- Flexible mounting & multiple configurations
- Ergonomic design with safety compliance (IEC standards)

### Benefits

- Works reliably in any environment (indoor/outdoor)
- Higher safety & secure connections
- Saves installation time & effort
- Low maintenance & long-lasting performance
- Adaptable for all project needs & applications



## Range

### IP44



Straight plugs



Mobile sockets



Panel mounting sockets



Surface mounting sockets

### IP66/67/69\*

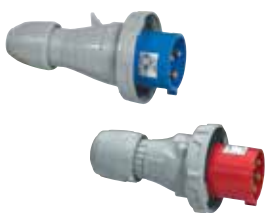

Straight plugs



Mobile sockets



Panel mounting sockets



Surface mounting sockets



Scan to know more about the product.



## P17 Tempra Pro IP 44 - LV 16 & 32A - Sockets & Plugs

Cat.Nos	Description	MRP* ₹ / Unit	Pack
---------	-------------	------------------	------

### Surface Mounting Sockets

5551 54	200/250 V~, 16 A 2P+E	971	10
5551 58	380/415 V~, 16 A 3P+E	1197	10
5551 59	380/415 V~, 16 A 3P+N+E	1268	10
5552 54	200/250 V~, 32 A 2P+E	1213	5
5552 58	380/415 V~, 32 A 3P+E	1518	10
5552 59	380/415 V~, 32 A 3P+N+E	1610	10



5552 58

### Panel Mounting Sockets Inclined Outlet

5551 84	200/250 V~, 16 A 2P+E	602	10
5551 88	380/415 V~, 16 A 3P+E	885	10
5551 89	380/415 V~, 16 A 3P+N+E	933	10
5552 84	200/250 V~, 32 A 2P+E	926	10
5552 88	380/415 V~, 32 A 3P+E	1170	10
5552 89	380/415 V~, 32 A 3P+N+E	1240	10



5551 88

### Mobile Sockets

5551 04	200/250 V~, 16 A 2P+E	784	10
5551 08	380/415 V~, 16 A 3P+E	873	10
5551 09	380/415 V~, 16 A 3P+N+E	926	10
5552 14	200/250 V~, 32 A 2P+E	1040	10
5552 18	380/415 V~, 32 A 3P+E	1249	10
5552 19	380/415 V~, 32 A 3P+N+E	1320	10



5551 08

### Straight Plugs

5551 24	200/250 V~, 16 A 2P+E	556	10
5551 28	380/415 V~, 16 A 3P+E	682	10
5551 29	380/415 V~, 16 A 3P+N+E	716	10
5552 34	200/250 V~, 32 A 2P+E	837	10
5552 38	380/415 V~, 32 A 3P+E	955	10
5552 39	380/415 V~, 32 A 3P+N+E	1012	10



5551 28

## P17 Tempra - Domestic Pin Configuration 16 A - 250 VA

### Flush-Mounting Boxes

0577 21	For 2 panel mounting sockets With single fixing centres 70 x 70 mm - 16 A	5499	3
0577 22	For 1 panel mounting socket With single fixing centres 70 x 70 mm - 16 or 32 A (32 A to be fixed horizontally)	3300	3



0577 22

\* MRP - Maximum Retail Price Inclusive of all taxes including GST.

## P17 Tempra Pro IP 66/67 LV 16 and 32 A

Cat.Nos	Polarity	MRP* ₹ / Unit	Pack
---------	----------	------------------	------

### Surface Mounting Sockets

5553 54	200/250 V~, 16 A 2P+E	1623	5
5553 58	380/415 V~, 16 A 3P+E	1806	5
5553 59	380/415 V~, 16 A 3P+N+E	1965	5
5554 54	200/250 V~, 32 A 2P+E	1924	5
5554 55	200/250 V~, 32 A 3P+E	3324	5
5554 59	380/415 V~, 32 A 3P+N+E	3602	5

### Panel Mounting Sockets

5553 84	200/250 V~, 16 A 2P+E	1188	5
5553 88	380/415 V~, 16 A 3P+E	1263	5
5553 89	380/415 V~, 16 A 3P+N+E	1343	5
5554 84	200/250 V~, 32 A 2P+E	1507	5
5554 88	380/415 V~, 32 A 3P+E	1726	5
5554 89	380/415 V~, 32 A 3P+N+E	1833	5

### Mobile Sockets

5553 04	200/250 V~, 16 A 2P+E	1452	5
5553 08	380/415 V~, 16 A 3P+E	1806	5
5553 09	380/415 V~, 16 A 3P+N+E	1917	5
5554 14	200/250 V~, 32 A 2P+E	1995	5
5554 18	380/415 V~, 32 A 3P+E	2132	5
5554 19	380/415 V~, 32 A 3P+N+E	2264	5

### Straight Plugs

5553 24	200/250 V~, 16 A 2P+E	1263	5
5553 28	380/415 V~, 16 A 3P+E	1386	5
5553 29	380/415 V~, 16 A 3P+N+E	1473	5
5554 34	200/250 V~, 32 A 2P+E	1710	5
5554 38	380/415 V~, 32 A 3P+E	1797	5
5554 39	380/415 V~, 32 A 3P+N+E	1906	5



5553 28

## P17 Tempra Pro IP 66/67 LV 32 A for Refrigerated Containers

### Combined Unit, Plug & Mobile Socket for Refrigerated Containers

6571 06	Combined unit with interlocked switched socket - Double mechanical interlock - Cable glands are not supplied	25411	1
---------	--	-------	---



6571 06

Bold Cat.Nos are products normally available with Legrand (India) Stockists. Cat.Nos that are not bold - delivery within 4 - 8 weeks from the date of order. Bold packing quantity is our mandatory packing. Orders to be placed by Legrand (India) Stockist in multiples of the same.

## P17 Tempra Pro IP 66/67 LV 32 A for Refrigerated Containers

Cat.Nos	Polarity	MRP* ₹ / Unit	Pack
---------	----------	------------------	------

### Combined Unit, Plug & Mobile Socket for Refrigerated Containers

5554 41	Straight plug With cable grip Ø12 to 21.5 mm	2066	5
---------	--	------	---

## P17 Tempra Pro IP 66/67 - LV 63 and 125 A

### Surface Mounting Sockets

5555 54	200/250 V~, 63 A 2P+E	6710	2
5555 58	380/415 V~, 63 A 3P+E	7013	2
5555 59	380/415 V~, 63 A 3P+N+E	7410	2
5556 58	380/415 V~, 125 A 3P+E	19446	2
5556 59	380/415 V~, 125 A 3P+N+E	20611	2



5555 59

### Panel Mounting Sockets

5555 84	200/250 V~, 63 A 2P+E	5324	2
5555 88	380/415 V~, 63 A 3P+E	5429	2
5555 89	380/415 V~, 63 A 3P+N+E	5718	2
5556 88	380/415 V~, 125 A 3P+E	15367	1
5556 89	380/415 V~, 125 A 3P+N+E	16432	1



5555 89

### Straight Plugs

5555 24	200/250 V~, 63 A 2P+E	4508	2
5555 28	380/415 V~, 63 A 3P+E	4678	2
5555 29	380/415 V~, 63 A 3P+N+E	5021	2
5556 28	380/415 V~, 125 A 3P+E	13634	1
5556 29	380/415 V~, 125 A 3P+N+E	14448	1



5555 29

### Mobile Sockets

5555 04	200/250 V~, 63 A 2P+E	5755	2
5555 08	380/415 V~, 63 A 3P+E	5974	2
5555 09	380/415 V~, 63 A 3P+N+E	6341	2
5556 08	380/415 V~, 125 A 3P+E	19845	1
5556 09	380/415 V~, 125 A 3P+N+E	21033	1



5555 09

## Plugs & Sockets

Cat.Nos	Polarity	MRP* ₹ / Unit	Pack
---------	----------	------------------	------

### P17 Combined Unit to be Equipped Bases with Mechanical Super-Compact Sockets

0573 00	16 A, 2P+E IP 44 Interlock	6719	1
0573 02	16 A, 3P+N+E IP 44 Interlock	7415	1
0573 20	16 A, 2P+E IP 55 Interlock	7537	1
0573 22	16 A, 3P+N+E IP 55 Interlock	8482	1
0577 23	Mounting plate for 2 super-compact mechanical interlock sockets	3774	1



0573 00

### Bases for 125 x 220 mm face plates

#### Example of combined unit configuration

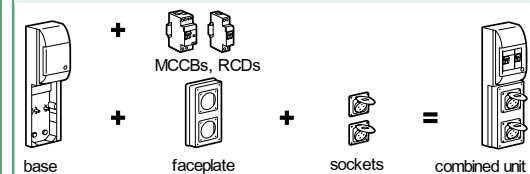

0577 10	Surface mounting box - upto 2 sockets	1571	2
0589 38	Surface mounting box with 5 module dinrail - upto 2 sockets	4391	1
0577 05	Surface mounting box with 12 module dinrail - upto 4 sockets	9702	1
0577 06	Surface mounting box with 18 module dinrail - upto 6 sockets	13580	1



0577 10



0577 05

### Face Plates 125 x 220 mm without Sockets

0577 12	For 1 x 16 A or 32 - upto A socket	1489	5
0577 13	For 2 x 16 A - upto sockets	1871	5
0577 17	For 1 x 63 A - upto sockets	1718	5
0577 15	Blanking Plate	1263	5



### Bases for 125 x 280 mm Face Plates

0577 11	Surface mounting box - upto 3 sockets	1636	3
0577 20	Surface mounting box with 5 module dinrail - upto 3 sockets	4712	1
0577 03	Surface mounting box with 12 module dinrail - upto 6 sockets	10057	1
0577 04	Surface mounting box with 18 module dinrail - upto 9 sockets	13989	1



0577 11



0577 04

\* MRP - Maximum Retail Price Inclusive of all taxes including GST.

Bold Cat.Nos are products normally available with Legrand (India) Stockists. Cat.Nos that are not bold - delivery within 4 - 8 weeks from the date of order. Bold packing quantity is our mandatory packing. Orders to be placed by Legrand (India) Stockist in multiples of the same.

## Plugs and Sockets

Cat.Nos	Polarity	MRP* ₹ / Unit	Pack
<b>Face Plates 125 x 280 mm without Sockets</b>			
0577 18	For 2 x 16 A and / or 32 A sockets	2339	4
0577 19	For 1 x 16 A or 32 A socket and 1 x 63 A socket	2199	2
0577 14	For 3 x 16 A sockets	2665	4
0577 16	Blanking plate	1485	4

## Hypra Industrial Plugs & Sockets

### Sockets

#### Prisinter Panel Mounting Sockets - IP 44, IK 09

0520 02	230 V, 16 A, 2P+E	13680	1/10
0527 02	230 V, 32 A, 2P+E	14916	1/6
0529 03	415 V, 32 A, 3P+E	15217	1/6
0529 04	415 V, 32 A, 3P+N+E	18078	1/6
0536 04	415 V, 63 A, 3P+N+E	58211	1

#### Panel Mounting Sockets - Inclined IP 44, IK 09

0522 23	415 V, 16 A, 3P+E	2213	5/50
0538 23	415 V, 63 A, 3P+E	7327	1

### Plugs

#### Straight Plugs - IP 44, IK 09

0520 42	250 V, 16 A, 2P+E	2402	5/50
0527 42	250 V, 32 A, 2P+E	2965	1/5
0522 43	415 V, 16 A, 3P+E	3955	5/50
0529 43	415 V, 32 A, 3P+E	3969	5/50
0529 44	415 V, 32 A, 3P+N+E	4391	5/15
0538 43	415 V, 63 A, 3P+E	10484	1/5
0538 44	415 V, 63 A, 3P+N+E	14087	1/5

## Metra Plugs & Sockets

### Plugs

#### Ivory

6500 22	240 V, 10 A, 2P+E	260	1/5/100
6500 28	240 V, 20 A, 2P+E	273	1/5/100

#### Grey

6500 02	240 V, 10 A, 2P+E	260	1/5/100
6500 08	240 V, 20 A, 2P+E	273	1/5/100
6500 10	440 V, 20 A, 3P+E	364	1/5/100
6500 16	440 V, 32 A, 3P+E	685	1/5/100

### Sockets

6500 03	240 V, 10 A, 2P+E With blue cap	264	1/5/100
6500 23	240 V, 10 A, 2P+E With ivory cap	264	1/5/100

\* MRP - Maximum Retail Price Inclusive of all taxes including GST.

## Hypra Industrial Plugs and Sockets

Cat.Nos	Description	MRP* ₹ / Unit	Pack
<b>Sockets</b>			
6500 09	240 V, 20 A, 2P+E With blue cap	303	1/5/100
6500 29	240 V, 20 A, 2P+E With ivory cap	303	1/5/100
6500 11	440 V, 20 A, 3P+E With red cap	407	1/5/100
6500 17	440 V, 32 A, 3P+E With red cap	685	1/5/100

## Plugs and Sockets

### P17 Tempra Combined Units

#### With Interlocked Switched Sockets & Surface Mounting Box IP 44

0566 01	250 V, 16 A, 2P+E	10091	1
0566 09	250 V, 32 A, 2P+E	12039	1
0566 13	415 V, 32 A, 3P+E	14559	1
0566 14	415 V, 32 A, 3P+N+E	15287	1

#### With Interlocked Switched Sockets and Surface Mounting Box IP 55

0566 21	250 V, 16A, 2P+E	11210	1
0566 29	250 V, 32 A, 2P+E	12805	1
0566 33	415 V, 32 A, 3P+E	16231	1
0566 34	415 V, 32 A, 3P+N+E	16527	1

#### With Interlocked Switched Sockets and Surface Mounting Box IP 44 with DIN Rail for 5 Module DX<sup>3</sup> Protection

0566 41	250 V, 16A, 2P+E	10764	1
0566 49	250 V, 32 A, 2P+E	13094	1
0566 53	415 V, 32 A, 3P+E	14478	1
0566 54	415 V, 32 A, 3P+N+E	15492	1

#### With interlocked Switched Sockets & Surface Mounting Box IP 66 with DIN Rail for 5 Module DX<sup>3</sup> Protection

0566 61	250 V, 16 A, 2P+E	12059	1
0566 69	250 V, 32 A, 2P+E	13992	1
0566 73	415 V, 32 A, 3P+E	15106	1
0566 74	415 V, 32 A, 3P+N+E	16331	1

#### With Interlocked Switched Sockets & Without Surface Mounting Box IP 55

0572 21	250 V, 16 A, 2P+E	9702	1
0572 29	250 V, 32 A, 2P+E	10970	1
0572 33	415 V, 32 A, 3P+E	13024	1
0572 34	415 V, 32 A, 3P+N+E	14227	1
0572 95	415 V, 63 A, 3P+N+E, IP 66	31046	1

### P17 tempra Combined Units

#### with Interlocked Switched Sockets IP 66

0589 18	380 to 415 V, 50/60 Hz, 63 A, 3P + E with provision for 5 module DX <sup>3</sup> protection	33064	1
0572 99	380 to 415 V, 50/60 Hz, 63 A, 3P+N+E with provision for 5 module DX <sup>3</sup> protection	37256	1

Bold Cat.Nos are products normally available with Legrand (India) Stockists. Cat.Nos that are not bold - delivery within 4 - 8 weeks from the date of order. Bold packing quantity is our mandatory packing. Orders to be placed by Legrand (India) Stockist in multiples of the same.



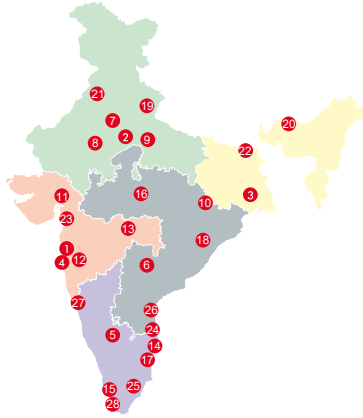

## Head offices

- 61 & 62, 6<sup>th</sup> Floor,  
Kalpataru Square, Kondivita Road,  
Off Andheri-Kurla Road, Andheri (E),  
**MUMBAI** – 400 059.  
Tel.: (022) 3041 6200  
Fax : (022) 3041 6201  
Website : www.legrand.co.in

## Regional sales offices

- B-225, 4<sup>th</sup> Floor, Okhla Industrial  
Area, Phase -1,  
**NEW DELHI** – 110020.  
Tel.: (011) 3990 2200 [INNOVAL](#)
- Ecocenter Ambuja Neotia,  
Block - EM-04, 12<sup>th</sup> Floor,  
Unit - 1203, Sector - V, Salt Lake,  
**KOLKATA** – 700 091.  
Tel.: (033) 4021 3535 / 3536 [INNOVAL](#)
- C/203, Corporate Avenue, Atul Projects,  
Near Mirador Hotel, Chakala,  
Andheri - Ghatkopar Link Road,  
Andheri - (E), **MUMBAI** – 400 099.  
Tel.: (022) 6230 1000 [INNOVAL](#)
- Ferozes Manor, 1<sup>st</sup> Floor, No. 58,  
Bowring Hospital Road,  
**BANGALORE** – 560 001.  
Tel.: (080) 80682 20000 [INNOVAL](#)
- Prestige Phoenix, 1<sup>st</sup> Floor,  
Survey number 199,  
Door No. 6-3-1219/J/101 & 102,  
Begumpet, **HYDERABAD**,  
Telangana - 500 016  
Tel.: (040) 4567 1717/2341 4398/234 14367 [INNOVAL](#)

## Branch offices

- Bestech Business Tower  
Unit no. 203, 2<sup>nd</sup> floor  
Tower -B, Sector -66,  
**MOHALI**- 160 062  
Tel.: (0172) 5019 008/ 4635 145 [INNOVAL](#)
- 128, Mohan Nagar besides  
Ridhi Siddhi Flyover, **JAIPUR** - 302019  
Tel.: 0141-220 8665 [INNOVAL](#)
- 209-A, 2<sup>nd</sup> Floor, Cyber Heights,  
Opp. Indira Gandhi Pratishthan,  
Vibhuti Khand, Gomti Nagar,  
**LUCKNOW** – 226 010.  
Tel.: (0522) 457 5427 [INNOVAL](#)
- 202 & 203, Sunrise, Forum 100,  
Burdwan Compound, Lalpur,  
**RANCHI** - 834 001.  
Tel.: (651) 660 5400
- A 101-102, Mondeal Heights,  
Besides Novotel Hotel, Sarkhej  
Gandhinagar Highway (S G Highway),  
**AHMEDABAD** – 380 015.  
Tel.: (079) 6134 0555 [INNOVAL](#)
- 8<sup>th</sup> Floor, Pinnacle Park Avenue,  
Opp. Law College, Law College Road  
Next To German Bakery,  
Shivaji Nagar, **PUNE** - 411004.  
Tel.: (020) 6729 5601 / 600 [INNOVAL](#)
- Plot No.95, 2<sup>nd</sup> Floor, Shreyash  
Heights, VIP Road, Ramdaspath,  
**NAGPUR** – 440 010.  
Tel.: (0712) 2440 900
- 10 B, Prestige Center Court, Office Block,  
Vijaya Forum Mall, #183,N.S.K. Salai,  
Vadapalani, **CHENNAI** – 600 026.  
Tel.: (044) 6612 2800 [INNOVAL](#)
- J. B. Manjooran Estate,  
Door No. 37/3484, 3<sup>rd</sup> Floor,  
Bye Pass Junction, Edappally,  
**COCHIN** – 682 024.  
Tel.: (0484) 2801921/6604700 [INNOVAL](#)
- 204-205, Megapolis Square,  
579, M G Road,  
**INDORE** – 452 001.  
Tel.: (0731) 49998 91/92/93
- MF-2, Datta's Lords House,  
Jamma Chettu Street, Mogalrajapuram,  
**VIJAYAWADA** – 520 010.  
Tel.: (0866) 2482393/6393

- Plot No. 359, Saheed Nagar,  
2<sup>nd</sup> Floor,  
**BHUBANESWAR** – 751 007.  
Tel.: (0674) 2540 623
- Unit - 1 & 2, Vijay Park,  
Main Chakrata Road,  
**DEHRADUN**- 248 001.  
Uttarakhand.  
Tel.: (0135) 661 6100 [INNOVAL](#)
- House No. 97, Ground Floor,  
Rajgarh Main Road,  
Opp. City Heart Nursing Home,  
**GUWAHATI** – 781 007.

## Area offices

- SCO 50-51, 2<sup>nd</sup> Floor Lodhi Club  
Road Shaheed Bhagat Singh  
Nagar, **LUDHIANA** – 141 013.  
Tel.: (0161) 463 8439 [INNOVAL](#)
- 94, Udhm Singh Sarani,  
Ground Floor, Ashrampara,  
**SILIGURI** – 734 001.  
Tel.: (353) 264 1067
- A-207, Universal Business  
Center, Near Madhwan Circle,  
L.P. Savani Road, Adajan,  
**SURAT** – 395 009.  
Tel.: (0261) 263 3861 [INNOVAL](#)
- Aparna Towers, 1<sup>st</sup> Floor, 2/3,  
Bypass Road,  
**MADURAI** – 625 010.  
Telefax : (0452) 230 8414
- 43-9-205, 3<sup>rd</sup> Floor, Plot No. 10,  
Subbalakshmi Nagar,  
Opp. More Super Market,  
**VISAKHAPATNAM** – 530 016.  
Tel.: (0891) 273 5652/9363 [INNOVAL](#)
- B-5, 1<sup>st</sup> Floor, Thirumalai Towers,  
723, Avanashi Road,  
**COIMBATORE** – 641 018.  
Tel.: (0422) 668 3200/222 3634 [INNOVAL](#)
- 515 & 516, Gera Imperium Grand,  
Patto centre ,  
Panaji **GOA** – 403 001 [INNOVAL](#)
- TC 25/3254/6, 1st Floor, Cordial Bharathi  
Nanthancodu, **Thiruvanthapuram**,  
KERALA- 695 003  
Tel.: (0471) 354 5052/353 8935 [INNOVAL](#)
- 2<sup>nd</sup> Floor, GND Chambers,  
Agrasen Chowk, Samta Colony,  
**RAIPUR** - 492001,Chattisgarh  
Tel.: (0771) 4052 400

## Technical assistance from Legrand

Telephonic technical assistance for selection of products, technical information, guidance, wiring diagrams and estimation is now made available to you at each Regional Office. Contact the Technical Officer of Legrand at the following telephone numbers

- New Delhi** : Tel.: (011) 3990 2200  
**Kolkata** : Tel.: (033) 4021 3535  
**Mumbai** : Tel.: (022) 6230 1000  
**Chennai** : Tel.: (044) 6612 2800  
**Hyderabad** : Tel.: (040) 4567 1717

For other places, contact the nearest  
Regional / Branch / Area offices

[customer.care@legrand.co.in](mailto:customer.care@legrand.co.in)

